

PALLMER

TREK
SHELVING
SPECIFICATION GUIDE
& PRICE LIST 2024

WOODS & FINISHES:

Natural Maple

Standard



Natural Clear – M-NA

Maple Finishes

The following stains are available, add 10% to list



Castle Oak – M-CO



Honey Oak – M-HO

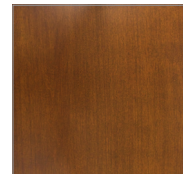

English Oak – M-EN

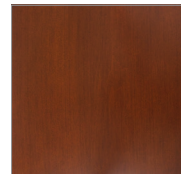

Victorian Cherry – M-VI



Richmond Cherry – M-RC

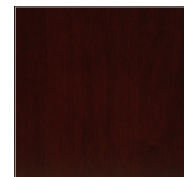

Mahogany – M-MA

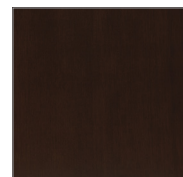

Java – M-JA

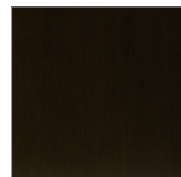

Wenge – M-WE

Natural Red Oak

Standard

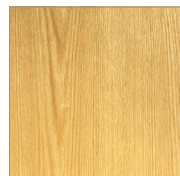

Natural Clear – O-NA

Red Oak Finishes

The following stains are available, add 10% to list

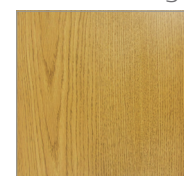

Castle Oak – O-CO



Honey Oak – O-HO

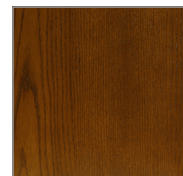

English Oak – O-EN



Victorian Cherry – O-VI

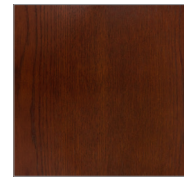

Richmond Cherry – O-RC

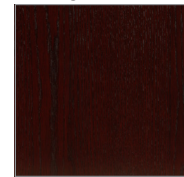

Mahogany – O-MA



Java – O-JA

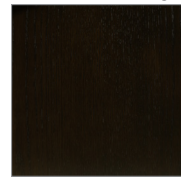

Wenge – O-WE

Natural Cherry

Add 20% to list



Natural Clear – C-NA

Cherry Finishes

The following stains are available, add 30% to list

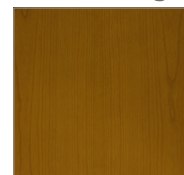

Honey Oak – C-HO

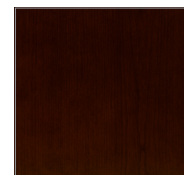

Richmond Cherry – C-RC

Natural Walnut

Add 20% to list



Natural Clear – W-NA

Walnut Finishes

The following stain is available, add 30% to list

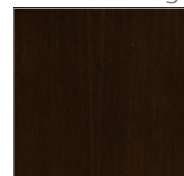

Java – W-JA

WILSONART® LAMINATES:

Solid, Abstract and Wood Grain Options



Frosty White
1573-60



Natural Almond
D30-60



Beige
1530-60



Fashion Grey
D381-60



Dove Grey
D92-60



Slate Grey
D91-60



Black
1595-60



Indigo
D379-60



Maroochy Brush
4745-60



Woolamai Brush
4746-60

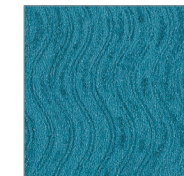

Blue Agave
4919-60



Eggplant
4913-60



Spiced Zephyr
4859-60



Morro Zephyr
4846-60



Fusion Maple
7909-60

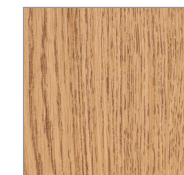

Bannister Oak
7806-60



Mambo
7948-60

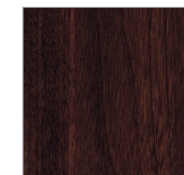

Cocobala
7942-38



Walnut Heights
7965-38



Wild Cherry
7054-60



Phantom Pearl
8211-38



White Driftwood
8200-38



Grey Elm
8201-38



Phantom Cocoa
8213-38



Studio Teak
7960-38



Skyline Walnut
7964-38



Phantom Charcoal
8214-38



Asian Night
7949-38

ABET LAMINATES:

Solid Colour Options

						
Bianco Ghiaccio 410	Beige 416	West Brown 892	Fondente 1828	Grigio Chiaro 478	Grigio Plomo 480	Grigio Scuro 871
						
Grigio Grafite 879	Nero 421	Giallo Pom Pom 463	Giallo Africa 469	Verde Erbetta 460	Sempreverde 451	Verde Biliardo 440
						
Verde Lauro 450	Verde Versailles 845	Bleu Panarea 482	Blu Amorgos 1824	Bleu California 499	Bleu Primario 838	Blu Cobalto 851
						
Blu Pavone 849	Blu Tenebre 1804	Blu Zaffiro 484	Blu Intenso 1818	Viola Madras 423	Viola Tramonto 424	Rosso Prugna 836
						
Rosso Antico 435	Rosso 431	Rosso Cavallino 1822	Arancio Canyon 835	Giallo Pop 861	Viola Sacro 1821	Fucsia 1840
						
Orchidea 1881	Viola Campanula 1827					

METAL PAINT:

Thermal Paint Colours

						
White PS-111-W374	Antique White W11	Telegrey 4 RAL 7047	Grey A16	Zinc A67	Charcoal A230	Black N49
						
Black Sandtex N31	Sparkle Silver S11	Champagne S14	Beige Gray RAL 7006	Zinc Yellow RAL 1018	Traffic Yellow RAL 1023	Deep Orange RAL 2011
						
Traffic Red RAL 3020	Carmine Red RAL 3002	Purple Red RAL 3004	Claret Violet RAL 4004	Signa Violet RAL 4008	Traffic Purple RAL 4006	Blue Lilac RAL 4005
						
Yellow Green RAL 6018	Signal Green RAL 6032	Turquoise Green RAL 6016	Light Blue RAL 5012	Sky Blue RAL 5015	Gentian Blue RAL 5010	Cobalt Blue RAL 5013

EDGE BAND COLOURS:

PVC edge band colour options



White
AC-SW811



Beige
AC-416



Fondente
AC-1828



Grigio Chiaro
AC-478



Grigio Plomo
AC-480



Zinc
AC-A67



Grigio Scuro
AC-871



Charcoal
AC-A230



Grigio Grafite
AC-879

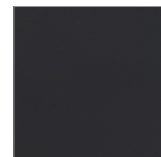

Black
AC-N49



Giallo Pom Pom
AC-463



Giallo Africa
AC-469



Verde Erbetta
AC-460



Sempreverde
AC-451



Verde Biliardo
AC-440



Verde Lauro
AC-450



Verde Versailles
AC-845



Bleu Panarea
AC-482



Blu Amorgos
AC-1824



Bleu California
AC-499



Bleu Primario
AC-838



Blu Pavone
AC-849



Blu Tenebre
AC-1804



Blu Zaffiro
AC-484



Blu Intenso
AC-1818



Viola Tramonto
AC-424



Rosso Prugna
AC-836



Rosso Antico
AC-435



Rosso
AC-431



Rosso Cavallino
AC-1822



Arancio Canyon
AC-835



Giallo Pop
AC-861



Fucsia
AC-1840



Orchidea
AC-1881



Hardrock Maple
AC-WM791



Natural Oak
AC-FWG9877

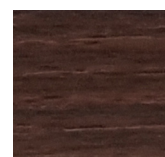

Chocolate Tick
AC-FWG7424



Silver
AC-FWG7424

HARDWOODS: All hardwood materials used in the manufacturing of Palmieri products shall be Northern grown hardwoods. Hardwoods will be air and kiln dried to a moisture content of 5-7%. All hardwoods shall be of grade "A" material, free of material stains, imperfections, conformity of grain, texture and color. Hardwood species shall be Northern grown Red Oak, Clear White Northern Maple and Birch. American Cherry and Honduras Mahogany and Walnut are available. Please inquire for pricing.

VENEER: Exposed face veneers shall be not less than 1/28" thick plain sliced veneers. Veneers are to be selected for conformity of grain direction and color. Veneers are to be stitched tightly in a book match, slip match or plain sliced configuration. Unexposed veneers are to be of hardwood but not selected for color, or grain quality. Veneers are not to be lap joined or reveal any tape or glue lines.

PARTICLE BOARD CORE: The particleboard shall be formed of wood chips, bonded with a water resistance adhesive. The particleboard material is to be of a high density 45 lbs/cu. ft. having a minimum average modulus of rupture of 2400 psi and a minimum average modulus of elasticity of 4,000,000 psi.

VENEER CORE: Veneer core is to be constructed with odd numbers of plies. Each ply is to be laminated in pairs and cross banded in opposite directions with grain direction at a 90 degree angle to the grain of the center core. All plies are to be free from knots, wrinkles, laps or other natural or manufacturing defects.

LUMBER CORE: Lumber core is to be of the highest quality grade. Grade "A" select stock. Lumber core shall be constructed of solid random width strips not less than 2" wide nor more than 3 1/2" wide by 1" thick. Wood strips will be free from knots or other defects. All strips will be tightly joined using water resistance adhesives.



HIGH PRESSURE LAMINATE: Work surface laminate shall be .050" thick and used with balancing backer sheet of no less than .028" thick. Laminate shall conform to standards set by the American Standards Institute/National Electrical Manufacturers Association (ANSI/NEMA) for thickness, performance and appearance. Printed colours, abstract patterns and wood grains are reproduced from representative segments of large sheets and may differ slightly from the actual product.







FINISHING PROCEDURES: All materials shall be inspected and treated with a final sanding and polishing operation before any staining and final finishing can be performed. All machine and mill marks are to be removed. Once the polishing and sanding has been performed, the furniture will then undergo the following stain and finishing procedures:

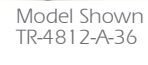





- Step 1 A base stain will be uniformly applied, wiped and then allowed to dry under factory controlled conditions.
- Step 2 A uniform coat of sealer will be applied and allowed to dry.
- Step 3 Sealer will be lightly sanded using 240 grit silicon paper.
- Step 4 A catalytic lacquer of 34-45 degree sheen is evenly applied and allowed to dry under factory controlled conditions.



METAL FINISHING PROCEDURES: All metal components are thoroughly cleaned and coated electrostatically with an epoxy powder coat paint finish. The metal components are then oven baked and cured for a lasting finish.







EDGE BANDS: All edge bands are manufactured in PVC, semi-rigid (Flex) and ABS. Standard edging size are normally 1.25" wide x 2 mm thick. These are made of the highest grade polymers and its materials are extensively tested prior to production using special test procedures and industry specification and quality standards.





MODEL NUMBER	PRODUCT	WIDTH	DEPTH	HEIGHT	SHELF DEPTH	# OF SHELVES	# OF OPENINGS	WEIGHT	VOLUME	LIST PRICE	DESCRIPTION
	TR-4210-S-24	Single Face Shelving	24 ¹³ / ₁₆ "	11 ⁹ / ₁₆ "	42"	9 ¹ / ₂ "	3			\$ 1,127	Made of a 1 ¹ / ₄ " x 2" metal frame with powder coat paint. METAL FINISHING: All metal components are thoroughly cleaned and coated electrostatically with an epoxy powder coat paint finish. The metal components are then oven baked and cured for a lasting finish.
	TR-4210-A-24	Single Face Adder	23 ⁹ / ₁₆ "	11 ⁹ / ₁₆ "	42"	9 ¹ / ₂ "	3			\$ 902	
	TR-4212-S-24	Single Face Shelving	24 ¹³ / ₁₆ "	13 ⁹ / ₁₆ "	42"	11 ¹ / ₂ "	3			\$ 1,158	
	TR-4212-A-24	Single Face Adder	23 ⁹ / ₁₆ "	13 ⁹ / ₁₆ "	42"	11 ¹ / ₂ "	3			\$ 925	
	TR-4214-S-24	Single Face Shelving	24 ¹³ / ₁₆ "	16 ¹ / ₁₆ "	42"	14"	3			\$ 1,182	
	TR-4214-A-24	Single Face Adder	23 ⁹ / ₁₆ "	16 ¹ / ₁₆ "	42"	14"	3			\$ 949	
	TR-4210-S-30	Single Face Shelving	30 ¹³ / ₁₆ "	11 ⁹ / ₁₆ "	42"	9 ¹ / ₂ "	3			\$ 1,127	
	TR-4210-A-30	Single Face Adder	29 ⁹ / ₁₆ "	11 ⁹ / ₁₆ "	42"	9 ¹ / ₂ "	3			\$ 902	
	TR-4212-S-30	Single Face Shelving	30 ¹³ / ₁₆ "	13 ⁹ / ₁₆ "	42"	11 ¹ / ₂ "	3			\$ 1,158	
	TR-4212-A-30	Single Face Adder	29 ⁹ / ₁₆ "	13 ⁹ / ₁₆ "	42"	11 ¹ / ₂ "	3			\$ 925	
	TR-4214-S-30	Single Face Shelving	30 ¹³ / ₁₆ "	16 ¹ / ₁₆ "	42"	14"	3			\$ 1,182	
	TR-4214-A-30	Single Face Adder	29 ⁹ / ₁₆ "	16 ¹ / ₁₆ "	42"	14"	3			\$ 949	
	TR-4210-S-36	Single Face Shelving	36 ¹³ / ₁₆ "	11 ⁹ / ₁₆ "	42"	9 ¹ / ₂ "	3	54 Lbs.		\$ 1,088	
	TR-4210-A-36	Single Face Adder	35 ⁹ / ₁₆ "	11 ⁹ / ₁₆ "	42"	9 ¹ / ₂ "	3	46 Lbs.		\$ 864	
	TR-4212-S-36	Single Face Shelving	36 ¹³ / ₁₆ "	13 ⁹ / ₁₆ "	42"	11 ¹ / ₂ "	3	55 Lbs.		\$ 1,119	
	TR-4212-A-36	Single Face Adder	35 ⁹ / ₁₆ "	13 ⁹ / ₁₆ "	42"	11 ¹ / ₂ "	3	47 Lbs.		\$ 877	
	TR-4214-S-36	Single Face Shelving	36 ¹³ / ₁₆ "	16 ¹ / ₁₆ "	42"	14"	3	58 Lbs.		\$ 1,143	
	TR-4214-A-36	Single Face Adder	35 ⁹ / ₁₆ "	16 ¹ / ₁₆ "	42"	14"	3	52 Lbs.		\$ 902	
	TR-4810-S-24	Single Face Shelving	24 ¹³ / ₁₆ "	11 ⁹ / ₁₆ "	48"	9 ¹ / ₂ "	3			\$ 1,158	
	TR-4810-A-24	Single Face Adder	23 ⁹ / ₁₆ "	11 ⁹ / ₁₆ "	48"	9 ¹ / ₂ "	3			\$ 925	
	TR-4812-S-24	Single Face Shelving	24 ¹³ / ₁₆ "	13 ⁹ / ₁₆ "	48"	11 ¹ / ₂ "	3			\$ 1,182	
	TR-4812-A-24	Single Face Adder	23 ⁹ / ₁₆ "	13 ⁹ / ₁₆ "	48"	11 ¹ / ₂ "	3			\$ 949	
	TR-4814-S-24	Single Face Shelving	24 ¹³ / ₁₆ "	16 ¹ / ₁₆ "	48"	14"	3			\$ 1,212	
	TR-4814-A-24	Single Face Adder	23 ⁹ / ₁₆ "	16 ¹ / ₁₆ "	48"	14"	3			\$ 971	
	TR-4810-S-30	Single Face Shelving	30 ¹³ / ₁₆ "	11 ⁹ / ₁₆ "	48"	9 ¹ / ₂ "	3			\$ 1,158	
	TR-4810-A-30	Single Face Adder	29 ⁹ / ₁₆ "	11 ⁹ / ₁₆ "	48"	9 ¹ / ₂ "	3			\$ 925	
	TR-4812-S-30	Single Face Shelving	30 ¹³ / ₁₆ "	13 ⁹ / ₁₆ "	48"	11 ¹ / ₂ "	3			\$ 1,182	
	TR-4812-A-30	Single Face Adder	29 ⁹ / ₁₆ "	13 ⁹ / ₁₆ "	48"	11 ¹ / ₂ "	3			\$ 949	
	TR-4814-S-30	Single Face Shelving	30 ¹³ / ₁₆ "	16 ¹ / ₁₆ "	48"	14"	3			\$ 1,212	
	TR-4814-A-30	Single Face Adder	29 ⁹ / ₁₆ "	16 ¹ / ₁₆ "	48"	14"	3			\$ 971	
	TR-4810-S-36	Single Face Shelving	36 ¹³ / ₁₆ "	11 ⁹ / ₁₆ "	48"	9 ¹ / ₂ "	3	55 Lbs.		\$ 1,119	
	TR-4810-A-36	Single Face Adder	35 ⁹ / ₁₆ "	11 ⁹ / ₁₆ "	48"	9 ¹ / ₂ "	3	47 Lbs.		\$ 895	
	TR-4812-S-36	Single Face Shelving	36 ¹³ / ₁₆ "	13 ⁹ / ₁₆ "	48"	11 ¹ / ₂ "	3	56 Lbs.		\$ 1,143	
	TR-4812-A-36	Single Face Adder	35 ⁹ / ₁₆ "	13 ⁹ / ₁₆ "	48"	11 ¹ / ₂ "	3	48 Lbs.		\$ 902	
	TR-4814-S-36	Single Face Shelving	36 ¹³ / ₁₆ "	16 ¹ / ₁₆ "	48"	14"	3	59 Lbs.		\$ 1,174	
	TR-4814-A-36	Single Face Adder	35 ⁹ / ₁₆ "	16 ¹ / ₁₆ "	48"	14"	3	53 Lbs.		\$ 925	

MODEL NUMBER	PRODUCT	WIDTH	DEPTH	HEIGHT	SHELF DEPTH	# OF SHELVES	# OF OPENINGS	WEIGHT	VOLUME	LIST PRICE	DESCRIPTION
 Model Shown TR-6612-S-36	TR-6610-S-24	Single Face Shelving	24 ^{13/16"}	11 ^{9/16"}	66"	9 ^{1/2"}	4			\$ 1,375	Made of a 1 ^{1/4"} x 2" metal frame with powder coat paint. METAL FINISHING: All metal components are thoroughly cleaned and coated electrostatically with an epoxy powder coat paint finish. The metal components are then oven baked and cured for a lasting finish.
	TR-6610-A-24	Single Face Adder	23 ^{9/16"}	11 ^{9/16"}	66"	9 ^{1/2"}	4			\$ 1,112	
	TR-6612-S-24	Single Face Shelving	24 ^{13/16"}	13 ^{9/16"}	66"	11 ^{1/2"}	4			\$ 1,406	
	TR-6612-A-24	Single Face Adder	23 ^{9/16"}	13 ^{9/16"}	66"	11 ^{1/2"}	4			\$ 1,143	
	TR-6614-S-24	Single Face Shelving	24 ^{13/16"}	16 ^{1/16"}	66"	14"	4			\$ 1,439	
	TR-6614-A-24	Single Face Adder	23 ^{9/16"}	16 ^{1/16"}	66"	14"	4			\$ 1,174	
 Model Shown TR-6612-A-36	TR-6610-S-30	Single Face Shelving	30 ^{13/16"}	11 ^{9/16"}	66"	9 ^{1/2"}	4			\$ 1,375	
	TR-6610-A-30	Single Face Adder	29 ^{9/16"}	11 ^{9/16"}	66"	9 ^{1/2"}	4			\$ 1,112	
	TR-6612-S-30	Single Face Shelving	30 ^{13/16"}	13 ^{9/16"}	66"	11 ^{1/2"}	4			\$ 1,406	
	TR-6612-A-30	Single Face Adder	29 ^{9/16"}	13 ^{9/16"}	66"	11 ^{1/2"}	4			\$ 1,143	
	TR-6614-S-30	Single Face Shelving	30 ^{13/16"}	16 ^{1/16"}	66"	14"	4			\$ 1,439	
	TR-6614-A-30	Single Face Adder	29 ^{9/16"}	16 ^{1/16"}	66"	14"	4			\$ 1,174	
 Model Shown TR-7812-S-36	TR-6610-S-36	Single Face Shelving	36 ^{13/16"}	11 ^{9/16"}	66"	9 ^{1/2"}	4	69 Lbs.		\$ 1,323	
	TR-6610-A-36	Single Face Adder	35 ^{9/16"}	11 ^{9/16"}	66"	9 ^{1/2"}	4	57 Lbs.		\$ 1,058	
	TR-6612-S-36	Single Face Shelving	36 ^{13/16"}	13 ^{9/16"}	66"	11 ^{1/2"}	4	70 Lbs.		\$ 1,360	
	TR-6612-A-36	Single Face Adder	35 ^{9/16"}	13 ^{9/16"}	66"	11 ^{1/2"}	4	59 Lbs.		\$ 1,081	
	TR-6614-S-36	Single Face Shelving	36 ^{13/16"}	16 ^{1/16"}	66"	14"	4	77 Lbs.		\$ 1,383	
	TR-6614-A-36	Single Face Adder	35 ^{9/16"}	16 ^{1/16"}	66"	14"	4	65 Lbs.		\$ 1,105	
 Model Shown TR-7812-A-36	TR-7810-S-24	Single Face Shelving	24 ^{13/16"}	11 ^{9/16"}	78"	9 ^{1/2"}	5			\$ 1,593	
	TR-7810-A-24	Single Face Adder	23 ^{9/16"}	11 ^{9/16"}	78"	9 ^{1/2"}	5			\$ 1,306	
	TR-7812-S-24	Single Face Shelving	24 ^{13/16"}	13 ^{9/16"}	78"	11 ^{1/2"}	5			\$ 1,633	
	TR-7812-A-24	Single Face Adder	23 ^{9/16"}	13 ^{9/16"}	78"	11 ^{1/2"}	5			\$ 1,344	
	TR-7814-S-24	Single Face Shelving	24 ^{13/16"}	16 ^{1/16"}	78"	14"	5			\$ 1,671	
	TR-7814-A-24	Single Face Adder	23 ^{9/16"}	16 ^{1/16"}	78"	14"	5			\$ 1,383	
 Model Shown TR-7812-S-36	TR-7810-S-30	Single Face Shelving	30 ^{13/16"}	11 ^{9/16"}	78"	9 ^{1/2"}	5			\$ 1,593	
	TR-7810-A-30	Single Face Adder	29 ^{9/16"}	11 ^{9/16"}	78"	9 ^{1/2"}	5			\$ 1,306	
	TR-7812-S-30	Single Face Shelving	30 ^{13/16"}	13 ^{9/16"}	78"	11 ^{1/2"}	5			\$ 1,633	
	TR-7812-A-30	Single Face Adder	29 ^{9/16"}	13 ^{9/16"}	78"	11 ^{1/2"}	5			\$ 1,344	
	TR-7814-S-30	Single Face Shelving	30 ^{13/16"}	16 ^{1/16"}	78"	14"	5			\$ 1,671	
	TR-7814-A-30	Single Face Adder	29 ^{9/16"}	16 ^{1/16"}	78"	14"	5			\$ 1,383	
 Model Shown TR-7812-A-36	TR-7810-S-36	Single Face Shelving	36 ^{13/16"}	11 ^{9/16"}	78"	9 ^{1/2"}	5	80 Lbs.		\$ 1,531	
	TR-7810-A-36	Single Face Adder	35 ^{9/16"}	11 ^{9/16"}	78"	9 ^{1/2"}	5	67 Lbs.		\$ 1,236	
	TR-7812-S-36	Single Face Shelving	36 ^{13/16"}	13 ^{9/16"}	78"	11 ^{1/2"}	5	83 Lbs.		\$ 1,563	
	TR-7812-A-36	Single Face Adder	35 ^{9/16"}	13 ^{9/16"}	78"	11 ^{1/2"}	5	70 Lbs.		\$ 1,268	
	TR-7814-S-36	Single Face Shelving	36 ^{13/16"}	16 ^{1/16"}	78"	14"	5	92 Lbs.		\$ 1,610	
	TR-7814-A-36	Single Face Adder	35 ^{9/16"}	16 ^{1/16"}	78"	14"	5	77 Lbs.		\$ 1,298	

MODEL NUMBER	PRODUCT	WIDTH	DEPTH	HEIGHT	SHELF DEPTH	# OF SHELVES	# OF OPENINGS	WEIGHT	VOLUME	LIST PRICE	DESCRIPTION
 Model Shown TR-8412-S-36	TR-8410-S-24	Single Face Shelving	24 ^{13/16} "	11 ^{9/16} "	84"	9 ^{1/2} "	6			\$ 1,827	Made of a 1 ^{1/4} " x 2" metal frame with powder coat paint. METAL FINISHING: All metal components are thoroughly cleaned and coated electrostatically with an epoxy powder coat paint finish. The metal components are then oven baked and cured for a lasting finish.
	TR-8410-A-24	Single Face Adder	23 ^{9/16} "	11 ^{9/16} "	84"	9 ^{1/2} "	6			\$ 1,508	
	TR-8412-S-24	Single Face Shelving	24 ^{13/16} "	13 ^{9/16} "	84"	11 ^{1/2} "	6			\$ 1,881	
	TR-8412-A-24	Single Face Adder	23 ^{9/16} "	13 ^{9/16} "	84"	11 ^{1/2} "	6			\$ 1,555	
	TR-8414-S-24	Single Face Shelving	24 ^{13/16} "	16 ^{1/16} "	84"	14"	6			\$ 1,929	
	TR-8414-A-24	Single Face Adder	23 ^{9/16} "	16 ^{1/16} "	84"	14"	6			\$ 1,593	
 Model Shown TR-8412-A-36	TR-8410-S-30	Single Face Shelving	30 ^{13/16} "	11 ^{9/16} "	84"	9 ^{1/2} "	6			\$ 1,827	
	TR-8410-A-30	Single Face Adder	29 ^{9/16} "	11 ^{9/16} "	84"	9 ^{1/2} "	6			\$ 1,508	
	TR-8412-S-30	Single Face Shelving	30 ^{13/16} "	13 ^{9/16} "	84"	11 ^{1/2} "	6			\$ 1,881	
	TR-8412-A-30	Single Face Adder	29 ^{9/16} "	13 ^{9/16} "	84"	11 ^{1/2} "	6			\$ 1,555	
	TR-8414-S-30	Single Face Shelving	30 ^{13/16} "	16 ^{1/16} "	84"	14"	6			\$ 1,929	
	TR-8414-A-30	Single Face Adder	29 ^{9/16} "	16 ^{1/16} "	84"	14"	6			\$ 1,593	
 Model Shown TR-9012-A-36	TR-8410-S-36	Single Face Shelving	36 ^{13/16} "	11 ^{9/16} "	84"	9 ^{1/2} "	6	98 Lbs.		\$ 1,748	
	TR-8410-A-36	Single Face Adder	35 ^{9/16} "	11 ^{9/16} "	84"	9 ^{1/2} "	6	84 Lbs.		\$ 1,431	
	TR-8412-S-36	Single Face Shelving	36 ^{13/16} "	13 ^{9/16} "	84"	11 ^{1/2} "	6	102 Lbs.		\$ 1,795	
	TR-8412-A-36	Single Face Adder	35 ^{9/16} "	13 ^{9/16} "	84"	11 ^{1/2} "	6	88 Lbs.		\$ 1,469	
	TR-8414-S-36	Single Face Shelving	36 ^{13/16} "	16 ^{1/16} "	84"	14"	6	114 Lbs.		\$ 1,841	
	TR-8414-A-36	Single Face Adder	35 ^{9/16} "	16 ^{1/16} "	84"	14"	6	99 Lbs.		\$ 1,500	
 Model Shown TR-9012-S-36	TR-9010-S-24	Single Face Shelving	24 ^{13/16} "	11 ^{9/16} "	90"	9 ^{1/2} "	7			\$ 2,083	
	TR-9010-A-24	Single Face Adder	23 ^{9/16} "	11 ^{9/16} "	90"	9 ^{1/2} "	7			\$ 1,727	
	TR-9012-S-24	Single Face Shelving	24 ^{13/16} "	13 ^{9/16} "	90"	11 ^{1/2} "	7			\$ 2,139	
	TR-9012-A-24	Single Face Adder	23 ^{9/16} "	13 ^{9/16} "	90"	11 ^{1/2} "	7			\$ 1,772	
	TR-9014-S-24	Single Face Shelving	24 ^{13/16} "	16 ^{1/16} "	90"	14"	7			\$ 2,200	
	TR-9014-A-24	Single Face Adder	23 ^{9/16} "	16 ^{1/16} "	90"	14"	7			\$ 1,827	
 Model Shown TR-9012-A-36	TR-9010-S-30	Single Face Shelving	30 ^{13/16} "	11 ^{9/16} "	90"	9 ^{1/2} "	7			\$ 2,083	
	TR-9010-A-30	Single Face Adder	29 ^{9/16} "	11 ^{9/16} "	90"	9 ^{1/2} "	7			\$ 1,727	
	TR-9012-S-30	Single Face Shelving	30 ^{13/16} "	13 ^{9/16} "	90"	11 ^{1/2} "	7			\$ 2,139	
	TR-9012-A-30	Single Face Adder	29 ^{9/16} "	13 ^{9/16} "	90"	11 ^{1/2} "	7			\$ 1,772	
	TR-9014-S-30	Single Face Shelving	30 ^{13/16} "	16 ^{1/16} "	90"	14"	7			\$ 2,200	
	TR-9014-A-30	Single Face Adder	29 ^{9/16} "	16 ^{1/16} "	90"	14"	7			\$ 1,827	
 Model Shown TR-9012-A-36	TR-9010-S-36	Single Face Shelving	36 ^{13/16} "	11 ^{9/16} "	90"	9 ^{1/2} "	7	103 Lbs.		\$ 1,998	
	TR-9010-A-36	Single Face Adder	35 ^{9/16} "	11 ^{9/16} "	90"	9 ^{1/2} "	7	85 Lbs.		\$ 1,633	
	TR-9012-S-36	Single Face Shelving	36 ^{13/16} "	13 ^{9/16} "	90"	11 ^{1/2} "	7	104 Lbs.		\$ 2,053	
	TR-9012-A-36	Single Face Adder	35 ^{9/16} "	13 ^{9/16} "	90"	11 ^{1/2} "	7	89 Lbs.		\$ 1,671	
	TR-9014-S-36	Single Face Shelving	36 ^{13/16} "	16 ^{1/16} "	90"	14"	7	116 Lbs.		\$ 2,122	
	TR-9014-A-36	Single Face Adder	35 ^{9/16} "	16 ^{1/16} "	90"	14"	7	100 Lbs.		\$ 1,727	

	MODEL NUMBER	PRODUCT	WIDTH	DEPTH	HEIGHT	SHELF DEPTH	# OF SHELVES	# OF OPENINGS	WEIGHT	VOLUME	LIST PRICE	DESCRIPTION
	TR-4220-S-24	Double Face Shelving	24 ¹³ / ₁₆ "	21 ¹ / ₈ "	42"	9 ¹ / ₂ "	6	6			\$ 1,734	Made of a 1 ¹ / ₄ " x 2" metal frame with powder coat paint. METAL FINISHING: All metal components are thoroughly cleaned and coated electrostatically with an epoxy powder coat paint finish. The metal components are then oven baked and cured for a lasting finish.
	TR-4220-A-24	Double Face Adder	23 ⁹ / ₁₆ "	21 ¹ / ₈ "	42"	9 ¹ / ₂ "	6	6			\$ 1,462	
	TR-4224-S-24	Double Face Shelving	24 ¹³ / ₁₆ "	25 ¹ / ₈ "	42"	11 ¹ / ₂ "	6	6			\$ 1,780	
	TR-4224-A-24	Double Face Adder	23 ⁹ / ₁₆ "	25 ¹ / ₈ "	42"	11 ¹ / ₂ "	6	6			\$ 1,500	
	TR-4228-S-24	Double Face Shelving	24 ¹³ / ₁₆ "	30 ¹ / ₈ "	42"	14"	6	6			\$ 1,827	
	TR-4228-A-24	Double Face Adder	23 ⁹ / ₁₆ "	30 ¹ / ₈ "	42"	14"	6	6			\$ 1,547	
Model Shown TR-4824-S-36 	TR-4220-S-30	Double Face Shelving	30 ¹³ / ₁₆ "	21 ¹ / ₈ "	42"	9 ¹ / ₂ "	6	6			\$ 1,734	
	TR-4220-A-30	Double Face Adder	29 ⁹ / ₁₆ "	21 ¹ / ₈ "	42"	9 ¹ / ₂ "	6	6			\$ 1,462	
	TR-4224-S-30	Double Face Shelving	30 ¹³ / ₁₆ "	25 ¹ / ₈ "	42"	11 ¹ / ₂ "	6	6			\$ 1,780	
	TR-4224-A-30	Double Face Adder	29 ⁹ / ₁₆ "	25 ¹ / ₈ "	42"	11 ¹ / ₂ "	6	6			\$ 1,500	
	TR-4228-S-30	Double Face Shelving	30 ¹³ / ₁₆ "	30 ¹ / ₈ "	42"	14"	6	6			\$ 1,827	
	TR-4228-A-30	Double Face Adder	29 ⁹ / ₁₆ "	30 ¹ / ₈ "	42"	14"	6	6			\$ 1,547	
Model Shown TR-4824-A-36 	TR-4220-S-36	Double Face Shelving	36 ¹³ / ₁₆ "	21 ¹ / ₈ "	42"	9 ¹ / ₂ "	6	6	82 Lbs.		\$ 1,656	
	TR-4220-A-36	Double Face Adder	35 ⁹ / ₁₆ "	21 ¹ / ₈ "	42"	9 ¹ / ₂ "	6	6	73 Lbs.		\$ 1,383	
	TR-4224-S-36	Double Face Shelving	36 ¹³ / ₁₆ "	25 ¹ / ₈ "	42"	11 ¹ / ₂ "	6	6	86 Lbs.		\$ 1,703	
	TR-4224-A-36	Double Face Adder	35 ⁹ / ₁₆ "	25 ¹ / ₈ "	42"	11 ¹ / ₂ "	6	6	76 Lbs.		\$ 1,423	
	TR-4228-S-36	Double Face Shelving	36 ¹³ / ₁₆ "	30 ¹ / ₈ "	42"	14"	6	6	96 Lbs.		\$ 1,748	
	TR-4228-A-36	Double Face Adder	35 ⁹ / ₁₆ "	30 ¹ / ₈ "	42"	14"	6	6	86 Lbs.		\$ 1,462	
	TR-4820-S-24	Double Face Shelving	24 ¹³ / ₁₆ "	21 ¹ / ₈ "	48"	9 ¹ / ₂ "	6	6			\$ 1,780	
	TR-4820-A-24	Double Face Adder	23 ⁹ / ₁₆ "	21 ¹ / ₈ "	48"	9 ¹ / ₂ "	6	6			\$ 1,500	
	TR-4824-S-24	Double Face Shelving	24 ¹³ / ₁₆ "	25 ¹ / ₈ "	48"	11 ¹ / ₂ "	6	6			\$ 1,827	
	TR-4824-A-24	Double Face Adder	23 ⁹ / ₁₆ "	25 ¹ / ₈ "	48"	11 ¹ / ₂ "	6	6			\$ 1,547	
	TR-4828-S-24	Double Face Shelving	24 ¹³ / ₁₆ "	30 ¹ / ₈ "	48"	14"	6	6			\$ 1,881	
	TR-4828-A-24	Double Face Adder	23 ⁹ / ₁₆ "	30 ¹ / ₈ "	48"	14"	6	6			\$ 1,593	
	TR-4820-S-30	Double Face Shelving	30 ¹³ / ₁₆ "	21 ¹ / ₈ "	48"	9 ¹ / ₂ "	6	6			\$ 1,780	
	TR-4820-A-30	Double Face Adder	29 ⁹ / ₁₆ "	21 ¹ / ₈ "	48"	9 ¹ / ₂ "	6	6			\$ 1,500	
	TR-4824-S-30	Double Face Shelving	30 ¹³ / ₁₆ "	25 ¹ / ₈ "	48"	11 ¹ / ₂ "	6	6			\$ 1,827	
	TR-4824-A-30	Double Face Adder	29 ⁹ / ₁₆ "	25 ¹ / ₈ "	48"	11 ¹ / ₂ "	6	6			\$ 1,547	
	TR-4828-S-30	Double Face Shelving	30 ¹³ / ₁₆ "	30 ¹ / ₈ "	48"	14"	6	6			\$ 1,881	
	TR-4828-A-30	Double Face Adder	29 ⁹ / ₁₆ "	30 ¹ / ₈ "	48"	14"	6	6			\$ 1,593	
	TR-4820-S-36	Double Face Shelving	36 ¹³ / ₁₆ "	21 ¹ / ₈ "	48"	9 ¹ / ₂ "	6	6	84 Lbs.		\$ 1,703	
	TR-4820-A-36	Double Face Adder	35 ⁹ / ₁₆ "	21 ¹ / ₈ "	48"	9 ¹ / ₂ "	6	6	75 Lbs.		\$ 1,423	
	TR-4824-S-36	Double Face Shelving	36 ¹³ / ₁₆ "	25 ¹ / ₈ "	48"	11 ¹ / ₂ "	6	6	88 Lbs.		\$ 1,748	
	TR-4824-A-36	Double Face Adder	35 ⁹ / ₁₆ "	25 ¹ / ₈ "	48"	11 ¹ / ₂ "	6	6	78 Lbs.		\$ 1,469	
	TR-4828-S-36	Double Face Shelving	36 ¹³ / ₁₆ "	30 ¹ / ₈ "	48"	14"	6	6	98 Lbs.		\$ 1,804	
	TR-4828-A-36	Double Face Adder	35 ⁹ / ₁₆ "	30 ¹ / ₈ "	48"	14"	6	6	88 Lbs.		\$ 1,500	

MODEL NUMBER	PRODUCT	WIDTH	DEPTH	HEIGHT	SHELF DEPTH	# OF SHELVES	# OF OPENINGS	WEIGHT	VOLUME	LIST PRICE	DESCRIPTION
 Model Shown TR-6624-S-36	TR-6620-S-24	Double Face Shelving	24 ¹³ / ₁₆ "	21 ¹ / ₈ "	66"	9 ¹ / ₂ "	8			\$ 2,146	Made of a 1 ¹ / ₄ " x 2" metal frame with powder coat paint. METAL FINISHING: All metal components are thoroughly cleaned and coated electrostatically with an epoxy powder coat paint finish. The metal components are then oven baked and cured for a lasting finish.
	TR-6620-A-24	Double Face Adder	23 ⁹ / ₁₆ "	21 ¹ / ₈ "	66"	9 ¹ / ₂ "	8			\$ 1,834	
	TR-6624-S-24	Double Face Shelving	24 ¹³ / ₁₆ "	25 ¹ / ₈ "	66"	11 ¹ / ₂ "	8			\$ 2,200	
	TR-6624-A-24	Double Face Adder	23 ⁹ / ₁₆ "	25 ¹ / ₈ "	66"	11 ¹ / ₂ "	8			\$ 1,889	
	TR-6628-S-24	Double Face Shelving	24 ¹³ / ₁₆ "	30 ¹ / ₈ "	66"	14"	8			\$ 2,263	
	TR-6628-A-24	Double Face Adder	23 ⁹ / ₁₆ "	30 ¹ / ₈ "	66"	14"	8			\$ 1,935	
 Model Shown TR-6624-A-36	TR-6620-S-30	Double Face Shelving	30 ¹³ / ₁₆ "	21 ¹ / ₈ "	66"	9 ¹ / ₂ "	8			\$ 2,146	
	TR-6620-A-30	Double Face Adder	29 ⁹ / ₁₆ "	21 ¹ / ₈ "	66"	9 ¹ / ₂ "	8			\$ 1,834	
	TR-6624-S-30	Double Face Shelving	30 ¹³ / ₁₆ "	25 ¹ / ₈ "	66"	11 ¹ / ₂ "	8			\$ 2,200	
	TR-6624-A-30	Double Face Adder	29 ⁹ / ₁₆ "	25 ¹ / ₈ "	66"	11 ¹ / ₂ "	8			\$ 1,889	
	TR-6628-S-30	Double Face Shelving	30 ¹³ / ₁₆ "	30 ¹ / ₈ "	66"	14"	8			\$ 2,263	
	TR-6628-A-30	Double Face Adder	29 ⁹ / ₁₆ "	30 ¹ / ₈ "	66"	14"	8			\$ 1,935	
 Model Shown TR-7824-S-36	TR-6620-S-36	Double Face Shelving	36 ¹³ / ₁₆ "	21 ¹ / ₈ "	66"	9 ¹ / ₂ "	8	106 Lbs.		\$ 2,045	
	TR-6620-A-36	Double Face Adder	35 ⁹ / ₁₆ "	21 ¹ / ₈ "	66"	9 ¹ / ₂ "	8	93 Lbs.		\$ 1,734	
	TR-6624-S-36	Double Face Shelving	36 ¹³ / ₁₆ "	25 ¹ / ₈ "	66"	11 ¹ / ₂ "	8	111 Lbs.		\$ 2,100	
	TR-6624-A-36	Double Face Adder	35 ⁹ / ₁₆ "	25 ¹ / ₈ "	66"	11 ¹ / ₂ "	8	97 Lbs.		\$ 1,788	
	TR-6628-S-36	Double Face Shelving	36 ¹³ / ₁₆ "	30 ¹ / ₈ "	66"	14"	8	124 Lbs.		\$ 2,162	
	TR-6628-A-36	Double Face Adder	35 ⁹ / ₁₆ "	30 ¹ / ₈ "	66"	14"	8	110 Lbs.		\$ 1,834	
 Model Shown TR-7824-A-36	TR-7820-S-24	Double Face Shelving	24 ¹³ / ₁₆ "	21 ¹ / ₈ "	78"	9 ¹ / ₂ "	10			\$ 2,566	
	TR-7820-A-24	Double Face Adder	23 ⁹ / ₁₆ "	21 ¹ / ₈ "	78"	9 ¹ / ₂ "	10			\$ 2,224	
	TR-7824-S-24	Double Face Shelving	24 ¹³ / ₁₆ "	25 ¹ / ₈ "	78"	11 ¹ / ₂ "	10			\$ 2,643	
	TR-7824-A-24	Double Face Adder	23 ⁹ / ₁₆ "	25 ¹ / ₈ "	78"	11 ¹ / ₂ "	10			\$ 2,286	
	TR-7828-S-24	Double Face Shelving	24 ¹³ / ₁₆ "	30 ¹ / ₈ "	78"	14"	10			\$ 2,712	
	TR-7828-A-24	Double Face Adder	23 ⁹ / ₁₆ "	30 ¹ / ₈ "	78"	14"	10			\$ 2,356	
 Model Shown TR-7824-S-36	TR-7820-S-30	Double Face Shelving	30 ¹³ / ₁₆ "	21 ¹ / ₈ "	78"	9 ¹ / ₂ "	10			\$ 2,566	
	TR-7820-A-30	Double Face Adder	29 ⁹ / ₁₆ "	21 ¹ / ₈ "	78"	9 ¹ / ₂ "	10			\$ 2,224	
	TR-7824-S-30	Double Face Shelving	30 ¹³ / ₁₆ "	25 ¹ / ₈ "	78"	11 ¹ / ₂ "	10			\$ 2,643	
	TR-7824-A-30	Double Face Adder	29 ⁹ / ₁₆ "	25 ¹ / ₈ "	78"	11 ¹ / ₂ "	10			\$ 2,286	
	TR-7828-S-30	Double Face Shelving	30 ¹³ / ₁₆ "	30 ¹ / ₈ "	78"	14"	10			\$ 2,712	
	TR-7828-A-30	Double Face Adder	29 ⁹ / ₁₆ "	30 ¹ / ₈ "	78"	14"	10			\$ 2,356	
 Model Shown TR-7824-A-36	TR-7820-S-36	Double Face Shelving	36 ¹³ / ₁₆ "	21 ¹ / ₈ "	78"	9 ¹ / ₂ "	10	125 Lbs.		\$ 2,448	
	TR-7820-A-36	Double Face Adder	35 ⁹ / ₁₆ "	21 ¹ / ₈ "	78"	9 ¹ / ₂ "	10	110 Lbs.		\$ 2,100	
	TR-7824-S-36	Double Face Shelving	36 ¹³ / ₁₆ "	25 ¹ / ₈ "	78"	11 ¹ / ₂ "	10	131 Lbs.		\$ 2,519	
	TR-7824-A-36	Double Face Adder	35 ⁹ / ₁₆ "	25 ¹ / ₈ "	78"	11 ¹ / ₂ "	10	116 Lbs.		\$ 2,162	
	TR-7828-S-36	Double Face Shelving	36 ¹³ / ₁₆ "	30 ¹ / ₈ "	78"	14"	10	147 Lbs.		\$ 2,588	
	TR-7828-A-36	Double Face Adder	35 ⁹ / ₁₆ "	30 ¹ / ₈ "	78"	14"	10	131 Lbs.		\$ 2,224	

MODEL NUMBER	PRODUCT	WIDTH	DEPTH	HEIGHT	SHELF DEPTH	# OF SHELVES	# OF OPENINGS	WEIGHT	VOLUME	LIST PRICE	DESCRIPTION
 Model Shown TR-8420-S-36	TR-8420-S-24	Double Face Shelving	24 ¹³ / ₁₆ "	21 ¹ / ₈ "	84"	9 ¹ / ₂ "	12			\$ 2,977	Made of a 1 ¹ / ₄ " x 2" metal frame with powder coat paint. METAL FINISHING: All metal components are thoroughly cleaned and coated electrostatically with an epoxy powder coat paint finish. The metal components are then oven baked and cured for a lasting finish.
	TR-8420-A-24	Double Face Adder	23 ⁹ / ₁₆ "	21 ¹ / ₈ "	84"	9 ¹ / ₂ "	12			\$ 2,588	
	TR-8424-S-24	Double Face Shelving	24 ¹³ / ₁₆ "	25 ¹ / ₈ "	84"	11 ¹ / ₂ "	12			\$ 3,056	
	TR-8424-A-24	Double Face Adder	23 ⁹ / ₁₆ "	25 ¹ / ₈ "	84"	11 ¹ / ₂ "	12			\$ 2,666	
	TR-8428-S-24	Double Face Shelving	24 ¹³ / ₁₆ "	30 ¹ / ₈ "	84"	14"	12			\$ 3,148	
	TR-8428-A-24	Double Face Adder	23 ⁹ / ₁₆ "	30 ¹ / ₈ "	84"	14"	12			\$ 2,744	
 Model Shown TR-8424-A-36	TR-8420-S-30	Double Face Shelving	30 ¹³ / ₁₆ "	21 ¹ / ₈ "	84"	9 ¹ / ₂ "	12			\$ 2,977	
	TR-8420-A-30	Double Face Adder	29 ⁹ / ₁₆ "	21 ¹ / ₈ "	84"	9 ¹ / ₂ "	12			\$ 2,588	
	TR-8424-S-30	Double Face Shelving	30 ¹³ / ₁₆ "	25 ¹ / ₈ "	84"	11 ¹ / ₂ "	12			\$ 3,056	
	TR-8424-A-30	Double Face Adder	29 ⁹ / ₁₆ "	25 ¹ / ₈ "	84"	11 ¹ / ₂ "	12			\$ 2,666	
	TR-8428-S-30	Double Face Shelving	30 ¹³ / ₁₆ "	30 ¹ / ₈ "	84"	14"	12			\$ 3,148	
	TR-8428-A-30	Double Face Adder	29 ⁹ / ₁₆ "	30 ¹ / ₈ "	84"	14"	12			\$ 2,744	
 Model Shown TR-9024-S-36	TR-8420-S-36	Double Face Shelving	36 ¹³ / ₁₆ "	21 ¹ / ₈ "	84"	9 ¹ / ₂ "	12	160 Lbs.		\$ 2,829	
	TR-8420-A-36	Double Face Adder	35 ⁹ / ₁₆ "	21 ¹ / ₈ "	84"	9 ¹ / ₂ "	12	144 Lbs.		\$ 2,448	
	TR-8424-S-36	Double Face Shelving	36 ¹³ / ₁₆ "	25 ¹ / ₈ "	84"	11 ¹ / ₂ "	12	167 Lbs.		\$ 2,915	
	TR-8424-A-36	Double Face Adder	35 ⁹ / ₁₆ "	25 ¹ / ₈ "	84"	11 ¹ / ₂ "	12	151 Lbs.		\$ 2,519	
	TR-8428-S-36	Double Face Shelving	36 ¹³ / ₁₆ "	30 ¹ / ₈ "	84"	14"	12	189 Lbs.		\$ 3,000	
	TR-8428-A-36	Double Face Adder	35 ⁹ / ₁₆ "	30 ¹ / ₈ "	84"	14"	12	172 Lbs.		\$ 2,588	
 Model Shown TR-9024-A-36	TR-9020-S-24	Double Face Shelving	24 ¹³ / ₁₆ "	21 ¹ / ₈ "	90"	9 ¹ / ₂ "	14			\$ 3,397	
	TR-9020-A-24	Double Face Adder	23 ⁹ / ₁₆ "	21 ¹ / ₈ "	90"	9 ¹ / ₂ "	14			\$ 2,977	
	TR-9024-S-24	Double Face Shelving	24 ¹³ / ₁₆ "	25 ¹ / ₈ "	90"	11 ¹ / ₂ "	14			\$ 3,498	
	TR-9024-A-24	Double Face Adder	23 ⁹ / ₁₆ "	25 ¹ / ₈ "	90"	11 ¹ / ₂ "	14			\$ 3,056	
	TR-9028-S-24	Double Face Shelving	24 ¹³ / ₁₆ "	30 ¹ / ₈ "	90"	14"	14			\$ 3,599	
	TR-9028-A-24	Double Face Adder	23 ⁹ / ₁₆ "	30 ¹ / ₈ "	90"	14"	14			\$ 3,148	
	TR-9020-S-30	Double Face Shelving	30 ¹³ / ₁₆ "	21 ¹ / ₈ "	90"	9 ¹ / ₂ "	14			\$ 3,397	
	TR-9020-A-30	Double Face Adder	29 ⁹ / ₁₆ "	21 ¹ / ₈ "	90"	9 ¹ / ₂ "	14			\$ 2,977	
	TR-9024-S-30	Double Face Shelving	30 ¹³ / ₁₆ "	25 ¹ / ₈ "	90"	11 ¹ / ₂ "	14			\$ 3,498	
	TR-9024-A-30	Double Face Adder	29 ⁹ / ₁₆ "	25 ¹ / ₈ "	90"	11 ¹ / ₂ "	14			\$ 3,056	
	TR-9028-S-30	Double Face Shelving	30 ¹³ / ₁₆ "	30 ¹ / ₈ "	90"	14"	14			\$ 3,599	
	TR-9028-A-30	Double Face Adder	29 ⁹ / ₁₆ "	30 ¹ / ₈ "	90"	14"	14			\$ 3,148	
	TR-9020-S-36	Double Face Shelving	36 ¹³ / ₁₆ "	21 ¹ / ₈ "	90"	9 ¹ / ₂ "	14	161 Lbs.		\$ 3,241	
	TR-9020-A-36	Double Face Adder	35 ⁹ / ₁₆ "	21 ¹ / ₈ "	90"	9 ¹ / ₂ "	14	144 Lbs.		\$ 2,815	
TR-9024-S-36	Double Face Shelving	36 ¹³ / ₁₆ "	25 ¹ / ₈ "	90"	11 ¹ / ₂ "	14	169 Lbs.		\$ 3,327		
TR-9024-A-36	Double Face Adder	35 ⁹ / ₁₆ "	25 ¹ / ₈ "	90"	11 ¹ / ₂ "	14	152 Lbs.		\$ 2,899		
TR-9028-S-36	Double Face Shelving	36 ¹³ / ₁₆ "	30 ¹ / ₈ "	90"	14"	14	191 Lbs.		\$ 3,428		
TR-9028-A-36	Double Face Adder	35 ⁹ / ₁₆ "	30 ¹ / ₈ "	90"	14"	14	173 Lbs.		\$ 2,985		

MODEL NUMBER	PRODUCT	WIDTH	DEPTH	HEIGHT	SHELF DEPTH	# OF SHELVES	# OF OPENINGS	WEIGHT	VOLUME	LIST PRICE	DESCRIPTION
TR-4212-S-M-24	Single Face Shelving	24 ¹³ / ₁₆ "	13 ⁹ / ₁₆ "	42"	11 ¹ / ₂ "	2	2	65 Lbs.		\$ 1,383	Made of a 1 ¹ / ₄ " x 2" metal frame with powder coat paint.
TR-4212-A-M-24	Single Face Adder	23 ⁹ / ₁₆ "	13 ⁹ / ₁₆ "	42"	11 ¹ / ₂ "	2	2	57 Lbs.		\$ 1,135	
TR-4212-S-M-30	Single Face Shelving	30 ¹³ / ₁₆ "	13 ⁹ / ₁₆ "	42"	11 ¹ / ₂ "	2	2			\$ 1,383	METAL FINISHING: All metal components are thoroughly cleaned and coated electrostatically with an epoxy powder coat paint finish. The metal components are then oven baked and cured for a lasting finish.
TR-4212-A-M-30	Single Face Adder	29 ⁹ / ₁₆ "	13 ⁹ / ₁₆ "	42"	11 ¹ / ₂ "	2	2			\$ 1,135	
TR-4212-S-M-36	Single Face Shelving	36 ¹³ / ₁₆ "	13 ⁹ / ₁₆ "	42"	11 ¹ / ₂ "	2	2			\$ 1,275	Hinged metal magazine shelf with 12" height and 1" deep x ³ / ₄ " high lip.
TR-4212-A-M-36	Single Face Adder	35 ⁹ / ₁₆ "	13 ⁹ / ₁₆ "	42"	11 ¹ / ₂ "	2	2			\$ 1,034	
TR-4812-S-M-24	Single Face Shelving	24 ¹³ / ₁₆ "	13 ⁹ / ₁₆ "	48"	11 ¹ / ₂ "	3	3	67 Lbs.		\$ 1,748	
TR-4812-A-M-24	Single Face Adder	23 ⁹ / ₁₆ "	13 ⁹ / ₁₆ "	48"	11 ¹ / ₂ "	3	3	59 Lbs.		\$ 1,500	
TR-4812-S-M-30	Single Face Shelving	30 ¹³ / ₁₆ "	13 ⁹ / ₁₆ "	48"	11 ¹ / ₂ "	3	3			\$ 1,748	
TR-4812-A-M-30	Single Face Adder	29 ⁹ / ₁₆ "	13 ⁹ / ₁₆ "	48"	11 ¹ / ₂ "	3	3			\$ 1,500	
TR-4812-S-M-36	Single Face Shelving	36 ¹³ / ₁₆ "	13 ⁹ / ₁₆ "	48"	11 ¹ / ₂ "	3	3			\$ 1,624	
TR-4812-A-M-36	Single Face Adder	35 ⁹ / ₁₆ "	13 ⁹ / ₁₆ "	48"	11 ¹ / ₂ "	3	3			\$ 1,383	
TR-6612-S-M-24	Single Face Shelving	24 ¹³ / ₁₆ "	13 ⁹ / ₁₆ "	66"	11 ¹ / ₂ "	4	4	107 Lbs.		\$ 2,146	
TR-6612-A-M-24	Single Face Adder	23 ⁹ / ₁₆ "	13 ⁹ / ₁₆ "	66"	11 ¹ / ₂ "	4	4	95 Lbs.		\$ 1,865	
TR-6612-S-M-30	Single Face Shelving	30 ¹³ / ₁₆ "	13 ⁹ / ₁₆ "	66"	11 ¹ / ₂ "	4	4			\$ 2,146	
TR-6612-A-M-30	Single Face Adder	29 ⁹ / ₁₆ "	13 ⁹ / ₁₆ "	66"	11 ¹ / ₂ "	4	4			\$ 1,865	
TR-6612-S-M-36	Single Face Shelving	36 ¹³ / ₁₆ "	13 ⁹ / ₁₆ "	66"	11 ¹ / ₂ "	4	4			\$ 1,998	
TR-6612-A-M-36	Single Face Adder	35 ⁹ / ₁₆ "	13 ⁹ / ₁₆ "	66"	11 ¹ / ₂ "	4	4			\$ 1,717	
TR-7812-S-M-24	Single Face Shelving	24 ¹³ / ₁₆ "	13 ⁹ / ₁₆ "	78"	11 ¹ / ₂ "	5	5	129 Lbs.		\$ 2,551	
TR-7812-A-M-24	Single Face Adder	23 ⁹ / ₁₆ "	13 ⁹ / ₁₆ "	78"	11 ¹ / ₂ "	5	5	115 Lbs.		\$ 2,246	
TR-7812-S-M-30	Single Face Shelving	30 ¹³ / ₁₆ "	13 ⁹ / ₁₆ "	78"	11 ¹ / ₂ "	5	5			\$ 2,551	
TR-7812-A-M-30	Single Face Adder	29 ⁹ / ₁₆ "	13 ⁹ / ₁₆ "	78"	11 ¹ / ₂ "	5	5			\$ 2,246	
TR-7812-S-M-36	Single Face Shelving	36 ¹³ / ₁₆ "	13 ⁹ / ₁₆ "	78"	11 ¹ / ₂ "	5	5			\$ 2,363	
TR-7812-A-M-36	Single Face Adder	35 ⁹ / ₁₆ "	13 ⁹ / ₁₆ "	78"	11 ¹ / ₂ "	5	5			\$ 2,069	
TR-9012-S-M-24	Single Face Shelving	24 ¹³ / ₁₆ "	13 ⁹ / ₁₆ "	90"	11 ¹ / ₂ "	7	7	148 Lbs.		\$ 3,241	
TR-9012-A-M-24	Single Face Adder	23 ⁹ / ₁₆ "	13 ⁹ / ₁₆ "	90"	11 ¹ / ₂ "	7	7	132 Lbs.		\$ 2,868	
TR-9012-S-M-30	Single Face Shelving	30 ¹³ / ₁₆ "	13 ⁹ / ₁₆ "	90"	11 ¹ / ₂ "	7	7			\$ 3,241	
TR-9012-A-M-30	Single Face Adder	29 ⁹ / ₁₆ "	13 ⁹ / ₁₆ "	90"	11 ¹ / ₂ "	7	7			\$ 2,868	
TR-9012-S-M-36	Single Face Shelving	36 ¹³ / ₁₆ "	13 ⁹ / ₁₆ "	90"	11 ¹ / ₂ "	7	7			\$ 3,010	
TR-9012-A-M-36	Single Face Adder	35 ⁹ / ₁₆ "	13 ⁹ / ₁₆ "	90"	11 ¹ / ₂ "	7	7			\$ 2,636	



Model Shown
TR-4812-S-M-36



Model Shown
TR-6612-S-M-36



Model Shown
TR-7812-S-M-36



Model Shown
TR-9012-S-M-36

MODEL NUMBER	PRODUCT	WIDTH	DEPTH	HEIGHT	SHELF DEPTH	# OF SHELVES	# OF OPENINGS	WEIGHT	VOLUME	LIST PRICE	DESCRIPTION
TR-4224-S-M-24	Double Face Shelving	24 ^{13/16} "	25 ^{1/8} "	42"	11 ^{1/2} "	4	4	104 Lbs.		\$ 2,200	Made of a 1 ^{1/4} " x 2" metal frame with powder coat paint.
TR-4224-A-M-24	Double Face Adder	23 ^{9/16} "	25 ^{1/8} "	42"	11 ^{1/2} "	4	4	94 Lbs.		\$ 1,920	
TR-4224-S-M-30	Double Face Shelving	30 ^{13/16} "	25 ^{1/8} "	42"	11 ^{1/2} "	4	4			\$ 2,200	METAL FINISHING: All metal components are thoroughly cleaned and coated electrostatically with an epoxy powder coat paint finish. The metal components are then oven baked and cured for a lasting finish.
TR-4224-A-M-30	Double Face Adder	29 ^{9/16} "	25 ^{1/8} "	42"	11 ^{1/2} "	4	4			\$ 1,920	
TR-4224-S-M-36	Double Face Shelving	36 ^{13/16} "	25 ^{1/8} "	42"	11 ^{1/2} "	4	4			\$ 2,022	Hinged metal magazine shelf with 12" height and 1" deep x 3/4" high lip.
TR-4224-A-M-36	Double Face Adder	35 ^{9/16} "	25 ^{1/8} "	42"	11 ^{1/2} "	4	4			\$ 1,741	
TR-4824-S-M-24	Double Face Shelving	24 ^{13/16} "	25 ^{1/8} "	48"	11 ^{1/2} "	6	6	106 Lbs.		\$ 2,923	
TR-4824-A-M-24	Double Face Adder	23 ^{9/16} "	25 ^{1/8} "	48"	11 ^{1/2} "	6	6	96 Lbs.		\$ 2,628	
TR-4824-S-M-30	Double Face Shelving	30 ^{13/16} "	25 ^{1/8} "	48"	11 ^{1/2} "	6	6			\$ 2,923	
TR-4824-A-M-30	Double Face Adder	29 ^{9/16} "	25 ^{1/8} "	48"	11 ^{1/2} "	6	6			\$ 2,628	
TR-4824-S-M-36	Double Face Shelving	36 ^{13/16} "	25 ^{1/8} "	48"	11 ^{1/2} "	6	6			\$ 2,712	
TR-4824-A-M-36	Double Face Adder	35 ^{9/16} "	25 ^{1/8} "	48"	11 ^{1/2} "	6	6			\$ 2,425	
TR-6624-S-M-24	Double Face Shelving	24 ^{13/16} "	25 ^{1/8} "	66"	11 ^{1/2} "	8	8	182 Lbs.		\$ 3,654	
TR-6624-A-M-24	Double Face Adder	23 ^{9/16} "	25 ^{1/8} "	66"	11 ^{1/2} "	8	8	167 Lbs.		\$ 3,319	
TR-6624-S-M-30	Double Face Shelving	30 ^{13/16} "	25 ^{1/8} "	66"	11 ^{1/2} "	8	8			\$ 3,654	
TR-6624-A-M-30	Double Face Adder	29 ^{9/16} "	25 ^{1/8} "	66"	11 ^{1/2} "	8	8			\$ 3,319	
TR-6624-S-M-36	Double Face Shelving	36 ^{13/16} "	25 ^{1/8} "	66"	11 ^{1/2} "	8	8			\$ 3,382	
TR-6624-A-M-36	Double Face Adder	35 ^{9/16} "	25 ^{1/8} "	66"	11 ^{1/2} "	8	8			\$ 3,064	
TR-7824-S-M-24	Double Face Shelving	24 ^{13/16} "	25 ^{1/8} "	78"	11 ^{1/2} "	10	10	218 Lbs.		\$ 5,364	
TR-7824-A-M-24	Double Face Adder	23 ^{9/16} "	25 ^{1/8} "	78"	11 ^{1/2} "	10	10	202 Lbs.		\$ 4,073	
TR-7824-S-M-30	Double Face Shelving	30 ^{13/16} "	25 ^{1/8} "	78"	11 ^{1/2} "	10	10			\$ 5,364	
TR-7824-A-M-30	Double Face Adder	29 ^{9/16} "	25 ^{1/8} "	78"	11 ^{1/2} "	10	10			\$ 4,073	
TR-7824-S-M-36	Double Face Shelving	36 ^{13/16} "	25 ^{1/8} "	78"	11 ^{1/2} "	10	10			\$ 4,111	
TR-7824-A-M-36	Double Face Adder	35 ^{9/16} "	25 ^{1/8} "	78"	11 ^{1/2} "	10	10			\$ 3,763	
TR-9024-S-M-24	Double Face Shelving	24 ^{13/16} "	25 ^{1/8} "	90"	11 ^{1/2} "	14	14	255 Lbs.		\$ 5,682	
TR-9024-A-M-24	Double Face Adder	23 ^{9/16} "	25 ^{1/8} "	90"	11 ^{1/2} "	14	14	237 Lbs.		\$ 5,223	
TR-9024-S-M-30	Double Face Shelving	30 ^{13/16} "	25 ^{1/8} "	90"	11 ^{1/2} "	14	14			\$ 5,682	
TR-9024-A-M-30	Double Face Adder	29 ^{9/16} "	25 ^{1/8} "	90"	11 ^{1/2} "	14	14			\$ 5,223	
TR-9024-S-M-36	Double Face Shelving	36 ^{13/16} "	25 ^{1/8} "	90"	11 ^{1/2} "	14	14			\$ 5,247	
TR-9024-A-M-36	Double Face Adder	35 ^{9/16} "	25 ^{1/8} "	90"	11 ^{1/2} "	14	14			\$ 4,820	



Model Shown
TR-4824-S-M-36



Model Shown
TR-6624-S-M-36



Model Shown
TR-7824-S-M-36



Model Shown
TR-9024-S-M-36
PG 22





Model Shown
TR-4812-S-P-36

MODEL NUMBER	PRODUCT	WIDTH	DEPTH	HEIGHT	SHELF DEPTH	# OF SHELVES	# OF OPENINGS	WEIGHT	VOLUME	LIST PRICE	DESCRIPTION
TR-4210-S-P-24	Single Face Shelving	24 ^{13/16"}	11 ^{9/16"}	42"	9 ^{1/2"}	3	3			\$ 1,531	Made of a 1 ^{1/4"} x 2" metal frame with powder coat paint.
TR-4210-A-P-24	Single Face Adder	23 ^{9/16"}	11 ^{9/16"}	42"	9 ^{1/2"}	3	3			\$ 1,306	
TR-4212-S-P-24	Single Face Shelving	24 ^{13/16"}	13 ^{9/16"}	42"	11 ^{1/2"}	3	3			\$ 1,563	METAL FINISHING: All metal components are thoroughly cleaned and coated electrostatically with an epoxy powder coat paint finish. The metal components are then oven baked and cured for a lasting finish.
TR-4212-A-P-24	Single Face Adder	23 ^{9/16"}	13 ^{9/16"}	42"	11 ^{1/2"}	3	3			\$ 1,329	
TR-4210-S-P-30	Single Face Shelving	30 ^{13/16"}	11 ^{9/16"}	42"	9 ^{1/2"}	3	3			\$ 1,531	Divider shelf is 5" high with 3 metal dividers. Shelf is slotted at 2" intervals.
TR-4210-A-P-30	Single Face Adder	29 ^{9/16"}	11 ^{9/16"}	42"	9 ^{1/2"}	3	3			\$ 1,306	
TR-4212-S-P-30	Single Face Shelving	30 ^{13/16"}	13 ^{9/16"}	42"	11 ^{1/2"}	3	3			\$ 1,563	
TR-4212-A-P-30	Single Face Adder	29 ^{9/16"}	13 ^{9/16"}	42"	11 ^{1/2"}	3	3			\$ 1,329	
TR-4210-S-P-36	Single Face Shelving	36 ^{13/16"}	11 ^{9/16"}	42"	9 ^{1/2"}	3	3	81 Lbs.		\$ 1,493	
TR-4210-A-P-36	Single Face Adder	35 ^{9/16"}	11 ^{9/16"}	42"	9 ^{1/2"}	3	3	73 Lbs.		\$ 1,268	
TR-4212-S-P-36	Single Face Shelving	36 ^{13/16"}	13 ^{9/16"}	42"	11 ^{1/2"}	3	3	91 Lbs.		\$ 1,524	
TR-4212-A-P-36	Single Face Adder	35 ^{9/16"}	13 ^{9/16"}	42"	11 ^{1/2"}	3	3	83 Lbs.		\$ 1,282	
TR-4810-S-P-24	Single Face Shelving	24 ^{13/16"}	11 ^{9/16"}	48"	9 ^{1/2"}	3	3			\$ 1,563	
TR-4810-A-P-24	Single Face Adder	23 ^{9/16"}	11 ^{9/16"}	48"	9 ^{1/2"}	3	3			\$ 1,329	
TR-4812-S-P-24	Single Face Shelving	24 ^{13/16"}	13 ^{9/16"}	48"	11 ^{1/2"}	3	3			\$ 1,593	
TR-4812-A-P-24	Single Face Adder	23 ^{9/16"}	13 ^{9/16"}	48"	11 ^{1/2"}	3	3			\$ 1,360	
TR-4810-S-P-30	Single Face Shelving	30 ^{13/16"}	11 ^{9/16"}	48"	9 ^{1/2"}	3	3			\$ 1,563	
TR-4810-A-P-30	Single Face Adder	29 ^{9/16"}	11 ^{9/16"}	48"	9 ^{1/2"}	3	3			\$ 1,329	
TR-4812-S-P-30	Single Face Shelving	30 ^{13/16"}	13 ^{9/16"}	48"	11 ^{1/2"}	3	3			\$ 1,593	
TR-4812-A-P-30	Single Face Adder	29 ^{9/16"}	13 ^{9/16"}	48"	11 ^{1/2"}	3	3			\$ 1,360	
TR-4810-S-P-36	Single Face Shelving	36 ^{13/16"}	11 ^{9/16"}	48"	9 ^{1/2"}	3	3	82 Lbs.		\$ 1,524	
TR-4810-A-P-36	Single Face Adder	35 ^{9/16"}	11 ^{9/16"}	48"	9 ^{1/2"}	3	3	74 Lbs.		\$ 1,298	
TR-4812-S-P-36	Single Face Shelving	36 ^{13/16"}	13 ^{9/16"}	48"	11 ^{1/2"}	3	3	92 Lbs.		\$ 1,555	
TR-4812-A-P-36	Single Face Adder	35 ^{9/16"}	13 ^{9/16"}	48"	11 ^{1/2"}	3	3	84 Lbs.		\$ 1,306	
TR-6610-S-P-24	Single Face Shelving	24 ^{13/16"}	11 ^{9/16"}	66"	9 ^{1/2"}	4	4			\$ 1,920	
TR-6610-A-P-24	Single Face Adder	23 ^{9/16"}	11 ^{9/16"}	66"	9 ^{1/2"}	4	4			\$ 1,656	
TR-6612-S-P-24	Single Face Shelving	24 ^{13/16"}	13 ^{9/16"}	66"	11 ^{1/2"}	4	4			\$ 1,945	
TR-6612-A-P-24	Single Face Adder	23 ^{9/16"}	13 ^{9/16"}	66"	11 ^{1/2"}	4	4			\$ 1,680	
TR-6610-S-P-30	Single Face Shelving	30 ^{13/16"}	11 ^{9/16"}	66"	9 ^{1/2"}	4	4			\$ 1,920	
TR-6610-A-P-30	Single Face Adder	29 ^{9/16"}	11 ^{9/16"}	66"	9 ^{1/2"}	4	4			\$ 1,656	
TR-6612-S-P-30	Single Face Shelving	30 ^{13/16"}	13 ^{9/16"}	66"	11 ^{1/2"}	4	4			\$ 1,945	
TR-6612-A-P-30	Single Face Adder	29 ^{9/16"}	13 ^{9/16"}	66"	11 ^{1/2"}	4	4			\$ 1,680	
TR-6610-S-P-36	Single Face Shelving	36 ^{13/16"}	11 ^{9/16"}	66"	9 ^{1/2"}	4	4	105 Lbs.		\$ 1,858	
TR-6610-A-P-36	Single Face Adder	35 ^{9/16"}	11 ^{9/16"}	66"	9 ^{1/2"}	4	4	94 Lbs.		\$ 1,593	
TR-6612-S-P-36	Single Face Shelving	36 ^{13/16"}	13 ^{9/16"}	66"	11 ^{1/2"}	4	4	118 Lbs.		\$ 1,897	
TR-6612-A-P-36	Single Face Adder	35 ^{9/16"}	13 ^{9/16"}	66"	11 ^{1/2"}	4	4	106 Lbs.		\$ 1,624	



Model Shown
TR-6612-S-P-36

MODEL NUMBER	PRODUCT	WIDTH	DEPTH	HEIGHT	SHELF DEPTH	# OF SHELVES	# OF OPENINGS	WEIGHT	VOLUME	LIST PRICE	DESCRIPTION
 <p>Model Shown TR-7812-S-P-36</p>	TR-7810-S-P-24	Single Face Shelving	24 ^{13/16"}	11 ^{9/16"}	78"	9 ^{1/2"}	5			\$ 2,270	<p>Made of a 1^{1/4"} x 2" metal frame with powder coat paint.</p> <p>METAL FINISHING: All metal components are thoroughly cleaned and coated electrostatically with an epoxy powder coat paint finish. The metal components are then oven baked and cured for a lasting finish.</p> <p>Divider shelf is 5" high with 3 metal dividers. Shelf is slotted at 2" intervals.</p>
	TR-7810-A-P-24	Single Face Adder	23 ^{9/16"}	11 ^{9/16"}	78"	9 ^{1/2"}	5			\$ 1,983	
	TR-7812-S-P-24	Single Face Shelving	24 ^{13/16"}	13 ^{9/16"}	78"	11 ^{1/2"}	5			\$ 2,309	
	TR-7812-A-P-24	Single Face Adder	23 ^{9/16"}	13 ^{9/16"}	78"	11 ^{1/2"}	5			\$ 2,022	
	TR-7810-S-P-30	Single Face Shelving	30 ^{13/16"}	11 ^{9/16"}	78"	9 ^{1/2"}	5			\$ 2,270	
	TR-7810-A-P-30	Single Face Adder	29 ^{9/16"}	11 ^{9/16"}	78"	9 ^{1/2"}	5			\$ 1,983	
	TR-7812-S-P-30	Single Face Shelving	30 ^{13/16"}	13 ^{9/16"}	78"	11 ^{1/2"}	5			\$ 2,309	
	TR-7812-A-P-30	Single Face Adder	29 ^{9/16"}	13 ^{9/16"}	78"	11 ^{1/2"}	5			\$ 2,022	
	TR-7810-S-P-36	Single Face Shelving	36 ^{13/16"}	11 ^{9/16"}	78"	9 ^{1/2"}	5		144 Lbs.	\$ 2,200	
	TR-7810-A-P-36	Single Face Adder	35 ^{9/16"}	11 ^{9/16"}	78"	9 ^{1/2"}	5		130 Lbs.	\$ 1,920	
	TR-7812-S-P-36	Single Face Shelving	36 ^{13/16"}	13 ^{9/16"}	78"	11 ^{1/2"}	5		145 Lbs.	\$ 2,239	
	TR-7812-A-P-36	Single Face Adder	35 ^{9/16"}	13 ^{9/16"}	78"	11 ^{1/2"}	5		131 Lbs.	\$ 1,945	
 <p>Model Shown TR-8412-S-P-36</p>	TR-8410-S-P-24	Single Face Shelving	24 ^{13/16"}	11 ^{9/16"}	84"	9 ^{1/2"}	6			\$ 2,643	
	TR-8410-A-P-24	Single Face Adder	23 ^{9/16"}	11 ^{9/16"}	84"	9 ^{1/2"}	6			\$ 2,324	
	TR-8412-S-P-24	Single Face Shelving	24 ^{13/16"}	13 ^{9/16"}	84"	11 ^{1/2"}	6			\$ 2,690	
	TR-8412-A-P-24	Single Face Adder	23 ^{9/16"}	13 ^{9/16"}	84"	11 ^{1/2"}	6			\$ 2,363	
	TR-8410-S-P-30	Single Face Shelving	30 ^{13/16"}	11 ^{9/16"}	84"	9 ^{1/2"}	6			\$ 2,643	
	TR-8410-A-P-30	Single Face Adder	29 ^{9/16"}	11 ^{9/16"}	84"	9 ^{1/2"}	6			\$ 2,324	
	TR-8412-S-P-30	Single Face Shelving	30 ^{13/16"}	13 ^{9/16"}	84"	11 ^{1/2"}	6			\$ 2,690	
	TR-8412-A-P-30	Single Face Adder	29 ^{9/16"}	13 ^{9/16"}	84"	11 ^{1/2"}	6			\$ 2,363	
	TR-8410-S-P-36	Single Face Shelving	36 ^{13/16"}	11 ^{9/16"}	84"	9 ^{1/2"}	6		146 Lbs.	\$ 2,558	
	TR-8410-A-P-36	Single Face Adder	35 ^{9/16"}	11 ^{9/16"}	84"	9 ^{1/2"}	6		132 Lbs.	\$ 2,239	
	TR-8412-S-P-36	Single Face Shelving	36 ^{13/16"}	13 ^{9/16"}	84"	11 ^{1/2"}	6		147 Lbs.	\$ 2,605	
	TR-8412-A-P-36	Single Face Adder	35 ^{9/16"}	13 ^{9/16"}	84"	11 ^{1/2"}	6		133 Lbs.	\$ 2,277	
 <p>Model Shown TR-9012-S-P-36</p>	TR-9010-S-P-24	Single Face Shelving	24 ^{13/16"}	11 ^{9/16"}	90"	9 ^{1/2"}	7			\$ 3,023	
	TR-9010-A-P-24	Single Face Adder	23 ^{9/16"}	11 ^{9/16"}	90"	9 ^{1/2"}	7			\$ 2,675	
	TR-9012-S-P-24	Single Face Shelving	24 ^{13/16"}	13 ^{9/16"}	90"	11 ^{1/2"}	7			\$ 3,085	
	TR-9012-A-P-24	Single Face Adder	23 ^{9/16"}	13 ^{9/16"}	90"	11 ^{1/2"}	7			\$ 2,722	
	TR-9010-S-P-30	Single Face Shelving	30 ^{13/16"}	11 ^{9/16"}	90"	9 ^{1/2"}	7			\$ 3,023	
	TR-9010-A-P-30	Single Face Adder	29 ^{9/16"}	11 ^{9/16"}	90"	9 ^{1/2"}	7			\$ 2,675	
	TR-9012-S-P-30	Single Face Shelving	30 ^{13/16"}	13 ^{9/16"}	90"	11 ^{1/2"}	7			\$ 3,085	
	TR-9012-A-P-30	Single Face Adder	29 ^{9/16"}	13 ^{9/16"}	90"	11 ^{1/2"}	7			\$ 2,722	
	TR-9010-S-P-36	Single Face Shelving	36 ^{13/16"}	11 ^{9/16"}	90"	9 ^{1/2"}	7		164 Lbs.	\$ 2,884	
	TR-9010-A-P-36	Single Face Adder	35 ^{9/16"}	11 ^{9/16"}	90"	9 ^{1/2"}	7		149 Lbs.	\$ 2,581	
	TR-9012-S-P-36	Single Face Shelving	36 ^{13/16"}	13 ^{9/16"}	90"	11 ^{1/2"}	7		165 Lbs.	\$ 2,992	
	TR-9012-A-P-36	Single Face Adder	35 ^{9/16"}	13 ^{9/16"}	90"	11 ^{1/2"}	7		150 Lbs.	\$ 2,619	









Model Shown
TR-4824-S-P-36



MODEL NUMBER	PRODUCT	WIDTH	DEPTH	HEIGHT	SHELF DEPTH	# OF SHELVES	# OF OPENINGS	WEIGHT	VOLUME	LIST PRICE	DESCRIPTION
TR-4220-S-P-24	Double Face Shelving	24 ^{13/16} "	21 ^{1/8} "	42"	9 ^{1/2} "	6	6			\$ 2,542	Made of a 1 ^{1/4} " x 2" metal frame with powder coat paint.
TR-4220-A-P-24	Double Face Adder	23 ^{9/16} "	21 ^{1/8} "	42"	9 ^{1/2} "	6	6			\$ 2,270	
TR-4224-S-P-24	Double Face Shelving	24 ^{13/16} "	25 ^{1/8} "	42"	11 ^{1/2} "	6	6			\$ 2,588	METAL FINISHING: All metal components are thoroughly cleaned and coated electrostatically with an epoxy powder coat paint finish. The metal components are then oven baked and cured for a lasting finish.
TR-4224-A-P-24	Double Face Adder	23 ^{9/16} "	25 ^{1/8} "	42"	11 ^{1/2} "	6	6			\$ 2,317	
TR-4220-S-P-30	Double Face Shelving	30 ^{13/16} "	21 ^{1/8} "	42"	9 ^{1/2} "	6	6			\$ 2,542	Divider shelf is 5" high with 3 metal dividers. Shelf is slotted at 2" intervals.
TR-4220-A-P-30	Double Face Adder	29 ^{9/16} "	21 ^{1/8} "	42"	9 ^{1/2} "	6	6			\$ 2,270	
TR-4224-S-P-30	Double Face Shelving	30 ^{13/16} "	25 ^{1/8} "	42"	11 ^{1/2} "	6	6			\$ 2,588	
TR-4224-A-P-30	Double Face Adder	29 ^{9/16} "	25 ^{1/8} "	42"	11 ^{1/2} "	6	6			\$ 2,317	
TR-4220-S-P-36	Double Face Shelving	36 ^{13/16} "	21 ^{1/8} "	42"	9 ^{1/2} "	6	6	136 Lbs.		\$ 2,463	
TR-4220-A-P-36	Double Face Adder	35 ^{9/16} "	21 ^{1/8} "	42"	9 ^{1/2} "	6	6	127 Lbs.		\$ 2,193	
TR-4224-S-P-36	Double Face Shelving	36 ^{13/16} "	25 ^{1/8} "	42"	11 ^{1/2} "	6	6	138 Lbs.		\$ 2,512	
TR-4224-A-P-36	Double Face Adder	35 ^{9/16} "	25 ^{1/8} "	42"	11 ^{1/2} "	6	6	129 Lbs.		\$ 2,231	
TR-4820-S-P-24	Double Face Shelving	24 ^{13/16} "	21 ^{1/8} "	48"	9 ^{1/2} "	6	6			\$ 2,588	
TR-4820-A-P-24	Double Face Adder	23 ^{9/16} "	21 ^{1/8} "	48"	9 ^{1/2} "	6	6			\$ 2,317	
TR-4824-S-P-24	Double Face Shelving	24 ^{13/16} "	25 ^{1/8} "	48"	11 ^{1/2} "	6	6			\$ 2,643	
TR-4824-A-P-24	Double Face Adder	23 ^{9/16} "	25 ^{1/8} "	48"	11 ^{1/2} "	6	6			\$ 2,356	
TR-4820-S-P-30	Double Face Shelving	30 ^{13/16} "	21 ^{1/8} "	48"	9 ^{1/2} "	6	6			\$ 2,588	
TR-4820-A-P-30	Double Face Adder	29 ^{9/16} "	21 ^{1/8} "	48"	9 ^{1/2} "	6	6			\$ 2,317	
TR-4824-S-P-30	Double Face Shelving	30 ^{13/16} "	25 ^{1/8} "	48"	11 ^{1/2} "	6	6			\$ 2,643	
TR-4824-A-P-30	Double Face Adder	29 ^{9/16} "	25 ^{1/8} "	48"	11 ^{1/2} "	6	6			\$ 2,356	
TR-4820-S-P-36	Double Face Shelving	36 ^{13/16} "	21 ^{1/8} "	48"	9 ^{1/2} "	6	6	138 Lbs.		\$ 2,512	
TR-4820-A-P-36	Double Face Adder	35 ^{9/16} "	21 ^{1/8} "	48"	9 ^{1/2} "	6	6	129 Lbs.		\$ 2,231	
TR-4824-S-P-36	Double Face Shelving	36 ^{13/16} "	25 ^{1/8} "	48"	11 ^{1/2} "	6	6	140 Lbs.		\$ 2,558	
TR-4824-A-P-36	Double Face Adder	35 ^{9/16} "	25 ^{1/8} "	48"	11 ^{1/2} "	6	6	131 Lbs.		\$ 2,277	
TR-6620-S-P-24	Double Face Shelving	24 ^{13/16} "	21 ^{1/8} "	66"	9 ^{1/2} "	8	8			\$ 3,227	
TR-6620-A-P-24	Double Face Adder	23 ^{9/16} "	21 ^{1/8} "	66"	9 ^{1/2} "	8	8			\$ 2,915	
TR-6624-S-P-24	Double Face Shelving	24 ^{13/16} "	25 ^{1/8} "	66"	11 ^{1/2} "	8	8			\$ 3,258	
TR-6624-A-P-24	Double Face Adder	23 ^{9/16} "	25 ^{1/8} "	66"	11 ^{1/2} "	8	8			\$ 2,946	
TR-6620-S-P-30	Double Face Shelving	30 ^{13/16} "	21 ^{1/8} "	66"	9 ^{1/2} "	8	8			\$ 3,227	
TR-6620-A-P-30	Double Face Adder	29 ^{9/16} "	21 ^{1/8} "	66"	9 ^{1/2} "	8	8			\$ 2,915	
TR-6624-S-P-30	Double Face Shelving	30 ^{13/16} "	25 ^{1/8} "	66"	11 ^{1/2} "	8	8			\$ 3,258	
TR-6624-A-P-30	Double Face Adder	29 ^{9/16} "	25 ^{1/8} "	66"	11 ^{1/2} "	8	8			\$ 2,946	
TR-6620-S-P-36	Double Face Shelving	36 ^{13/16} "	21 ^{1/8} "	66"	9 ^{1/2} "	8	8	178 Lbs.		\$ 3,102	
TR-6620-A-P-36	Double Face Adder	35 ^{9/16} "	21 ^{1/8} "	66"	9 ^{1/2} "	8	8	165 Lbs.		\$ 2,791	
TR-6624-S-P-36	Double Face Shelving	36 ^{13/16} "	25 ^{1/8} "	66"	11 ^{1/2} "	8	8	204 Lbs.		\$ 3,157	
TR-6624-A-P-36	Double Face Adder	35 ^{9/16} "	25 ^{1/8} "	66"	11 ^{1/2} "	8	8	190 Lbs.		\$ 2,846	



Model Shown
TR-6624-S-P-36

MODEL NUMBER	PRODUCT	WIDTH	DEPTH	HEIGHT	SHELF DEPTH	# OF SHELVES	# OF OPENINGS	WEIGHT	VOLUME	LIST PRICE	DESCRIPTION
 <p>Model Shown TR-7824-S-P-36</p>	TR-7820-S-P-24	Double Face Shelving	24 ^{13/16} "	21 ^{1/8} "	78"	9 ^{1/2} "	10			\$ 3,918	<p>Made of a 1^{1/4}" x 2" metal frame with powder coat paint.</p> <p>METAL FINISHING: All metal components are thoroughly cleaned and coated electrostatically with an epoxy powder coat paint finish. The metal components are then oven baked and cured for a lasting finish.</p> <p>Divider shelf is 5" high with 3 metal dividers. Shelf is slotted at 2" intervals.</p>
	TR-7820-A-P-24	Double Face Adder	23 ^{9/16} "	21 ^{1/8} "	78"	9 ^{1/2} "	10			\$ 3,575	
	TR-7824-S-P-24	Double Face Shelving	24 ^{13/16} "	25 ^{1/8} "	78"	11 ^{1/2} "	10			\$ 3,995	
	TR-7824-A-P-24	Double Face Adder	23 ^{9/16} "	25 ^{1/8} "	78"	11 ^{1/2} "	10			\$ 3,639	
	TR-7820-S-P-30	Double Face Shelving	30 ^{13/16} "	21 ^{1/8} "	78"	9 ^{1/2} "	10			\$ 3,918	
	TR-7820-A-P-30	Double Face Adder	29 ^{9/16} "	21 ^{1/8} "	78"	9 ^{1/2} "	10			\$ 3,575	
	TR-7824-S-P-30	Double Face Shelving	30 ^{13/16} "	25 ^{1/8} "	78"	11 ^{1/2} "	10			\$ 3,995	
	TR-7824-A-P-30	Double Face Adder	29 ^{9/16} "	25 ^{1/8} "	78"	11 ^{1/2} "	10			\$ 3,639	
	TR-7820-S-P-36	Double Face Shelving	36 ^{13/16} "	21 ^{1/8} "	78"	9 ^{1/2} "	10		250 Lbs.	\$ 3,801	
	TR-7820-A-P-36	Double Face Adder	35 ^{9/16} "	21 ^{1/8} "	78"	9 ^{1/2} "	10		235 Lbs.	\$ 3,451	
	TR-7824-S-P-36	Double Face Shelving	36 ^{13/16} "	25 ^{1/8} "	78"	11 ^{1/2} "	10		288 Lbs.	\$ 3,871	
	TR-7824-A-P-36	Double Face Adder	35 ^{9/16} "	25 ^{1/8} "	78"	11 ^{1/2} "	10		271 Lbs.	\$ 3,514	
 <p>Model Shown TR-8424-S-P-36</p>	TR-8420-S-P-24	Double Face Shelving	24 ^{13/16} "	21 ^{1/8} "	84"	9 ^{1/2} "	12			\$ 4,594	
	TR-8420-A-P-24	Double Face Adder	23 ^{9/16} "	21 ^{1/8} "	84"	9 ^{1/2} "	12			\$ 4,215	
	TR-8424-S-P-24	Double Face Shelving	24 ^{13/16} "	25 ^{1/8} "	84"	11 ^{1/2} "	12			\$ 4,681	
	TR-8424-A-P-24	Double Face Adder	23 ^{9/16} "	25 ^{1/8} "	84"	11 ^{1/2} "	12			\$ 4,292	
	TR-8420-S-P-30	Double Face Shelving	30 ^{13/16} "	21 ^{1/8} "	84"	9 ^{1/2} "	12			\$ 4,594	
	TR-8420-A-P-30	Double Face Adder	29 ^{9/16} "	21 ^{1/8} "	84"	9 ^{1/2} "	12			\$ 4,215	
	TR-8424-S-P-30	Double Face Shelving	30 ^{13/16} "	25 ^{1/8} "	84"	11 ^{1/2} "	12			\$ 4,681	
	TR-8424-A-P-30	Double Face Adder	29 ^{9/16} "	25 ^{1/8} "	84"	11 ^{1/2} "	12			\$ 4,292	
	TR-8420-S-P-36	Double Face Shelving	36 ^{13/16} "	21 ^{1/8} "	84"	9 ^{1/2} "	12		255 Lbs.	\$ 4,470	
	TR-8420-A-P-36	Double Face Adder	35 ^{9/16} "	21 ^{1/8} "	84"	9 ^{1/2} "	12		240 Lbs.	\$ 4,089	
	TR-8424-S-P-36	Double Face Shelving	36 ^{13/16} "	25 ^{1/8} "	84"	11 ^{1/2} "	12		293 Lbs.	\$ 4,563	
	TR-8424-A-P-36	Double Face Adder	35 ^{9/16} "	25 ^{1/8} "	84"	11 ^{1/2} "	12		240 Lbs.	\$ 4,158	
 <p>Model Shown TR-9024-S-P-36</p>	TR-9020-S-P-24	Double Face Shelving	24 ^{13/16} "	21 ^{1/8} "	90"	9 ^{1/2} "	14			\$ 5,293	
	TR-9020-A-P-24	Double Face Adder	23 ^{9/16} "	21 ^{1/8} "	90"	9 ^{1/2} "	14			\$ 4,867	
	TR-9024-S-P-24	Double Face Shelving	24 ^{13/16} "	25 ^{1/8} "	90"	11 ^{1/2} "	14			\$ 5,387	
	TR-9024-A-P-24	Double Face Adder	23 ^{9/16} "	25 ^{1/8} "	90"	11 ^{1/2} "	14			\$ 4,951	
	TR-9020-S-P-30	Double Face Shelving	30 ^{13/16} "	21 ^{1/8} "	90"	9 ^{1/2} "	14			\$ 5,293	
	TR-9020-A-P-30	Double Face Adder	29 ^{9/16} "	21 ^{1/8} "	90"	9 ^{1/2} "	14			\$ 4,867	
	TR-9024-S-P-30	Double Face Shelving	30 ^{13/16} "	25 ^{1/8} "	90"	11 ^{1/2} "	14			\$ 5,387	
	TR-9024-A-P-30	Double Face Adder	29 ^{9/16} "	25 ^{1/8} "	90"	11 ^{1/2} "	14			\$ 4,951	
	TR-9020-S-P-36	Double Face Shelving	36 ^{13/16} "	21 ^{1/8} "	90"	9 ^{1/2} "	14		246 Lbs.	\$ 5,130	
	TR-9020-A-P-36	Double Face Adder	35 ^{9/16} "	21 ^{1/8} "	90"	9 ^{1/2} "	14		228 Lbs.	\$ 4,702	
	TR-9024-S-P-36	Double Face Shelving	36 ^{13/16} "	25 ^{1/8} "	90"	11 ^{1/2} "	14		251 Lbs.	\$ 5,223	
	TR-9024-A-P-36	Double Face Adder	35 ^{9/16} "	25 ^{1/8} "	90"	11 ^{1/2} "	14		233 Lbs.	\$ 4,797	

	MODEL NUMBER	PRODUCT	WIDTH	DEPTH	HEIGHT	SHELF DEPTH	# OF SHELVES	# OF OPENINGS	WEIGHT	VOLUME	LIST PRICE	DESCRIPTION
 <p>Model Shown TR-3612-S-BB-36</p>	TR-3610-S-BB-24	Single Face Shelving	24 ^{13/16} "	11 ^{9/16} "	36"	9 ^{1/2} "	2	2			\$ 1,463	<p>Made of a 1^{1/4}" x 2" metal frame with powder coat paint.</p> <p>METAL FINISHING: All metal components are thoroughly cleaned and coated electrostatically with an epoxy powder coat paint finish. The metal components are then oven baked and cured for a lasting finish.</p> <p>Browser box shelf is 5" high with 6 compartments and 5 removable rods to accomodate various media.</p>
	TR-3610-A-BB-24	Single Face Adder	23 ^{9/16} "	11 ^{9/16} "	36"	9 ^{1/2} "	2	2			\$ 1,178	
	TR-3612-S-BB-24	Single Face Shelving	24 ^{13/16} "	13 ^{9/16} "	36"	11 ^{1/2} "	2	2			\$ 1,482	
	TR-3612-A-BB-24	Single Face Adder	23 ^{9/16} "	13 ^{9/16} "	36"	11 ^{1/2} "	2	2			\$ 1,328	
	TR-3610-S-BB-30	Single Face Shelving	30 ^{13/16} "	11 ^{9/16} "	36"	9 ^{1/2} "	2	2			\$ 1,463	
	TR-3610-A-BB-30	Single Face Adder	29 ^{9/16} "	11 ^{9/16} "	36"	9 ^{1/2} "	2	2			\$ 1,178	
	TR-3612-S-BB-30	Single Face Shelving	30 ^{13/16} "	13 ^{9/16} "	36"	11 ^{1/2} "	2	2			\$ 1,482	
	TR-3612-A-BB-30	Single Face Adder	29 ^{9/16} "	13 ^{9/16} "	36"	11 ^{1/2} "	2	2			\$ 1,328	
	TR-3610-S-BB-36	Single Face Shelving	36 ^{13/16} "	11 ^{9/16} "	36"	9 ^{1/2} "	2	2			\$ 1,438	
	TR-3610-A-BB-36	Single Face Adder	35 ^{9/16} "	11 ^{9/16} "	36"	9 ^{1/2} "	2	2			\$ 1,287	
	TR-3612-S-BB-36	Single Face Shelving	36 ^{13/16} "	13 ^{9/16} "	36"	11 ^{1/2} "	2	2			\$ 1,457	
	TR-3612-A-BB-36	Single Face Adder	35 ^{9/16} "	13 ^{9/16} "	36"	11 ^{1/2} "	2	2			\$ 1,297	
 <p>Model Shown TR-4212-S-BB-36</p>	TR-4210-S-BB-24	Single Face Shelving	24 ^{13/16} "	11 ^{9/16} "	42"	9 ^{1/2} "	3	3			\$ 1,973	
	TR-4210-A-BB-24	Single Face Adder	23 ^{9/16} "	11 ^{9/16} "	42"	9 ^{1/2} "	3	3			\$ 1,748	
	TR-4212-S-BB-24	Single Face Shelving	24 ^{13/16} "	13 ^{9/16} "	42"	11 ^{1/2} "	3	3			\$ 2,004	
	TR-4212-A-BB-24	Single Face Adder	23 ^{9/16} "	13 ^{9/16} "	42"	11 ^{1/2} "	3	3			\$ 1,771	
	TR-4210-S-BB-30	Single Face Shelving	30 ^{13/16} "	11 ^{9/16} "	42"	9 ^{1/2} "	3	3			\$ 1,973	
	TR-4210-A-BB-30	Single Face Adder	29 ^{9/16} "	11 ^{9/16} "	42"	9 ^{1/2} "	3	3			\$ 1,748	
	TR-4212-S-BB-30	Single Face Shelving	30 ^{13/16} "	13 ^{9/16} "	42"	11 ^{1/2} "	3	3			\$ 2,004	
	TR-4212-A-BB-30	Single Face Adder	29 ^{9/16} "	13 ^{9/16} "	42"	11 ^{1/2} "	3	3			\$ 1,771	
	TR-4210-S-BB-36	Single Face Shelving	36 ^{13/16} "	11 ^{9/16} "	42"	9 ^{1/2} "	3	3			\$ 1,934	
	TR-4210-A-BB-36	Single Face Adder	35 ^{9/16} "	11 ^{9/16} "	42"	9 ^{1/2} "	3	3			\$ 1,710	
	TR-4212-S-BB-36	Single Face Shelving	36 ^{13/16} "	13 ^{9/16} "	42"	11 ^{1/2} "	3	3			\$ 1,965	
	TR-4212-A-BB-36	Single Face Adder	35 ^{9/16} "	13 ^{9/16} "	42"	11 ^{1/2} "	3	3			\$ 1,724	
 <p>Model Shown TR-4812-S-BB-36</p>	TR-4810-S-BB-24	Single Face Shelving	24 ^{13/16} "	11 ^{9/16} "	48"	9 ^{1/2} "	3	3			\$ 2,004	
	TR-4810-A-BB-24	Single Face Adder	23 ^{9/16} "	11 ^{9/16} "	48"	9 ^{1/2} "	3	3			\$ 1,771	
	TR-4812-S-BB-24	Single Face Shelving	24 ^{13/16} "	13 ^{9/16} "	48"	11 ^{1/2} "	3	3			\$ 2,034	
	TR-4812-A-BB-24	Single Face Adder	23 ^{9/16} "	13 ^{9/16} "	48"	11 ^{1/2} "	3	3			\$ 1,803	
	TR-4810-S-BB-30	Single Face Shelving	30 ^{13/16} "	11 ^{9/16} "	48"	9 ^{1/2} "	3	3			\$ 2,004	
	TR-4810-A-BB-30	Single Face Adder	29 ^{9/16} "	11 ^{9/16} "	48"	9 ^{1/2} "	3	3			\$ 1,771	
	TR-4812-S-BB-30	Single Face Shelving	30 ^{13/16} "	13 ^{9/16} "	48"	11 ^{1/2} "	3	3			\$ 2,034	
	TR-4812-A-BB-30	Single Face Adder	29 ^{9/16} "	13 ^{9/16} "	48"	11 ^{1/2} "	3	3			\$ 1,803	
	TR-4810-S-BB-36	Single Face Shelving	36 ^{13/16} "	11 ^{9/16} "	48"	9 ^{1/2} "	3	3			\$ 1,965	
	TR-4810-A-BB-36	Single Face Adder	35 ^{9/16} "	11 ^{9/16} "	48"	9 ^{1/2} "	3	3			\$ 1,740	
	TR-4812-S-BB-36	Single Face Shelving	36 ^{13/16} "	13 ^{9/16} "	48"	11 ^{1/2} "	3	3			\$ 1,998	
	TR-4812-A-BB-36	Single Face Adder	35 ^{9/16} "	13 ^{9/16} "	48"	11 ^{1/2} "	3	3			\$ 1,748	

	MODEL NUMBER	PRODUCT	WIDTH	DEPTH	HEIGHT	SHELF DEPTH	# OF SHELVES	# OF OPENINGS	WEIGHT	VOLUME	LIST PRICE	DESCRIPTION
 <p>Model Shown TR-5412-S-BB-36</p>	TR-5410-S-BB-24	Single Face Shelving	24 ^{13/16} "	11 ^{9/16} "	54"	9 ^{1/2} "	4	4			\$ 2,479	<p>Made of a 1^{1/4}" x 2" metal frame with powder coat paint.</p> <p>METAL FINISHING: All metal components are thoroughly cleaned and coated electrostatically with an epoxy powder coat paint finish. The metal components are then oven baked and cured for a lasting finish.</p> <p>Browser box shelf is 5" high with 6 compartments and 5 removable rods to accomodate various media.</p>
	TR-5410-A-BB-24	Single Face Adder	23 ^{9/16} "	11 ^{9/16} "	54"	9 ^{1/2} "	4	4			\$ 2,223	
	TR-5412-S-BB-24	Single Face Shelving	24 ^{13/16} "	13 ^{9/16} "	54"	11 ^{1/2} "	4	4			\$ 2,505	
	TR-5412-A-BB-24	Single Face Adder	23 ^{9/16} "	13 ^{9/16} "	54"	11 ^{1/2} "	4	4			\$ 2,239	
	TR-5410-S-BB-30	Single Face Shelving	30 ^{13/16} "	11 ^{9/16} "	54"	9 ^{1/2} "	4	4			\$ 2,479	
	TR-5410-A-BB-30	Single Face Adder	29 ^{9/16} "	11 ^{9/16} "	54"	9 ^{1/2} "	4	4			\$ 2,223	
	TR-5412-S-BB-30	Single Face Shelving	30 ^{13/16} "	13 ^{9/16} "	54"	11 ^{1/2} "	4	4			\$ 2,505	
	TR-5412-A-BB-30	Single Face Adder	29 ^{9/16} "	13 ^{9/16} "	54"	11 ^{1/2} "	4	4			\$ 2,239	
	TR-5410-S-BB-36	Single Face Shelving	36 ^{13/16} "	11 ^{9/16} "	54"	9 ^{1/2} "	4	4			\$ 2,417	
	TR-5410-A-BB-36	Single Face Adder	35 ^{9/16} "	11 ^{9/16} "	54"	9 ^{1/2} "	4	4			\$ 2,214	
	TR-5412-S-BB-36	Single Face Shelving	36 ^{13/16} "	13 ^{9/16} "	54"	11 ^{1/2} "	4	4			\$ 2,456	
	TR-5412-A-BB-36	Single Face Adder	35 ^{9/16} "	13 ^{9/16} "	54"	11 ^{1/2} "	4	4			\$ 2,191	
 <p>Model Shown TR-6612-S-BB-36</p>	TR-6610-S-BB-24	Single Face Shelving	24 ^{13/16} "	11 ^{9/16} "	66"	9 ^{1/2} "	4	4			\$ 2,510	
	TR-6610-A-BB-24	Single Face Adder	23 ^{9/16} "	11 ^{9/16} "	66"	9 ^{1/2} "	4	4			\$ 2,246	
	TR-6612-S-BB-24	Single Face Shelving	24 ^{13/16} "	13 ^{9/16} "	66"	11 ^{1/2} "	4	4			\$ 2,535	
	TR-6612-A-BB-24	Single Face Adder	23 ^{9/16} "	13 ^{9/16} "	66"	11 ^{1/2} "	4	4			\$ 2,270	
	TR-6610-S-BB-30	Single Face Shelving	30 ^{13/16} "	11 ^{9/16} "	66"	9 ^{1/2} "	4	4			\$ 2,510	
	TR-6610-A-BB-30	Single Face Adder	29 ^{9/16} "	11 ^{9/16} "	66"	9 ^{1/2} "	4	4			\$ 2,246	
	TR-6612-S-BB-30	Single Face Shelving	30 ^{13/16} "	13 ^{9/16} "	66"	11 ^{1/2} "	4	4			\$ 2,535	
	TR-6612-A-BB-30	Single Face Adder	29 ^{9/16} "	13 ^{9/16} "	66"	11 ^{1/2} "	4	4			\$ 2,270	
	TR-6610-S-BB-36	Single Face Shelving	36 ^{13/16} "	11 ^{9/16} "	66"	9 ^{1/2} "	4	4			\$ 2,448	
	TR-6610-A-BB-36	Single Face Adder	35 ^{9/16} "	11 ^{9/16} "	66"	9 ^{1/2} "	4	4			\$ 2,183	
	TR-6612-S-BB-36	Single Face Shelving	36 ^{13/16} "	13 ^{9/16} "	66"	11 ^{1/2} "	4	4			\$ 2,487	
	TR-6612-A-BB-36	Single Face Adder	35 ^{9/16} "	13 ^{9/16} "	66"	11 ^{1/2} "	4	4			\$ 2,215	



Model Shown
TR-3624-S-BB-36

MODEL NUMBER	PRODUCT	WIDTH	DEPTH	HEIGHT	SHELF DEPTH	# OF SHELVES	# OF OPENINGS	WEIGHT	VOLUME	LIST PRICE
TR-3620-S-BB-24	Double Face Shelving	24 ^{13/16} "	21 ^{1/8} "	36"	9 ^{1/2} "	4	4			\$ 2,136
TR-3620-A-BB-24	Double Face Adder	23 ^{9/16} "	21 ^{1/8} "	36"	9 ^{1/2} "	4	4			\$ 1,955
TR-3624-S-BB-24	Double Face Shelving	24 ^{13/16} "	25 ^{1/8} "	36"	11 ^{1/2} "	4	4			\$ 2,167
TR-3624-A-BB-24	Double Face Adder	23 ^{9/16} "	25 ^{1/8} "	36"	11 ^{1/2} "	4	4			\$ 1,986
TR-3620-S-BB-30	Double Face Shelving	30 ^{13/16} "	21 ^{1/8} "	36"	9 ^{1/2} "	4	4			\$ 2,136
TR-3620-A-BB-30	Double Face Adder	29 ^{9/16} "	21 ^{1/8} "	36"	9 ^{1/2} "	4	4			\$ 1,955
TR-3624-S-BB-30	Double Face Shelving	30 ^{13/16} "	25 ^{1/8} "	36"	11 ^{1/2} "	4	4			\$ 2,167
TR-3624-A-BB-30	Double Face Adder	29 ^{9/16} "	25 ^{1/8} "	36"	11 ^{1/2} "	4	4			\$ 1,986
TR-3620-S-BB-36	Double Face Shelving	36 ^{13/16} "	21 ^{1/8} "	36"	9 ^{1/2} "	4	4			\$ 2,084
TR-3620-A-BB-36	Double Face Adder	35 ^{9/16} "	21 ^{1/8} "	36"	9 ^{1/2} "	4	4			\$ 1,903
TR-3624-S-BB-36	Double Face Shelving	36 ^{13/16} "	25 ^{1/8} "	36"	11 ^{1/2} "	4	4			\$ 2,116
TR-3624-A-BB-36	Double Face Adder	35 ^{9/16} "	25 ^{1/8} "	36"	11 ^{1/2} "	4	4			\$ 1,930



Model Shown
TR-4224-S-BB-36

TR-4220-S-BB-24	Double Face Shelving	24 ^{13/16} "	21 ^{1/8} "	42"	9 ^{1/2} "	6	6			\$ 2,984
TR-4220-A-BB-24	Double Face Adder	23 ^{9/16} "	21 ^{1/8} "	42"	9 ^{1/2} "	6	6			\$ 2,712
TR-4224-S-BB-24	Double Face Shelving	24 ^{13/16} "	25 ^{1/8} "	42"	11 ^{1/2} "	6	6			\$ 3,029
TR-4224-A-BB-24	Double Face Adder	23 ^{9/16} "	25 ^{1/8} "	42"	11 ^{1/2} "	6	6			\$ 2,759
TR-4220-S-BB-30	Double Face Shelving	30 ^{13/16} "	21 ^{1/8} "	42"	9 ^{1/2} "	6	6			\$ 2,984
TR-4220-A-BB-30	Double Face Adder	29 ^{9/16} "	21 ^{1/8} "	42"	9 ^{1/2} "	6	6			\$ 2,712
TR-4224-S-BB-30	Double Face Shelving	30 ^{13/16} "	25 ^{1/8} "	42"	11 ^{1/2} "	6	6			\$ 3,029
TR-4224-A-BB-30	Double Face Adder	29 ^{9/16} "	25 ^{1/8} "	42"	11 ^{1/2} "	6	6			\$ 2,759
TR-4220-S-BB-36	Double Face Shelving	36 ^{13/16} "	21 ^{1/8} "	42"	9 ^{1/2} "	6	6			\$ 2,905
TR-4220-A-BB-36	Double Face Adder	35 ^{9/16} "	21 ^{1/8} "	42"	9 ^{1/2} "	6	6			\$ 2,635
TR-4224-S-BB-36	Double Face Shelving	36 ^{13/16} "	25 ^{1/8} "	42"	11 ^{1/2} "	6	6			\$ 2,953
TR-4224-A-BB-36	Double Face Adder	35 ^{9/16} "	25 ^{1/8} "	42"	11 ^{1/2} "	6	6			\$ 2,674





Model Shown
TR-4824-S-BB-36







TR-4820-S-BB-24	Double Face Shelving	24 ^{13/16} "	21 ^{1/8} "	48"	9 ^{1/2} "	6	6			\$ 3,029
TR-4820-A-BB-24	Double Face Adder	23 ^{9/16} "	21 ^{1/8} "	48"	9 ^{1/2} "	6	6			\$ 2,759
TR-4824-S-BB-24	Double Face Shelving	24 ^{13/16} "	25 ^{1/8} "	48"	11 ^{1/2} "	6	6			\$ 3,085
TR-4824-A-BB-24	Double Face Adder	23 ^{9/16} "	25 ^{1/8} "	48"	11 ^{1/2} "	6	6			\$ 2,798
TR-4820-S-BB-30	Double Face Shelving	30 ^{13/16} "	21 ^{1/8} "	48"	9 ^{1/2} "	6	6			\$ 3,029
TR-4820-A-BB-30	Double Face Adder	29 ^{9/16} "	21 ^{1/8} "	48"	9 ^{1/2} "	6	6			\$ 2,759
TR-4824-S-BB-30	Double Face Shelving	30 ^{13/16} "	25 ^{1/8} "	48"	11 ^{1/2} "	6	6			\$ 3,085
TR-4824-A-BB-30	Double Face Adder	29 ^{9/16} "	25 ^{1/8} "	48"	11 ^{1/2} "	6	6			\$ 2,798
TR-4820-S-BB-36	Double Face Shelving	36 ^{13/16} "	21 ^{1/8} "	48"	9 ^{1/2} "	6	6			\$ 2,953
TR-4820-A-BB-36	Double Face Adder	35 ^{9/16} "	21 ^{1/8} "	48"	9 ^{1/2} "	6	6			\$ 2,674
TR-4824-S-BB-36	Double Face Shelving	36 ^{13/16} "	25 ^{1/8} "	48"	11 ^{1/2} "	6	6			\$ 2,999
TR-4824-A-BB-36	Double Face Adder	35 ^{9/16} "	25 ^{1/8} "	48"	11 ^{1/2} "	6	6			\$ 2,720







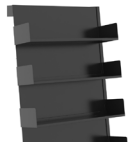

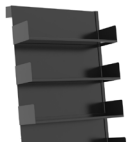
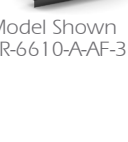
Made of a 1^{1/4}" x 2" metal frame with powder coat paint.





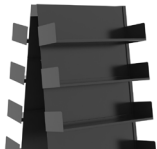

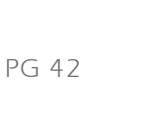

METAL FINISHING: All metal components are thoroughly cleaned and coated electrostatically with an epoxy powder coat paint finish. The metal components are then oven baked and cured for a lasting finish.





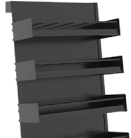

Browser box shelf is 5" high with 6 compartments and 5 removable rods to accommodate various media.



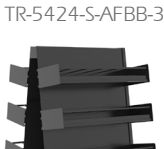

	MODEL NUMBER	PRODUCT	WIDTH	DEPTH	HEIGHT	SHELF DEPTH	# OF SHELVES	# OF OPENINGS	WEIGHT	VOLUME	LIST PRICE	DESCRIPTION
 <p>Model Shown TR-5424-S-BB-36</p>	TR-5420-S-BB-24	Double Face Shelving	24 ^{13/16} "	21 ^{1/8} "	54"	9 ^{1/2} "	8	8			\$ 3,771	<p>Made of a 1^{1/4}" x 2" metal frame with powder coat paint.</p> <p>METAL FINISHING: All metal components are thoroughly cleaned and coated electrostatically with an epoxy powder coat paint finish. The metal components are then oven baked and cured for a lasting finish.</p> <p>Browser box shelf is 5" high with 6 compartments and 5 removable rods to accomodate various media.</p>
	TR-5420-A-BB-24	Double Face Adder	23 ^{9/16} "	21 ^{1/8} "	54"	9 ^{1/2} "	8	8			\$ 3,458	
	TR-5424-S-BB-24	Double Face Shelving	24 ^{13/16} "	25 ^{1/8} "	54"	11 ^{1/2} "	8	8			\$ 3,793	
	TR-5424-A-BB-24	Double Face Adder	23 ^{9/16} "	25 ^{1/8} "	54"	11 ^{1/2} "	8	8			\$ 3,498	
	TR-5420-S-BB-30	Double Face Shelving	30 ^{13/16} "	21 ^{1/8} "	54"	9 ^{1/2} "	8	8			\$ 3,771	
	TR-5420-A-BB-30	Double Face Adder	29 ^{9/16} "	21 ^{1/8} "	54"	9 ^{1/2} "	8	8			\$ 3,458	
	TR-5424-S-BB-30	Double Face Shelving	30 ^{13/16} "	25 ^{1/8} "	54"	11 ^{1/2} "	8	8			\$ 3,793	
	TR-5424-A-BB-30	Double Face Adder	29 ^{9/16} "	25 ^{1/8} "	54"	11 ^{1/2} "	8	8			\$ 3,498	
	TR-5420-S-BB-36	Double Face Shelving	36 ^{13/16} "	21 ^{1/8} "	54"	9 ^{1/2} "	8	8			\$ 3,644	
	TR-5420-A-BB-36	Double Face Adder	35 ^{9/16} "	21 ^{1/8} "	54"	9 ^{1/2} "	8	8			\$ 3,342	
	TR-5424-S-BB-36	Double Face Shelving	36 ^{13/16} "	25 ^{1/8} "	54"	11 ^{1/2} "	8	8			\$ 3,701	
	TR-5424-A-BB-36	Double Face Adder	35 ^{9/16} "	25 ^{1/8} "	54"	11 ^{1/2} "	8	8			\$ 3,390	
 <p>Model Shown TR-6624-S-BB-36</p>	TR-6620-S-BB-24	Double Face Shelving	24 ^{13/16} "	21 ^{1/8} "	66"	9 ^{1/2} "	8	8			\$ 3,817	
	TR-6620-A-BB-24	Double Face Adder	23 ^{9/16} "	21 ^{1/8} "	66"	9 ^{1/2} "	8	8			\$ 3,505	
	TR-6624-S-BB-24	Double Face Shelving	24 ^{13/16} "	25 ^{1/8} "	66"	11 ^{1/2} "	8	8			\$ 3,848	
	TR-6624-A-BB-24	Double Face Adder	23 ^{9/16} "	25 ^{1/8} "	66"	11 ^{1/2} "	8	8			\$ 3,536	
	TR-6620-S-BB-30	Double Face Shelving	30 ^{13/16} "	21 ^{1/8} "	66"	9 ^{1/2} "	8	8			\$ 3,817	
	TR-6620-A-BB-30	Double Face Adder	29 ^{9/16} "	21 ^{1/8} "	66"	9 ^{1/2} "	8	8			\$ 3,505	
	TR-6624-S-BB-30	Double Face Shelving	30 ^{13/16} "	25 ^{1/8} "	66"	11 ^{1/2} "	8	8			\$ 3,848	
	TR-6624-A-BB-30	Double Face Adder	29 ^{9/16} "	25 ^{1/8} "	66"	11 ^{1/2} "	8	8			\$ 3,536	
	TR-6620-S-BB-36	Double Face Shelving	36 ^{13/16} "	21 ^{1/8} "	66"	9 ^{1/2} "	8	8			\$ 3,693	
	TR-6620-A-BB-36	Double Face Adder	35 ^{9/16} "	21 ^{1/8} "	66"	9 ^{1/2} "	8	8			\$ 3,381	
	TR-6624-S-BB-36	Double Face Shelving	36 ^{13/16} "	25 ^{1/8} "	66"	11 ^{1/2} "	8	8			\$ 3,747	
	TR-6624-A-BB-36	Double Face Adder	35 ^{9/16} "	25 ^{1/8} "	66"	11 ^{1/2} "	8	8			\$ 3,436	

	MODEL NUMBER	PRODUCT	WIDTH	DEPTH	HEIGHT	SHELF DEPTH	# OF SHELVES	# OF OPENINGS	WEIGHT	VOLUME	LIST PRICE	DESCRIPTION
 Model Shown TR-4210-S-AF-30	TR-4210-S-AF-24	Single Face Shelving	24 ⁷ / ₈ "	19"	42"	9 ¹ / ₂ "	3	3			\$ 1,991	Made of a 1 ¹ / ₄ " x 2" metal frame with powder coat paint. METAL FINISHING: All metal components are thoroughly cleaned and coated electrostatically with an epoxy powder coat paint finish. The metal components are then oven baked and cured for a lasting finish.
	TR-4210-A-AF-24	Single Face Adder	23 ⁵ / ₈ "	19"	42"	9 ¹ / ₂ "	3	3			\$ 1,713	
	TR-4212-S-AF-24	Single Face Shelving	24 ⁷ / ₈ "	21"	42"	11 ¹ / ₂ "	3	3			\$ 2,026	
	TR-4212-A-AF-24	Single Face Adder	23 ⁵ / ₈ "	21"	42"	11 ¹ / ₂ "	3	3			\$ 1,749	
 Model Shown TR-4210-S-AF-30	TR-4210-S-AF-30	Single Face Shelving	30 ⁷ / ₈ "	19"	42"	9 ¹ / ₂ "	3	3			\$ 1,991	
	TR-4210-A-AF-30	Single Face Adder	29 ⁵ / ₈ "	19"	42"	9 ¹ / ₂ "	3	3			\$ 1,713	
	TR-4212-S-AF-30	Single Face Shelving	30 ⁷ / ₈ "	21"	42"	11 ¹ / ₂ "	3	3			\$ 2,026	
	TR-4212-A-AF-30	Single Face Adder	29 ⁵ / ₈ "	21"	42"	11 ¹ / ₂ "	3	3			\$ 1,749	
 Model Shown TR-4210-S-AF-30	TR-4210-S-AF-36	Single Face Shelving	36 ⁷ / ₈ "	19"	42"	9 ¹ / ₂ "	3	3			\$ 1,932	
	TR-4210-A-AF-36	Single Face Adder	35 ⁵ / ₈ "	19"	42"	9 ¹ / ₂ "	3	3			\$ 1,655	
	TR-4212-S-AF-36	Single Face Shelving	36 ⁷ / ₈ "	21"	42"	11 ¹ / ₂ "	3	3			\$ 1,968	
	TR-4212-A-AF-36	Single Face Adder	35 ⁵ / ₈ "	21"	42"	11 ¹ / ₂ "	3	3			\$ 1,690	
 Model Shown TR-5410-S-AF-30	TR-5410-S-AF-24	Single Face Shelving	24 ⁷ / ₈ "	20 ³ / ₄ "	54"	9 ¹ / ₂ "	4	4			\$ 2,184	
	TR-5410-A-AF-24	Single Face Adder	23 ⁵ / ₈ "	20 ³ / ₄ "	54"	9 ¹ / ₂ "	4	4			\$ 1,907	
	TR-5412-S-AF-24	Single Face Shelving	24 ⁷ / ₈ "	22 ³ / ₄ "	54"	11 ¹ / ₂ "	4	4			\$ 2,220	
	TR-5412-A-AF-24	Single Face Adder	23 ⁵ / ₈ "	22 ³ / ₄ "	54"	11 ¹ / ₂ "	4	4			\$ 1,942	
 Model Shown TR-5410-S-AF-30	TR-5410-S-AF-30	Single Face Shelving	30 ⁷ / ₈ "	20 ³ / ₄ "	54"	9 ¹ / ₂ "	4	4			\$ 2,184	
	TR-5410-A-AF-30	Single Face Adder	29 ⁵ / ₈ "	20 ³ / ₄ "	54"	9 ¹ / ₂ "	4	4			\$ 1,907	
	TR-5412-S-AF-30	Single Face Shelving	30 ⁷ / ₈ "	22 ³ / ₄ "	54"	11 ¹ / ₂ "	4	4			\$ 2,220	
	TR-5412-A-AF-30	Single Face Adder	29 ⁵ / ₈ "	22 ³ / ₄ "	54"	11 ¹ / ₂ "	4	4			\$ 1,942	
 Model Shown TR-5410-S-AF-30	TR-5410-S-AF-36	Single Face Shelving	36 ⁷ / ₈ "	20 ³ / ₄ "	54"	9 ¹ / ₂ "	4	4			\$ 2,125	
	TR-5410-A-AF-36	Single Face Adder	35 ⁵ / ₈ "	20 ³ / ₄ "	54"	9 ¹ / ₂ "	4	4			\$ 1,848	
	TR-5412-S-AF-36	Single Face Shelving	36 ⁷ / ₈ "	22 ³ / ₄ "	54"	11 ¹ / ₂ "	4	4			\$ 2,161	
	TR-5412-A-AF-36	Single Face Adder	35 ⁵ / ₈ "	22 ³ / ₄ "	54"	11 ¹ / ₂ "	4	4			\$ 1,884	
 Model Shown TR-6610-S-AF-30	TR-6610-S-AF-24	Single Face Shelving	24 ⁷ / ₈ "	22 ¹ / ₂ "	66"	9 ¹ / ₂ "	5	5			\$ 2,383	
	TR-6610-A-AF-24	Single Face Adder	23 ⁵ / ₈ "	22 ¹ / ₂ "	66"	9 ¹ / ₂ "	5	5			\$ 2,106	
	TR-6612-S-AF-24	Single Face Shelving	24 ⁷ / ₈ "	24 ¹ / ₂ "	66"	11 ¹ / ₂ "	5	5			\$ 2,418	
	TR-6612-A-AF-24	Single Face Adder	23 ⁵ / ₈ "	24 ¹ / ₂ "	66"	11 ¹ / ₂ "	5	5			\$ 2,141	
 Model Shown TR-6610-S-AF-30	TR-6610-S-AF-30	Single Face Shelving	30 ⁷ / ₈ "	22 ¹ / ₂ "	66"	9 ¹ / ₂ "	5	5			\$ 2,383	
	TR-6610-A-AF-30	Single Face Adder	29 ⁵ / ₈ "	22 ¹ / ₂ "	66"	9 ¹ / ₂ "	5	5			\$ 2,106	
	TR-6612-S-AF-30	Single Face Shelving	30 ⁷ / ₈ "	24 ¹ / ₂ "	66"	11 ¹ / ₂ "	5	5			\$ 2,418	
	TR-6612-A-AF-30	Single Face Adder	29 ⁵ / ₈ "	24 ¹ / ₂ "	66"	11 ¹ / ₂ "	5	5			\$ 2,141	
 Model Shown TR-6610-S-AF-30	TR-6610-S-AF-36	Single Face Shelving	36 ⁷ / ₈ "	22 ¹ / ₂ "	66"	9 ¹ / ₂ "	5	5			\$ 2,324	
	TR-6610-A-AF-36	Single Face Adder	35 ⁵ / ₈ "	22 ¹ / ₂ "	66"	9 ¹ / ₂ "	5	5			\$ 2,047	
	TR-6612-S-AF-36	Single Face Shelving	36 ⁷ / ₈ "	24 ¹ / ₂ "	66"	11 ¹ / ₂ "	5	5			\$ 2,360	
	TR-6612-A-AF-36	Single Face Adder	35 ⁵ / ₈ "	24 ¹ / ₂ "	66"	11 ¹ / ₂ "	5	5			\$ 2,083	

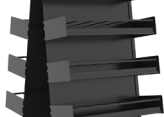
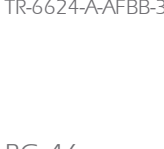



	MODEL NUMBER	PRODUCT	WIDTH	DEPTH	HEIGHT	SHELF DEPTH	# OF SHELVES	# OF OPENINGS	WEIGHT	VOLUME	LIST PRICE	DESCRIPTION
 Model Shown TR-4220-S-AF-30	TR-4220-S-AF-24	Double Face Shelving	24 ⁷ / ₈ "	34"	42"	9 ¹ / ₂ "	6	6			\$ 3,011	Made of a 1 ¹ / ₄ " x 2" metal frame with powder coat paint. METAL FINISHING: All metal components are thoroughly cleaned and coated electrostatically with an epoxy powder coat paint finish. The metal components are then oven baked and cured for a lasting finish.
	TR-4220-A-AF-24	Double Face Adder	23 ⁵ / ₈ "	34"	42"	9 ¹ / ₂ "	6	6			\$ 2,675	
	TR-4224-S-AF-24	Double Face Shelving	24 ⁷ / ₈ "	38"	42"	11 ¹ / ₂ "	6	6			\$ 3,077	
	TR-4224-A-AF-24	Double Face Adder	23 ⁵ / ₈ "	38"	42"	11 ¹ / ₂ "	6	6			\$ 2,742	
 Model Shown TR-4220-S-AF-30	TR-4220-S-AF-30	Double Face Shelving	30 ⁷ / ₈ "	34"	42"	9 ¹ / ₂ "	6	6			\$ 3,011	
	TR-4220-A-AF-30	Double Face Adder	29 ⁵ / ₈ "	34"	42"	9 ¹ / ₂ "	6	6			\$ 2,675	
	TR-4224-S-AF-30	Double Face Shelving	30 ⁷ / ₈ "	38"	42"	11 ¹ / ₂ "	6	6			\$ 3,077	
	TR-4224-A-AF-30	Double Face Adder	29 ⁵ / ₈ "	38"	42"	11 ¹ / ₂ "	6	6			\$ 2,742	
 Model Shown TR-4220-S-AF-30	TR-4220-S-AF-36	Double Face Shelving	36 ⁷ / ₈ "	34"	42"	9 ¹ / ₂ "	6	6			\$ 2,899	
	TR-4220-A-AF-36	Double Face Adder	35 ⁵ / ₈ "	34"	42"	9 ¹ / ₂ "	6	6			\$ 2,563	
	TR-4224-S-AF-36	Double Face Shelving	36 ⁷ / ₈ "	38"	42"	11 ¹ / ₂ "	6	6			\$ 2,966	
	TR-4224-A-AF-36	Double Face Adder	35 ⁵ / ₈ "	38"	42"	11 ¹ / ₂ "	6	6			\$ 2,630	
 Model Shown TR-5420-S-AF-30	TR-5420-S-AF-24	Double Face Shelving	24 ⁷ / ₈ "	37 ¹ / ₂ "	54"	9 ¹ / ₂ "	8	8			\$ 3,359	
	TR-5420-A-AF-24	Double Face Adder	23 ⁵ / ₈ "	37 ¹ / ₂ "	54"	9 ¹ / ₂ "	8	8			\$ 3,023	
	TR-5424-S-AF-24	Double Face Shelving	24 ⁷ / ₈ "	41 ¹ / ₂ "	54"	11 ¹ / ₂ "	8	8			\$ 3,426	
	TR-5424-A-AF-24	Double Face Adder	23 ⁵ / ₈ "	41 ¹ / ₂ "	54"	11 ¹ / ₂ "	8	8			\$ 3,090	
 Model Shown TR-5420-S-AF-30	TR-5420-S-AF-30	Double Face Shelving	30 ⁷ / ₈ "	37 ¹ / ₂ "	54"	9 ¹ / ₂ "	8	8			\$ 3,359	
	TR-5420-A-AF-30	Double Face Adder	29 ⁵ / ₈ "	37 ¹ / ₂ "	54"	9 ¹ / ₂ "	8	8			\$ 3,023	
	TR-5424-S-AF-30	Double Face Shelving	30 ⁷ / ₈ "	41 ¹ / ₂ "	54"	11 ¹ / ₂ "	8	8			\$ 3,426	
	TR-5424-A-AF-30	Double Face Adder	29 ⁵ / ₈ "	41 ¹ / ₂ "	54"	11 ¹ / ₂ "	8	8			\$ 3,090	
 Model Shown TR-5420-S-AF-30	TR-5420-S-AF-36	Double Face Shelving	36 ⁷ / ₈ "	37 ¹ / ₂ "	54"	9 ¹ / ₂ "	8	8			\$ 3,248	
	TR-5420-A-AF-36	Double Face Adder	35 ⁵ / ₈ "	37 ¹ / ₂ "	54"	9 ¹ / ₂ "	8	8			\$ 2,912	
	TR-5424-S-AF-36	Double Face Shelving	36 ⁷ / ₈ "	41 ¹ / ₂ "	54"	11 ¹ / ₂ "	8	8			\$ 3,314	
	TR-5424-A-AF-36	Double Face Adder	35 ⁵ / ₈ "	41 ¹ / ₂ "	54"	11 ¹ / ₂ "	8	8			\$ 2,978	
 Model Shown TR-6620-S-AF-30	TR-6620-S-AF-24	Double Face Shelving	24 ⁷ / ₈ "	40 ³ / ₄ "	66"	9 ¹ / ₂ "	10	10			\$ 3,743	
	TR-6620-A-AF-24	Double Face Adder	23 ⁵ / ₈ "	40 ³ / ₄ "	66"	9 ¹ / ₂ "	10	10			\$ 3,407	
	TR-6624-S-AF-24	Double Face Shelving	24 ⁷ / ₈ "	44 ³ / ₄ "	66"	11 ¹ / ₂ "	10	10			\$ 3,810	
	TR-6624-A-AF-24	Double Face Adder	23 ⁵ / ₈ "	44 ³ / ₄ "	66"	11 ¹ / ₂ "	10	10			\$ 3,474	
 Model Shown TR-6620-S-AF-30	TR-6620-S-AF-30	Double Face Shelving	30 ⁷ / ₈ "	40 ³ / ₄ "	66"	9 ¹ / ₂ "	10	10			\$ 3,743	
	TR-6620-A-AF-30	Double Face Adder	29 ⁵ / ₈ "	40 ³ / ₄ "	66"	9 ¹ / ₂ "	10	10			\$ 3,407	
	TR-6624-S-AF-30	Double Face Shelving	30 ⁷ / ₈ "	44 ³ / ₄ "	66"	11 ¹ / ₂ "	10	10			\$ 3,810	
	TR-6624-A-AF-30	Double Face Adder	29 ⁵ / ₈ "	44 ³ / ₄ "	66"	11 ¹ / ₂ "	10	10			\$ 3,474	
 Model Shown TR-6620-S-AF-30	TR-6620-S-AF-36	Double Face Shelving	36 ⁷ / ₈ "	40 ³ / ₄ "	66"	9 ¹ / ₂ "	10	10			\$ 3,632	
	TR-6620-A-AF-36	Double Face Adder	35 ⁵ / ₈ "	40 ³ / ₄ "	66"	9 ¹ / ₂ "	10	10			\$ 3,296	
	TR-6624-S-AF-36	Double Face Shelving	36 ⁷ / ₈ "	44 ³ / ₄ "	66"	11 ¹ / ₂ "	10	10			\$ 3,698	
	TR-6624-A-AF-36	Double Face Adder	35 ⁵ / ₈ "	44 ³ / ₄ "	66"	11 ¹ / ₂ "	10	10			\$ 3,363	

	MODEL NUMBER	PRODUCT	WIDTH	DEPTH	HEIGHT	SHELF DEPTH	# OF SHELVES	# OF OPENINGS	WEIGHT	VOLUME	LIST PRICE	DESCRIPTION
	TR-4210-S-AFBB-24	Single Face Shelving	24 ⁷ / ₈ "	19"	42"	9 ¹ / ₂ "	3	3			\$ 2,820	<p>Made of a 1¹/₄" x 2" metal frame with powder coat paint.</p> <p>METAL FINISHING: All metal components are thoroughly cleaned and coated electrostatically with an epoxy powder coat paint finish. The metal components are then oven baked and cured for a lasting finish.</p> <p>Browser box shelf is 5" high with 6 compartments and 5 removable rods to accommodate various media.</p>
	TR-4210-A-AFBB-24	Single Face Adder	23 ⁵ / ₈ "	19"	42"	9 ¹ / ₂ "	3	3			\$ 2,484	
	TR-4212-S-AFBB-24	Single Face Shelving	24 ⁷ / ₈ "	21"	42"	11 ¹ / ₂ "	3	3			\$ 2,887	
	TR-4212-A-AFBB-24	Single Face Adder	23 ⁵ / ₈ "	21"	42"	11 ¹ / ₂ "	3	3			\$ 2,551	
	TR-4210-S-AFBB-30	Single Face Shelving	30 ⁷ / ₈ "	19"	42"	9 ¹ / ₂ "	3	3			\$ 2,820	
	TR-4210-A-AFBB-30	Single Face Adder	29 ⁵ / ₈ "	19"	42"	9 ¹ / ₂ "	3	3			\$ 2,484	
	TR-4212-S-AFBB-30	Single Face Shelving	30 ⁷ / ₈ "	21"	42"	11 ¹ / ₂ "	3	3			\$ 2,887	
	TR-4212-A-AFBB-30	Single Face Adder	29 ⁵ / ₈ "	21"	42"	11 ¹ / ₂ "	3	3			\$ 2,551	
	TR-4210-S-AFBB-36	Single Face Shelving	36 ⁷ / ₈ "	19"	42"	9 ¹ / ₂ "	3	3			\$ 2,708	
	TR-4210-A-AFBB-36	Single Face Adder	35 ⁵ / ₈ "	19"	42"	9 ¹ / ₂ "	3	3			\$ 2,372	
	TR-4212-S-AFBB-36	Single Face Shelving	36 ⁷ / ₈ "	21"	42"	11 ¹ / ₂ "	3	3			\$ 2,775	
	TR-4212-A-AFBB-36	Single Face Adder	35 ⁵ / ₈ "	21"	42"	11 ¹ / ₂ "	3	3			\$ 2,439	
	TR-5410-S-AFBB-24	Single Face Shelving	24 ⁷ / ₈ "	20 ³ / ₄ "	54"	9 ¹ / ₂ "	4	4			\$ 2,850	
	TR-5410-A-AFBB-24	Single Face Adder	23 ⁵ / ₈ "	20 ³ / ₄ "	54"	9 ¹ / ₂ "	4	4			\$ 2,514	
	TR-5412-S-AFBB-24	Single Face Shelving	24 ⁷ / ₈ "	22 ³ / ₄ "	54"	11 ¹ / ₂ "	4	4			\$ 2,916	
	TR-5412-A-AFBB-24	Single Face Adder	23 ⁵ / ₈ "	22 ³ / ₄ "	54"	11 ¹ / ₂ "	4	4			\$ 2,581	
	TR-5410-S-AFBB-30	Single Face Shelving	30 ⁷ / ₈ "	20 ³ / ₄ "	54"	9 ¹ / ₂ "	4	4			\$ 2,850	
	TR-5410-A-AFBB-30	Single Face Adder	29 ⁵ / ₈ "	20 ³ / ₄ "	54"	9 ¹ / ₂ "	4	4			\$ 2,514	
	TR-5412-S-AFBB-30	Single Face Shelving	30 ⁷ / ₈ "	22 ³ / ₄ "	54"	11 ¹ / ₂ "	4	4			\$ 2,916	
	TR-5412-A-AFBB-30	Single Face Adder	29 ⁵ / ₈ "	22 ³ / ₄ "	54"	11 ¹ / ₂ "	4	4			\$ 2,581	
	TR-5410-S-AFBB-36	Single Face Shelving	36 ⁷ / ₈ "	20 ³ / ₄ "	54"	9 ¹ / ₂ "	4	4			\$ 2,738	
	TR-5410-A-AFBB-36	Single Face Adder	35 ⁵ / ₈ "	20 ³ / ₄ "	54"	9 ¹ / ₂ "	4	4			\$ 2,402	
	TR-5412-S-AFBB-36	Single Face Shelving	36 ⁷ / ₈ "	22 ³ / ₄ "	54"	11 ¹ / ₂ "	4	4			\$ 2,805	
	TR-5412-A-AFBB-36	Single Face Adder	35 ⁵ / ₈ "	22 ³ / ₄ "	54"	11 ¹ / ₂ "	4	4			\$ 2,469	
	TR-6610-S-AFBB-24	Single Face Shelving	24 ⁷ / ₈ "	22 ¹ / ₂ "	66"	9 ¹ / ₂ "	5	5			\$ 3,310	
	TR-6610-A-AFBB-24	Single Face Adder	23 ⁵ / ₈ "	22 ¹ / ₂ "	66"	9 ¹ / ₂ "	5	5			\$ 2,974	
	TR-6612-S-AFBB-24	Single Face Shelving	24 ⁷ / ₈ "	24 ¹ / ₂ "	66"	11 ¹ / ₂ "	5	5			\$ 3,376	
	TR-6612-A-AFBB-24	Single Face Adder	23 ⁵ / ₈ "	24 ¹ / ₂ "	66"	11 ¹ / ₂ "	5	5			\$ 3,041	
	TR-6610-S-AFBB-30	Single Face Shelving	30 ⁷ / ₈ "	22 ¹ / ₂ "	66"	9 ¹ / ₂ "	5	5			\$ 3,310	
	TR-6610-A-AFBB-30	Single Face Adder	29 ⁵ / ₈ "	22 ¹ / ₂ "	66"	9 ¹ / ₂ "	5	5			\$ 2,974	
	TR-6612-S-AFBB-30	Single Face Shelving	30 ⁷ / ₈ "	24 ¹ / ₂ "	66"	11 ¹ / ₂ "	5	5			\$ 3,376	
	TR-6612-A-AFBB-30	Single Face Adder	29 ⁵ / ₈ "	24 ¹ / ₂ "	66"	11 ¹ / ₂ "	5	5			\$ 3,041	
	TR-6610-S-AFBB-36	Single Face Shelving	36 ⁷ / ₈ "	22 ¹ / ₂ "	66"	9 ¹ / ₂ "	5	5			\$ 3,198	
	TR-6610-A-AFBB-36	Single Face Adder	35 ⁵ / ₈ "	22 ¹ / ₂ "	66"	9 ¹ / ₂ "	5	5			\$ 2,862	
	TR-6612-S-AFBB-36	Single Face Shelving	36 ⁷ / ₈ "	24 ¹ / ₂ "	66"	11 ¹ / ₂ "	5	5			\$ 3,265	
	TR-6612-A-AFBB-36	Single Face Adder	35 ⁵ / ₈ "	24 ¹ / ₂ "	66"	11 ¹ / ₂ "	5	5			\$ 2,929	

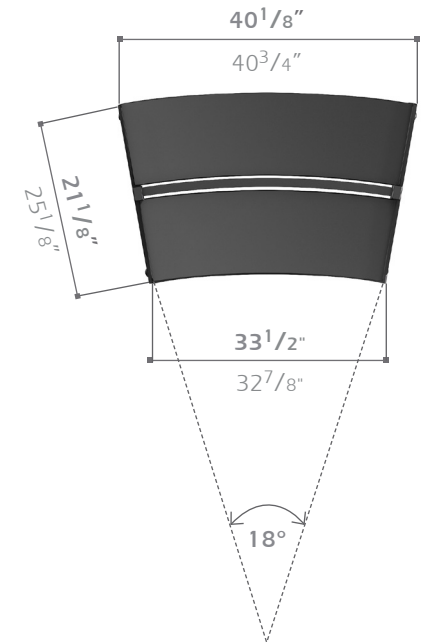



	MODEL NUMBER	PRODUCT	WIDTH	DEPTH	HEIGHT	SHELF DEPTH	# OF SHELVES	# OF OPENINGS	WEIGHT	VOLUME	LIST PRICE	DESCRIPTION
 Model Shown TR-4224-S-AFBB-30	TR-4220-S-AFBB-24	Double Face Shelving	24 ⁷ / ₈ "	34"	42"	9 ¹ / ₂ "	6	6			\$ 3,744	Made of a 1 ¹ / ₄ " x 2" metal frame with powder coat paint. METAL FINISHING: All metal components are thoroughly cleaned and coated electrostatically with an epoxy powder coat paint finish. The metal components are then oven baked and cured for a lasting finish. Browser box shelf is 5" high with 6 compartments and 5 removable rods to accommodate various media.
	TR-4220-A-AFBB-24	Double Face Adder	23 ⁵ / ₈ "	34"	42"	9 ¹ / ₂ "	6	6			\$ 3,409	
	TR-4224-S-AFBB-24	Double Face Shelving	24 ⁷ / ₈ "	38"	42"	11 ¹ / ₂ "	6	6			\$ 3,811	
	TR-4224-A-AFBB-24	Double Face Adder	23 ⁵ / ₈ "	38"	42"	11 ¹ / ₂ "	6	6			\$ 3,475	
 Model Shown TR-4224-S-AFBB-30	TR-4220-S-AFBB-30	Double Face Shelving	30 ⁷ / ₈ "	34"	42"	9 ¹ / ₂ "	6	6			\$ 3,744	
	TR-4220-A-AFBB-30	Double Face Adder	29 ⁵ / ₈ "	34"	42"	9 ¹ / ₂ "	6	6			\$ 3,409	
	TR-4224-S-AFBB-30	Double Face Shelving	30 ⁷ / ₈ "	38"	42"	11 ¹ / ₂ "	6	6			\$ 3,811	
	TR-4224-A-AFBB-30	Double Face Adder	29 ⁵ / ₈ "	38"	42"	11 ¹ / ₂ "	6	6			\$ 3,475	
 Model Shown TR-4224-A-AFBB-30	TR-4220-S-AFBB-36	Double Face Shelving	36 ⁷ / ₈ "	34"	42"	9 ¹ / ₂ "	6	6			\$ 3,633	
	TR-4220-A-AFBB-36	Double Face Adder	35 ⁵ / ₈ "	34"	42"	9 ¹ / ₂ "	6	6			\$ 3,297	
	TR-4224-S-AFBB-36	Double Face Shelving	36 ⁷ / ₈ "	38"	42"	11 ¹ / ₂ "	6	6			\$ 3,700	
	TR-4224-A-AFBB-36	Double Face Adder	35 ⁵ / ₈ "	38"	42"	11 ¹ / ₂ "	6	6			\$ 3,364	
 Model Shown TR-5424-S-AFBB-30	TR-5420-S-AFBB-24	Double Face Shelving	24 ⁷ / ₈ "	37 ¹ / ₂ "	54"	9 ¹ / ₂ "	8	8			\$ 4,224	
	TR-5420-A-AFBB-24	Double Face Adder	23 ⁵ / ₈ "	37 ¹ / ₂ "	54"	9 ¹ / ₂ "	8	8			\$ 4	
	TR-5424-S-AFBB-24	Double Face Shelving	24 ⁷ / ₈ "	41 ¹ / ₂ "	54"	11 ¹ / ₂ "	8	8			\$ 4,291	
	TR-5424-A-AFBB-24	Double Face Adder	23 ⁵ / ₈ "	41 ¹ / ₂ "	54"	11 ¹ / ₂ "	8	8			\$ 3,955	
 Model Shown TR-5424-S-AFBB-30	TR-5420-S-AFBB-30	Double Face Shelving	30 ⁷ / ₈ "	37 ¹ / ₂ "	54"	9 ¹ / ₂ "	8	8			\$ 4,224	
	TR-5420-A-AFBB-30	Double Face Adder	29 ⁵ / ₈ "	37 ¹ / ₂ "	54"	9 ¹ / ₂ "	8	8			\$ 4	
	TR-5424-S-AFBB-30	Double Face Shelving	30 ⁷ / ₈ "	41 ¹ / ₂ "	54"	11 ¹ / ₂ "	8	8			\$ 4,291	
	TR-5424-A-AFBB-30	Double Face Adder	29 ⁵ / ₈ "	41 ¹ / ₂ "	54"	11 ¹ / ₂ "	8	8			\$ 3,955	
 Model Shown TR-5424-A-AFBB-30	TR-5420-S-AFBB-36	Double Face Shelving	36 ⁷ / ₈ "	37 ¹ / ₂ "	54"	9 ¹ / ₂ "	8	8			\$ 4,112	
	TR-5420-A-AFBB-36	Double Face Adder	35 ⁵ / ₈ "	37 ¹ / ₂ "	54"	9 ¹ / ₂ "	8	8			\$ 3,777	
	TR-5424-S-AFBB-36	Double Face Shelving	36 ⁷ / ₈ "	41 ¹ / ₂ "	54"	11 ¹ / ₂ "	8	8			\$ 4,179	
	TR-5424-A-AFBB-36	Double Face Adder	35 ⁵ / ₈ "	41 ¹ / ₂ "	54"	11 ¹ / ₂ "	8	8			\$ 3,843	
 Model Shown TR-6624-S-AFBB-30	TR-6620-S-AFBB-24	Double Face Shelving	24 ⁷ / ₈ "	40 ³ / ₄ "	66"	9 ¹ / ₂ "	10	10			\$ 4,928	
	TR-6620-A-AFBB-24	Double Face Adder	23 ⁵ / ₈ "	40 ³ / ₄ "	66"	9 ¹ / ₂ "	10	10			\$ 4,592	
	TR-6624-S-AFBB-24	Double Face Shelving	24 ⁷ / ₈ "	44 ³ / ₄ "	66"	11 ¹ / ₂ "	10	10			\$ 4,994	
	TR-6624-A-AFBB-24	Double Face Adder	23 ⁵ / ₈ "	44 ³ / ₄ "	66"	11 ¹ / ₂ "	10	10			\$ 4,659	
 Model Shown TR-6624-S-AFBB-30	TR-6620-S-AFBB-30	Double Face Shelving	30 ⁷ / ₈ "	40 ³ / ₄ "	66"	9 ¹ / ₂ "	10	10			\$ 4,928	
	TR-6620-A-AFBB-30	Double Face Adder	29 ⁵ / ₈ "	40 ³ / ₄ "	66"	9 ¹ / ₂ "	10	10			\$ 4,592	
	TR-6624-S-AFBB-30	Double Face Shelving	30 ⁷ / ₈ "	44 ³ / ₄ "	66"	11 ¹ / ₂ "	10	10			\$ 4,994	
	TR-6624-A-AFBB-30	Double Face Adder	29 ⁵ / ₈ "	44 ³ / ₄ "	66"	11 ¹ / ₂ "	10	10			\$ 4,659	
 Model Shown TR-6624-A-AFBB-30	TR-6620-S-AFBB-36	Double Face Shelving	36 ⁷ / ₈ "	40 ³ / ₄ "	66"	9 ¹ / ₂ "	10	10			\$ 4,816	
	TR-6620-A-AFBB-36	Double Face Adder	35 ⁵ / ₈ "	40 ³ / ₄ "	66"	9 ¹ / ₂ "	10	10			\$ 4,480	
	TR-6624-S-AFBB-36	Double Face Shelving	36 ⁷ / ₈ "	44 ³ / ₄ "	66"	11 ¹ / ₂ "	10	10			\$ 4,883	
	TR-6624-A-AFBB-36	Double Face Adder	35 ⁵ / ₈ "	44 ³ / ₄ "	66"	11 ¹ / ₂ "	10	10			\$ 4,547	

	MODEL NUMBER	PRODUCT	WIDTH	DEPTH	HEIGHT	SHELF DEPTH	# OF SHELVES	# OF OPENINGS	WEIGHT	VOLUME	LIST PRICE	DESCRIPTION
 <p>Model Shown TR-CV-3624-S-18-36</p>	TR-CV-3620-S-18-36	Double Face Shelving	36 ¹³ / ₁₆ "	21 ¹ / ₈ "	36"	9 ¹ / ₂ "	4	4			\$ 2,041	<p>Made of a 1¹/₄" x 2" metal frame with powder coat paint.</p> <p>METAL FINISHING: All metal components are thoroughly cleaned and coated electrostatically with an epoxy powder coat paint finish. The metal components are then oven baked and cured for a lasting finish.</p> <p>Curved metal shelf with a 1¹/₄" high book stop back edge.</p>
	TR-CV-3620-A-18-36	Double Face Adder	35 ⁹ / ₁₆ "	21 ¹ / ₈ "	36"	9 ¹ / ₂ "	4	4			\$ 1,868	
	TR-CV-3624-S-18-36	Double Face Shelving	36 ¹³ / ₁₆ "	25 ¹ / ₈ "	36"	11 ¹ / ₂ "	4	4			\$ 2,070	
	TR-CV-3624-A-18-36	Double Face Adder	35 ⁹ / ₁₆ "	25 ¹ / ₈ "	36"	11 ¹ / ₂ "	4	4			\$ 1,899	
 <p>Model Shown TR-CV-4224-S-18-36</p>	TR-CV-4220-S-18-36	Double Face Shelving	36 ¹³ / ₁₆ "	21 ¹ / ₈ "	42"	9 ¹ / ₂ "	6	6			\$ 2,851	
	TR-CV-4220-A-18-36	Double Face Adder	35 ⁹ / ₁₆ "	21 ¹ / ₈ "	42"	9 ¹ / ₂ "	6	6			\$ 2,591	
	TR-CV-4224-S-18-36	Double Face Shelving	36 ¹³ / ₁₆ "	25 ¹ / ₈ "	42"	11 ¹ / ₂ "	6	6			\$ 2,896	
	TR-CV-4224-A-18-36	Double Face Adder	35 ⁹ / ₁₆ "	25 ¹ / ₈ "	42"	11 ¹ / ₂ "	6	6			\$ 2,637	
 <p>Model Shown TR-CV-4824-S-18-36</p>	TR-CV-4820-S-18-36	Double Face Shelving	36 ¹³ / ₁₆ "	21 ¹ / ₈ "	48"	9 ¹ / ₂ "	6	6			\$ 2,895	
	TR-CV-4820-A-18-36	Double Face Adder	35 ⁹ / ₁₆ "	21 ¹ / ₈ "	48"	9 ¹ / ₂ "	6	6			\$ 2,636	
	TR-CV-4824-S-18-36	Double Face Shelving	36 ¹³ / ₁₆ "	25 ¹ / ₈ "	48"	11 ¹ / ₂ "	6	6			\$ 2,947	
	TR-CV-4824-A-18-36	Double Face Adder	35 ⁹ / ₁₆ "	25 ¹ / ₈ "	48"	11 ¹ / ₂ "	6	6			\$ 2,674	
 <p>Model Shown TR-CV-5424-S-18-36</p>	TR-CV-5420-S-18-36	Double Face Shelving	36 ¹³ / ₁₆ "	21 ¹ / ₈ "	54"	9 ¹ / ₂ "	8	8			\$ 3,603	
	TR-CV-5420-A-18-36	Double Face Adder	35 ⁹ / ₁₆ "	21 ¹ / ₈ "	54"	9 ¹ / ₂ "	8	8			\$ 3,304	
	TR-CV-5424-S-18-36	Double Face Shelving	36 ¹³ / ₁₆ "	25 ¹ / ₈ "	54"	11 ¹ / ₂ "	8	8			\$ 3,624	
	TR-CV-5424-A-18-36	Double Face Adder	35 ⁹ / ₁₆ "	25 ¹ / ₈ "	54"	11 ¹ / ₂ "	8	8			\$ 3,342	
 <p>Model Shown TR-CV-6624-S-18-36</p>	TR-CV-6620-S-18-36	Double Face Shelving	36 ¹³ / ₁₆ "	21 ¹ / ₈ "	66"	9 ¹ / ₂ "	8	8			\$ 3,647	
	TR-CV-6620-A-18-36	Double Face Adder	35 ⁹ / ₁₆ "	21 ¹ / ₈ "	66"	9 ¹ / ₂ "	8	8			\$ 3,350	
	TR-CV-6624-S-18-36	Double Face Shelving	36 ¹³ / ₁₆ "	25 ¹ / ₈ "	66"	11 ¹ / ₂ "	8	8			\$ 3,677	
	TR-CV-6624-A-18-36	Double Face Adder	35 ⁹ / ₁₆ "	25 ¹ / ₈ "	66"	11 ¹ / ₂ "	8	8			\$ 3,379	

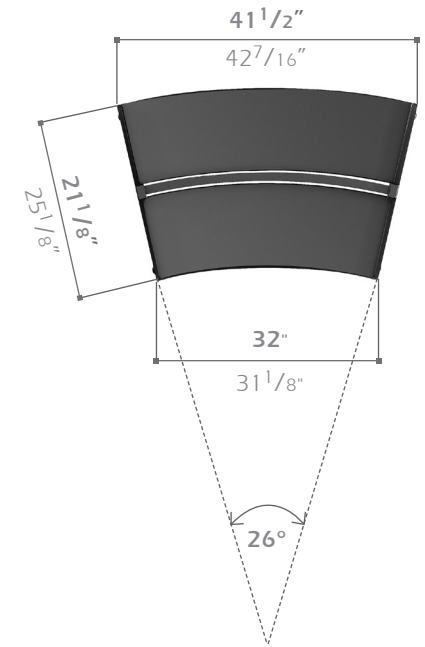

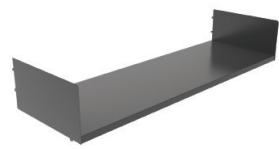
	MODEL NUMBER	PRODUCT	WIDTH	DEPTH	HEIGHT	SHELF DEPTH	# OF SHELVES	# OF OPENINGS	WEIGHT	VOLUME	LIST PRICE	DESCRIPTION
 <p>Model Shown TR-CV-3624-S-26-36</p>	TR-CV-3620-S-26-36	Double Face Shelving	36 ^{13/16} "	21 ^{1/8} "	36"	9 ^{1/2} "	4	4			\$ 2,041	<p>Made of a 1^{1/4}" x 2" metal frame with powder coat paint.</p> <p>METAL FINISHING: All metal components are thoroughly cleaned and coated electrostatically with an epoxy powder coat paint finish. The metal components are then oven baked and cured for a lasting finish.</p> <p>Curved metal shelf with a 1^{1/4}" high book stop back edge.</p>
	TR-CV-3620-A-26-36	Double Face Adder	35 ^{9/16} "	21 ^{1/8} "	36"	9 ^{1/2} "	4	4			\$ 1,868	
	TR-CV-3624-S-26-36	Double Face Shelving	36 ^{13/16} "	25 ^{1/8} "	36"	11 ^{1/2} "	4	4			\$ 2,070	
	TR-CV-3624-A-26-36	Double Face Adder	35 ^{9/16} "	25 ^{1/8} "	36"	11 ^{1/2} "	4	4			\$ 1,899	
 <p>Model Shown TR-CV-4224-S-26-36</p>	TR-CV-4220-S-26-36	Double Face Shelving	36 ^{13/16} "	21 ^{1/8} "	42"	9 ^{1/2} "	6	6			\$ 2,851	
	TR-CV-4220-A-26-36	Double Face Adder	35 ^{9/16} "	21 ^{1/8} "	42"	9 ^{1/2} "	6	6			\$ 2,591	
	TR-CV-4224-S-26-36	Double Face Shelving	36 ^{13/16} "	25 ^{1/8} "	42"	11 ^{1/2} "	6	6			\$ 2,896	
	TR-CV-4224-A-26-36	Double Face Adder	35 ^{9/16} "	25 ^{1/8} "	42"	11 ^{1/2} "	6	6			\$ 2,637	
 <p>Model Shown TR-CV-4824-S-26-36</p>	TR-CV-4820-S-26-36	Double Face Shelving	36 ^{13/16} "	21 ^{1/8} "	48"	9 ^{1/2} "	6	6			\$ 2,895	
	TR-CV-4820-A-26-36	Double Face Adder	35 ^{9/16} "	21 ^{1/8} "	48"	9 ^{1/2} "	6	6			\$ 2,636	
	TR-CV-4824-S-26-36	Double Face Shelving	36 ^{13/16} "	25 ^{1/8} "	48"	11 ^{1/2} "	6	6			\$ 2,947	
	TR-CV-4824-A-26-36	Double Face Adder	35 ^{9/16} "	25 ^{1/8} "	48"	11 ^{1/2} "	6	6			\$ 2,674	
 <p>Model Shown TR-CV-5424-S-26-36</p>	TR-CV-5420-S-26-36	Double Face Shelving	36 ^{13/16} "	21 ^{1/8} "	54"	9 ^{1/2} "	8	8			\$ 3,603	
	TR-CV-5420-A-26-36	Double Face Adder	35 ^{9/16} "	21 ^{1/8} "	54"	9 ^{1/2} "	8	8			\$ 3,304	
	TR-CV-5424-S-26-36	Double Face Shelving	36 ^{13/16} "	25 ^{1/8} "	54"	11 ^{1/2} "	8	8			\$ 3,624	
	TR-CV-5424-A-26-36	Double Face Adder	35 ^{9/16} "	25 ^{1/8} "	54"	11 ^{1/2} "	8	8			\$ 3,342	
 <p>Model Shown TR-CV-6624-S-26-36</p>	TR-CV-6620-S-26-36	Double Face Shelving	36 ^{13/16} "	21 ^{1/8} "	66"	9 ^{1/2} "	8	8			\$ 3,647	
	TR-CV-6620-A-26-36	Double Face Adder	35 ^{9/16} "	21 ^{1/8} "	66"	9 ^{1/2} "	8	8			\$ 3,350	
	TR-CV-6624-S-26-36	Double Face Shelving	36 ^{13/16} "	25 ^{1/8} "	66"	11 ^{1/2} "	8	8			\$ 3,677	
	TR-CV-6624-A-26-36	Double Face Adder	35 ^{9/16} "	25 ^{1/8} "	66"	11 ^{1/2} "	8	8			\$ 3,379	

















	MODEL NUMBER	PRODUCT	WIDTH	DEPTH	HEIGHT	WEIGHT	VOLUME	LIST PRICE	DESCRIPTION
 <p>Model Shown TR-F12-36</p>	TR-F10-24	Flat Metal Shelf	23 1/4"	9 1/2"	6"			\$ 171	Metal shelf with no book stop back edge.
	TR-F12-24		23 1/4"	11 1/2"	6"			\$ 178	
	TR-F14-24		23 1/4"	14"	6"			\$ 178	
	TR-F10-30		29 1/4"	9 1/2"	6"			\$ 171	
	TR-F12-30		29 1/4"	11 1/2"	6"			\$ 178	
	TR-F14-30		29 1/4"	14"	6"			\$ 178	
	TR-F10-36		35 1/4"	9 1/2"	6"			\$ 163	
	TR-F12-36		35 1/4"	11 1/2"	6"			\$ 171	
TR-F14-36	35 1/4"	14"	6"			\$ 178			
 <p>Model Shown TR-LB12-36</p>	TR-LB10-24	Low Back Metal Shelf	23 1/4"	9 1/2"	6"			\$ 178	Metal shelf with a 1 1/4" high book stop back edge.
	TR-LB12-24		23 1/4"	11 1/2"	6"			\$ 187	
	TR-LB14-24		23 1/4"	14"	6"			\$ 194	
	TR-LB10-30		29 1/4"	9 1/2"	6"			\$ 178	
	TR-LB12-30		29 1/4"	11 1/2"	6"			\$ 187	
	TR-LB14-30		29 1/4"	14"	6"			\$ 194	
	TR-LB10-36		35 1/4"	9 1/2"	6"			\$ 178	
	TR-LB12-36		35 1/4"	11 1/2"	6"			\$ 178	
TR-LB14-36	35 1/4"	14"	6"			\$ 187			
 <p>Model Shown TR-SL12-36</p>	TR-SL10-24	Slotted Metal Shelf	23 1/4"	9 1/2"	4 3/4"			\$ 312	Divider shelf is 5" high with 3 metal dividers. Shelf is slotted at 2" intervals.
	TR-SL12-24		23 1/4"	11 1/2"	4 3/4"			\$ 328	
	TR-SL10-30		29 1/4"	9 1/2"	4 3/4"			\$ 312	
	TR-SL12-30		29 1/4"	11 1/2"	4 3/4"			\$ 328	
	TR-SL10-36		35 1/4"	9 1/2"	4 3/4"			\$ 304	
	TR-SL12-36		35 1/4"	11 1/2"	4 3/4"			\$ 312	
 <p>Model Shown TR-M12-36</p>	TR-M12-24	Hinged Magazine Shelf	23 1/4"		12"			\$ 171	Hinged metal magazine shelf with 12" height and 1" deep x 3/4" high lip.
	TR-M12-30		29 1/4"		12"			\$ 171	
	TR-M12-36		35 1/4"		12"			\$ 163	

	MODEL NUMBER	PRODUCT	WIDTH	DEPTH	HEIGHT	WEIGHT	VOLUME	LIST PRICE	DESCRIPTION
 Model Shown TR-C18-12-IN-36	TR-C18-10-IN-36	18° Curved Metal Inside Shelf	34"	9 1/2"	6"			\$ 251	Curved metal shelf with a 1 1/4" high book stop back edge.
	TR-C18-12-IN-36		34"	11 1/2"	6"			\$ 261	
 Model Shown TR-C18-12-OT-36	TR-C18-10-OT-36	18° Curved Metal Outside Shelf	37 1/2"	9 1/2"	6"			\$ 251	
	TR-C18-12-OT-36		38 1/4"	11 1/2"	6"			\$ 261	
 Model Shown TR-C26-12-IN-36	TR-C26-10-IN-36	26° Curved Metal Inside Shelf	33 3/4"	9 1/2"	6"			\$ 251	
	TR-C26-12-IN-36		33 3/4"	11 1/2"	6"			\$ 261	
 Model Shown TR-C26-12-OT-36	TR-C26-10-OT-36	26° Curved Metal Outside Shelf	39"	9 1/2"	6"			\$ 251	
	TR-C26-12-OT-36		39 3/4"	11 1/2"	6"			\$ 261	
 Model Shown TR-BB-10-36	TR-BB-10-24	Browser Box Shelf	23 1/4"	9 1/2"	5 3/4"			\$ 323	Browser box shelf is 5" high with 6 compartments and 5 removable rods to accommodate various media.
	TR-BB-12-24		23 1/4"	11 1/2"	5 3/4"			\$ 339	
	TR-BB-15-24		23 1/4"	15 3/4"	5 3/4"			\$ 363	
 Model Shown TR-BB-12-36	TR-BB-10-30		29 1/4"	9 1/2"	5 3/4"			\$ 335	
	TR-BB-12-30		29 1/4"	11 1/2"	5 3/4"			\$ 351	
	TR-BB-15-30		29 1/4"	15 3/4"	5 3/4"			\$ 375	
 Model Shown TR-BB-15-36	TR-BB-10-36		35 1/4"	9 1/2"	5 3/4"			\$ 347	
	TR-BB-12-36		35 1/4"	11 1/2"	5 3/4"			\$ 363	
	TR-BB-15-36		35 1/4"	15 3/4"	5 3/4"			\$ 388	

	MODEL NUMBER	PRODUCT	WIDTH	DEPTH	HEIGHT	WEIGHT	VOLUME	LIST PRICE	DESCRIPTION
 <p>Model Shown TR-MSL10-36</p>	TR-MSL10-24	Media Shelf: Sloped	23 1/4"	4 3/4"	8"			\$ 171	Metal sloped media shelf with 8" height.
	TR-MSL10-30		29 1/4"	4 3/4"	8"			\$ 183	
	TR-MSL10-36		35 1/4"	4 3/4"	8"			\$ 195	
 <p>Model Shown TR-ZZ12-36</p>	TR-ZZ12-24	Media Shelf: Zig Zag Display	23 1/4"	4 3/4"	6"			\$ 260	Metal multi-media display or storage for compact discs, video tapes or paper back books.
	TR-ZZ12-30		29 1/4"	4 3/4"	6"			\$ 273	
	TR-ZZ12-36		35 1/4"	4 3/4"	6"			\$ 284	
 <p>Model Shown TR-ME12-36</p>	TR-ME12-24	Metal Media Shelf	23 1/4"	4 3/4"	12"	15 Lbs.	1 Cu Ft	\$ 347	18 gauge cold rolled steel with flanges. Front of shelf bent to 90 degrees, 4" high above the shelf. Back flange forms a triple bend End flanges notched to accept 1/16" galvanized shelf support pin. "
	TR-ME12-30		29 1/4"	4 3/4"	12"			\$ 360	
	TR-ME12-36		35 1/4"	4 3/4"	12"			\$ 373	
 <p>Model Shown TR-ND-VT</p>	TR-ND-AC	Media Shelf - New Display			5 3/4"			\$ 39	Metal media shelf displays audio cassettes, compact discs and video tapes. Display is installed front face towards patrons in upright position.
	TR-ND-CD				5 3/4"			\$ 39	
	TR-ND-VT				9"			\$ 54	
 <p>Model Shown TR-H35</p>	TR-H24	Media Shelf - Hanging Bag Rod						\$ 70	Two 3/8" diameter metal rods for media bag storage materials.
	TR-H30							\$ 70	
	TR-H35							\$ 70	
	M-SP-24	24" Metal Media Spacer	23 1/4"	3 1/2"	4 1/2"			\$ 48	Metal media spacers are utilized to reduce shelf space depth in order to accompany various medias such as paperbacks or DVDs. Universally, the spacer can reduce the shelf depth by either 3 1/2" or 4 1/2" in dimension.
	M-SP-30	30" Metal Media Spacer	29 1/4"	3 1/2"	4 1/2"			\$ 48	
	M-SP-36	36" Metal Media Spacer	35 1/4"	3 1/2"	4 1/2"			\$ 44	

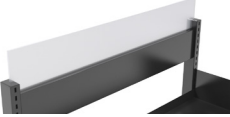

	MODEL NUMBER	PRODUCT	WIDTH	DEPTH	HEIGHT	WEIGHT	VOLUME	LIST PRICE	DESCRIPTION
	TR-M-GSB	Bottom Metal Grooved Shelf Option						\$ 54	Grooved Metal shelf to accept pendant dividers upcharge. Notes: Each Shelf comes with one Pendant Divider. Additional Pendants can be ordered separately.
	PD-01	Wire Pendant Divider						\$ 24	Wire Pendant Divider, chrome finish.
	TR-SL-D10	Divider	9 1/2"		5"			\$ 16	Metal Dividers for divider shelf are 5" high and come in depths of 9 1/2" and 11 1/2".
	TR-SL-D12		11 1/2"		5"			\$ 24	
Model Shown TR-SL-D12									
	WBS-01	Wire Book Support - For Low Back Shelf						\$ 31	Chrome Clip-on wire book support for low back shelves.
	M-BE6	Metal Book End						\$ 24	Metal book end stop with rubber bottoms.
	M-BE9							\$ 31	
Model Shown TR-BE6									
	TR-MS3624	Mobile Shelving Bottom Frame	36"	24"				\$ 568	Not recommended for units higher than 66"
	TR-MSC3624	Mobile Shelving Curved Bottom Frame	36"	24"				\$ 568	Not recommended for units higher than 66"

	MODEL NUMBER	PRODUCT	WIDTH	DEPTH	HEIGHT	WEIGHT	VOLUME	LIST PRICE	DESCRIPTION
 Model Shown TR-JB36	TR-JB24	24" Junction Bar	24"	1 1/8"	5"			\$ 78	Steel junction bars are 1 1/8" x 5" and connect to right and left upright columns. Comes in widths of 24", 30" and 36".
	TR-JB30	30" Junction Bar	30"	1 1/8"	5"			\$ 78	
	TR-JB36	36" Junction Bar	36"	1 1/8"	5"			\$ 78	
 Model Shown TR-KP36	TR-KP24	24" Kickplate	24"		2"			\$ 39	Metal 2" high kickplate installs with two drop-in pins and comes in sizes of 24", 30", and 36" wide.
	TR-KP30	30" Kickplate	30"		2"			\$ 39	
	TR-KP36	36" Kickplate	36"		2"			\$ 31	
 Model Shown TR-CT-BKT-SF	TR-CT-BKT-SF	Single Face Canopy Top Bracket	9 1/2"		5"			\$ 63	One pair of metal brackets for wood canopy tops. Universal size for all depth shelving units. Available in single and double faced applications
	TR-CT-BKT-DF	Double Face Canopy Top Bracket	11 1/2"		5"			\$ 124	
 Model Shown TR-EP-BKT	TR-EP-BKT	Single Face End Panel Bracket Units Below 60" Height						\$ 31	Side and base mounting for finished wood end panels. Available in single and double faced applications.
	TR-EP-BKT-60	Single Face End Panel Bracket Units 60" Height and Above						\$ 54	
 Model Shown TR-EXT-12-SF	TR-EXT12-SF	Single Face Upright Column Extender						\$ 81	Made of 1 1/4" x 2" powder coat painted metal tube. Application extends existing unit height to 12".
	TR-EXT12-DF	Double Face Upright Column Extender						\$ 81	
	TR-SS-SGN	Single Side Signage						Inquire for Quote	
	TR-DS-SGN	Double Side Signage						Inquire for Quote	

	MODEL NUMBER	PRODUCT	WIDTH	DEPTH	HEIGHT	WEIGHT	VOLUME	LIST PRICE	DESCRIPTION
 <p>Model Shown TR-UC-7812</p>	TR-UC-4210	Single Face Upright Column		11 ⁹ / ₁₆ "	42"			\$ 224	Made of a 1 ¹ / ₄ " x 2" metal frame with powder coat paint. Contains adjustable levelers. Metal Shelves adjust by 1" increments.
	TR-UC-4810				48"			\$ 235	
	TR-UC-6610			11 ⁹ / ₁₆ "	66"			\$ 256	
	TR-UC-7810				78"			\$ 281	
	TR-UC-8410			11 ⁹ / ₁₆ "	84"			\$ 312	
	TR-UC-9010				90"			\$ 348	
	TR-UC-4212			13 ⁹ / ₁₆ "	42"			\$ 224	
	TR-UC-4812				48"			\$ 241	
	TR-UC-6612			13 ⁹ / ₁₆ "	66"			\$ 265	
	TR-UC-7812				78"			\$ 288	
	TR-UC-8412		13 ⁹ / ₁₆ "	84"			\$ 319		
	TR-UC-9012			90"			\$ 359		
		TR-UC-4214		16 ¹ / ₁₆ "	42"			\$ 241	METAL FINISHING: All metal components are thoroughly cleaned and coated electrostatically with an epoxy powder coat paint finish. The metal components are then oven baked and cured for a lasting finish.
		TR-UC-4814			48"			\$ 248	
	TR-UC-6614	16 ¹ / ₁₆ "		66"			\$ 273		
	TR-UC-7814			78"			\$ 296		
	TR-UC-8414	16 ¹ / ₁₆ "		84"			\$ 335		
	TR-UC-9014			90"			\$ 373		
 <p>Model Shown TR-UC-7824</p>	TR-UC-4220	Double Face Upright Column		21 ¹ / ₈ "	42"			\$ 265	Made of a 1 ¹ / ₄ " x 2" metal frame with powder coat paint. Contains adjustable levelers. Metal Shelves adjust by 1" increments.
	TR-UC-4820				48"			\$ 273	
	TR-UC-6620			21 ¹ / ₈ "	66"			\$ 296	
	TR-UC-7820				78"			\$ 342	
	TR-UC-8420			21 ¹ / ₈ "	84"			\$ 373	
	TR-UC-9020				90"			\$ 412	
		TR-UC-4224		25 ¹ / ₈ "	42"			\$ 273	METAL FINISHING: All metal components are thoroughly cleaned and coated electrostatically with an epoxy powder coat paint finish. The metal components are then oven baked and cured for a lasting finish.
		TR-UC-4824			48"			\$ 281	
		TR-UC-6624		25 ¹ / ₈ "	66"			\$ 312	
		TR-UC-7824			78"			\$ 348	
		TR-UC-8424		25 ¹ / ₈ "	84"			\$ 381	
		TR-UC-9024			90"			\$ 420	
		TR-UC-4228		30 ¹ / ₈ "	42"			\$ 288	
		TR-UC-4828			48"			\$ 296	
		TR-UC-6628		30 ¹ / ₈ "	66"			\$ 328	
		TR-UC-7828			78"			\$ 373	
		TR-UC-8428		30 ¹ / ₈ "	84"			\$ 397	
		TR-UC-9028			90"			\$ 443	

Palmieri Furniture Limited ("Palmieri") warrants that its products and collections are free from defects in materials and workmanship for the life of the product, except as set forth below. Palmieri Limited Lifetime Warranty is valid from the date of delivery.

Exceptions to the Limited Lifetime Warranty: Seating: two (2) years

Goods sold hereunder are covered by a Limited Lifetime Warranty, free against defects in material and workmanship provided the goods and services are subjected to normal use and service. The applicable warranty period commences from shipping date to Purchaser of any item of the goods, whichever occurs first, or any other warranty period otherwise stipulated in writing by Palmieri under this sale. For components not supplied by Palmieri, the original manufacturer's warranty shall apply to the extent assignable by Palmieri. The obligation under this warranty is limited to the repair or replacement, at Palmieri's option, of defective parts F.O.B. point of shipment provided that prompt notice of any defect is given by Purchaser to Palmieri in writing within the applicable warranty period and that upon the Purchaser's return of the defective parts to Palmieri or, if designated by Palmieri, to the location where the works are made, properly packed and with transportation charges prepaid by Purchaser, an inspection thereof shall reveal to Palmieri's satisfaction that Purchaser's claim is valid under the terms of this warranty. Purchaser shall assume all responsibility and expense for dismantling, removal, re-installation and freight in connection with the foregoing. The same obligations and conditions extend to replacement parts furnished by Palmieri hereunder.

Palmieri does not assume liability for installation, labour or consequential damages. Palmieri makes no warranty other than the one set forth herein. All other warranties, legal, expressed or implied, including but not limited to any expressed or implied warranty of merchantability, of fitness for the intended use thereof or against infringement are hereby expressly excluded. The applicable warranty ceases to be effective if the goods are altered or repaired other than by persons authorized or approved by Palmieri to perform such work. Repairs or replacement deliveries do not interrupt or prolong the term of the warranty. The warranty ceases to be effective if Purchaser fails to handle and use the goods sold hereunder in a safe and reasonable manner and in accordance with any written instructions from the manufacturers.

Warranty Does Not Apply To Product Failure Or Loss Resulting From:

Abuse, misuse or accident, alteration or modification of product by customer or third party, normal wear and tear, improper installation, handling or incorrect use. The substitution of part components or hardware not approved or authorized by Palmieri, acts of God, unauthorized repairs, improper storage, and environmental conditions such as irregular temperature control either inside or outside the environment.

Warranty Provides Exclusive Remedies:

If a product fails under ordinary use as a result of a defect in material or workmanship, Palmieri will: (A) repair, or (B) replace the furniture. The replacement or repair of the Furniture or Seating will be at the discretion of Palmieri. If the defect or workmanship cannot be remedied on site, repairs can be made at the factory. (C) If the product repair or replacement is not commercially practicable or cannot be remade in a timely manner Palmieri will refund the purchase price of the affected product. A product "Defect" means: an inadequacy in the materials or workmanship of the product that (A) existed at the time when you received the product from Palmieri or Palmieri authorized Reseller and (B) causes a failure of the product to perform under ordinary use in accordance with the materials and documentation accompanying the product. "Ordinary Use" means: use of the product (A) in accordance with all applicable local, state or federal laws, codes and regulations and (B) in accordance with manufacturer recommendations and or instructions in the materials and documentation accompanying the product or through shop drawings. A "Palmieri Authorized Reseller" means: any dealer that is legally permitted to conduct business in the jurisdiction where the product is sold and is duly authorized by Palmieri to sell the product.

Warranty work must be approved by authorized personnel of Palmieri Furniture Limited in Richmond Hill, Ontario, Canada.

A copy of the original purchase order must accompany all claims.

Warranty Does Not Cover:

Matching of colours, stains, textures, grains and any other variations in materials. Select and Custom Surfaces and materials are only warranted for their application on the specified product and are not covered by our warranty, except as warranted by the original supplier, for quality, colorfastness, shade variations or abrasion and textiles purchased for Palmieri product.

This limited warranty is the sole remedy for product defect and no other express or implied warranty is provided. Warranty is not transferable and valid only for the original purchaser acquiring a product from Palmieri or a Palmieri authorized reseller for the purchaser's own use and not for resale, remarketing or distribution. Limited Lifetime Warranty (25 years)

GENERAL

The following Terms and Conditions of Quote and Sale shall apply to any sale of goods and services by Palmieri Furniture Limited (hereinafter called "Palmieri"). Purchaser shall be deemed to have full knowledge of the terms and conditions herein and such terms and conditions shall be binding if either the goods and services referred to herein are delivered to and accepted by Purchaser, or if Purchaser does not within five (5) days from the date hereof deliver to Palmieri written objection to said terms and conditions or any part thereof.

In the event of any conflict or inconsistency between the terms and conditions of sale herein and the terms and conditions contained in Purchaser's order or in any other form issued by Purchaser, whether or not any such form has been acknowledged or accepted by Palmieri, Palmieri's terms and conditions herein shall prevail. No waiver, alteration or modification of these terms and conditions shall be binding upon Palmieri unless made in writing and signed by a duly authorized representative of Palmieri.

1. QUOTATIONS / PRODUCT QUOTED

Unless otherwise stated, **Palmieri's quotations shall be null and void unless accepted by Purchaser within thirty (30) days from the date of quotation.** Quotes may be subject to change before order placement, due to increased material costs and or other factors that could impact the final cost of production and our final understanding of the product required. If the items quoted do not reflect the intended product requirements of the customer, Palmieri will not be held responsible for increased costs for those product changes. We reserve the right to edit or re-quote any portion of a previously submitted quotation subject to our final understanding of the product required by the client.

2. PALMIERI DRAWINGS

Palmieri provides drawings for Custom & Standard product we produce to our clients upon request. We consider these drawings to be Private and Confidential and are provided for the sole purpose and use of our clients to understand the product we are providing. The use of these confidential materials is limited to the transaction between the parties and at no point are these confidential materials to be sent to any of our competitors or parties quoting for the same purpose.

A minimum \$ 85.00 NET Engineering Administrative Fee will apply for Custom Product Drawings

(Note: The first set of Custom product drawings will be free of charge)

A minimum \$ 120.00 NET Engineering Administrative Fee will apply for all Standard Product Drawings



3. TERMS OF PAYMENT

For authorized customers; Orders at a \$ 75,000.00 threshold will require a mandatory 25% deposit. Orders over and above \$ 100,000.00 requires a mandatory (25%) deposit at time of order, a mandatory (25%) deposit prior to product shipment and the balance to be paid within thirty (30) days of date of shipment. Payment not be made to Palmieri when due, Palmieri reserves the right to charge Purchaser with interest on such overdue payments. Interest of 2% per month (24% per annum) is charged on all overdue accounts, unless otherwise specified. The charging of such interest shall not be construed as obligating Palmieri to grant any extension of time in the terms of payment. All goods remain the property of Palmieri, until balance is paid in full to Palmieri.

4. TITLE

Title to the goods or any part thereof shall not pass from Palmieri to Purchaser until all payments due hereunder have been duly made, except as otherwise expressly stipulated herein. The goods shall be and remain personal or moveable property, notwithstanding their mode of attachment to realty or other property. If default is made in any of the payments herein, Purchaser agrees that Palmieri may retain all payments which have been made on account of the purchase price as liquidated damages, and Palmieri shall be free to enter the premises where the goods may be located and remove them as Palmieri's property, without prejudice to Palmieri's right to recover any further expenses or damages Palmieri may suffer by reason of such nonpayment.

5. TAXES

Prices do not include Goods & Services Tax, Provincial or Municipal sales, use, value-added or similar tax. All applicable taxes are extra. Our Harmonized Sales Tax (HST) registration number is R104055066.

6. THE AGREEMENT

An acceptance and official confirmation of Purchasers' order by signing Palmieri's Order Confirmation the Purchaser therefore is accepting terms and conditions as expressed herein Palmieri's Terms and Conditions of Quote and Sale by Palmieri and shall constitute the complete agreement, subject to the terms and conditions of sale herein set forth, and shall supersede all previous quotations, orders or agreements.

7. LEAD TIME / DELIVERY / DELAYS

Lead time is determined only when final material/finish selection and drawing approvals are received by Palmieri from the client. The accuracy of Palmieri's lead times, is created to the best of our ability with the information provided to us. Confirmed lead time is conveyed to the client by means of Order Confirmation. They do not preclude the client from checking the accuracy of your requirement and our Order Confirmation. Any noted discrepancies are to be reported immediately to Palmieri Customer Service Department for correction and re-issue of revised Order Confirmation. By signing and dating the Order Confirmation the client accepts the terms and conditions of quote and sale.

Lead time on our Order Confirmation do not account for delays that could potentially occur for special materials specified by the client that are outside of our standard finishes and materials program that are out of our control and will affect the lead time on the order. Palmieri will notify the client immediately when these delays occur and adjust the lead time accordingly.

Delivery schedules are approximate and are based on prevailing market conditions applicable respectively at

the time of Palmieri's quotation and Palmieri's acceptance of clients' order, if certain portions of an order are completed by the quoted lead time while other portions have experienced delays outside of our control. The client may choose to part ship the order at their discretion and expense. Otherwise the entire order will ship with the delayed portion at a later date. Palmieri may extend delivery schedules or may, at its option, cancel Purchaser's order in full or in part without liability other than to return any deposit or prepayment which is unearned by reason of the cancellation.

8. CHANGES AND CANCELLATION

Orders accepted by Palmieri are not subject to changes or cancellation by Purchaser without the written consent of Palmieri. In such cases where Palmieri authorizes changes or cancellation, Palmieri reserves the right to charge the Purchaser with reasonable costs based upon expenses already incurred and commitments made by Palmieri, including, without limitation, any labour done, material purchased and also including Supplier's usual overhead and reasonable profit and cancellation charges from Palmieri's suppliers. Palmieri will communicate to the Purchaser additional costs incurred by way of Revised Order Confirmation. Revised Order Confirmation will include applicable costs incurred and modification to lead times (if applicable). The Purchaser must provide Palmieri written confirmation of additional costs, before any changes can be processed on the order.

A minimum charge of \$ 100.00 NET Change Order Request fee will apply

A minimum charge of \$ 150.00 NET Cancel Order Request fee will apply

9. SHIPPING LOCATION / SHIPPING QUOTES / COST OF TRANSPORTATION

Unless otherwise stated, all prices are F.O.B. our factory in Richmond Hill, Ontario, Canada.

Customary methods of transportation shall be selected by Palmieri and such transportation will be at Purchaser's expense. Shipping quotations are made at time of furniture quotation and are outside the control of Palmieri. **Shipping quotes are valid for ten (10) business days from the time of quote.** We do our best to maintain shipping costs as quoted, however all shipping weights and cubic feet shown are approximate only, various construction materials and packaging methods may add to the weights given. All quoted prices, unless otherwise stated on the quotation, are based on the current exchange rates, tariffs, fuel surcharges and costs of manufacture and are subject to change by Palmieri with or without notice until Purchaser's acceptance. Palmieri does not assume responsibility or liability for shipping costs, product during transit, or variances from the shipping weights or cubic feet shown in our specification guides. Special methods of transportation will be used upon Purchaser's request and at Purchaser's additional expense, provided reasonable notice of Purchaser's transportation requirements are given by Purchaser to Palmieri prior to shipment. Palmieri will notify the client prior to shipping product if shipping costs as quoted change, at which point the client must approve the adjusted shipping costs.

10. RECEIVING PRODUCT / REPORTING DAMAGE / STORAGE OF PRODUCT

Upon receipt of Palmieri product, the receiver of the goods must immediately inspect the product to ensure it is free of shipping damage. If the product is deemed in good order, the receiver of the product must ensure

to sign off on the accompanying carriers Bill of lading in good condition. Except for obligations stated under “Warranty” herein, Palmieri’s responsibility for the product ceases once the product has been received and signed off in good order and is the full responsibility of the receiver and subsequently the owner.

In the event shipping damage is discovered during receipt of shipment, it is the responsibility of the receiver to ensure all noted damage is recorded on the carrier’s Bill of Lading prior to sign off. All noted shipping damage claims must be reported to Palmieri within **24 hours** of receipt of the product onsite, failure to do so will result in the claim being deemed null and void. All shipping damage claims are to be reported directly to Palmieri’s Shipping Manager. Please call our toll free number at **1-800-413-4440 ext. 33** or submit the claim by Fax directly to **1-905-731-9878**. Palmieri will not accept any shipping damage claims submitted **after 24 hours** and it shall be conclusively presumed that the goods were delivered in good condition.

Storage of product, Palmieri will not be held responsible for any potential damages or shortages for product shipped and received by Purchaser and is subsequently placed into storage and not inspected within 24 hours of receipt.

11. INSTALLATION / SHORTAGES / BACK CHARGES

Unless otherwise expressly stipulated, the goods shall be installed by and at the risk and expense of Purchaser.

In the event that Palmieri is requested to supervise such installation, Palmieri’s responsibility shall be limited to exercising that degree of skill customary in the trade in supervising installations of the same type. Purchaser shall remain responsible for all other aspects of the work including compliance with the local regulations. It is the responsibility of the Purchaser to ensure hardware and parts are received in good order. Packing slip and hardware list to be provided by Palmieri with every order at time of shipping. Purchaser has the responsibility to notify Palmieri immediately without delay of issues that arise; subsequently Palmieri will take action to provide prompt resolution.

Shortages must be reported to Palmieri within **24 hours** of receipt of the goods and failure to do so may be at the expense of the Purchaser.

If deemed missing hardware and parts short shipped from the factory, Palmieri will arrange to ship freight prepaid to destination. Palmieri will only be responsible for replacement costs of missing hardware and parts, any labour costs incurred will be the responsibility of the Purchaser and will not be approved by Palmieri.

Back Charges will only be approved if we deemed a defect in the material or workmanship is found during the installation period resulting in a return trip to the job-site to complete installation. It shall remain the sole discretion of Palmieri to approve (A) repair or (B) replace the furniture and any labour costs incurred by the Purchaser.

12. FORCE MAJEURE

Palmieri shall not be responsible or liable for any loss or damage incurred by Purchaser herein resulting from causes beyond the reasonable control of Palmieri including, but without limitation, abuse, misuse or accident, alteration or modification of product by customer or third party, normal wear and tear, improper installation, handling or incorrect use, unauthorized repairs, the substitution of part components or hardware not approved or authorized by Palmieri, improper storage, and environmental conditions such as irregular temperature control

either inside or outside the environment, acts of God, fire, flood, delays in transportation, or the failure of Palmieri’s suppliers to meet their delivery promises. The acceptance of delivery of the goods by Purchaser shall constitute a waiver of all claims for loss or damage due to any delay whatsoever.

13. RETURNED GOODS

No goods may be returned to Palmieri for a credit or exchanged without Palmieri’s prior written consent.

Palmieri reserves the right to accept all returns and subject to a handling/restocking charge or to decline all returns. Even after Palmieri has authorized the return of goods for credit, Palmieri reserves the right to adjust the amount of any credit given to Purchaser on return of the goods based on the conditions of the goods on arrival in Palmieri’s warehouse. Credit for returned goods will be issued to Purchaser only where such goods are returned by Purchaser and not by any subsequent owner of the goods. Goods will be considered for return only if they are in their original condition and packaging. Palmieri Goods Return Authorization Form to be issued and **must** accompany all shipments returning back to the factory. **Return freight must be prepaid by Purchaser. A minimum 20% re-stocking fee will apply.**

PALMIERI

create. communicate. collaborate.

Palmieri Furniture Ltd.

1230 Reid Street
Richmond Hill
Ontario Canada L4B 1C4

T: 905 731 9300
F: 905 731 9878
TF: 800 413 4440

E: info@palmierifurniture.com
W: www.palmierifurniture.com