

PALLMERE

DURECON METAL  
SHELVING  
SPECIFICATION GUIDE  
& PRICE LIST 2024

### WOODS & FINISHES:

#### Natural Maple

Standard



Natural Clear – M-NA

#### Maple Finishes

The following stains are available, add 10% to list



Castle Oak – M-CO



Honey Oak – M-HO



English Oak – M-EN

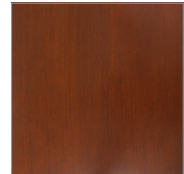

Victorian Cherry – M-VI



Richmond Cherry – M-RC

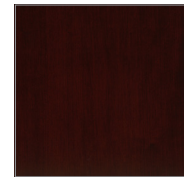

Mahogany – M-MA

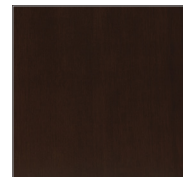

Java – M-JA



Wenge – M-WE

#### Natural Red Oak

Standard

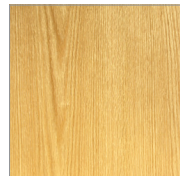

Natural Clear – O-NA

#### Red Oak Finishes

The following stains are available, add 10% to list

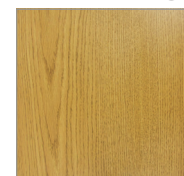

Castle Oak – O-CO



Honey Oak – O-HO

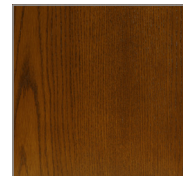

English Oak – O-EN

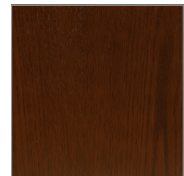

Victorian Cherry – O-VI

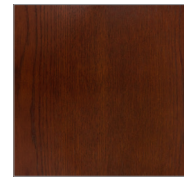

Richmond Cherry – O-RC

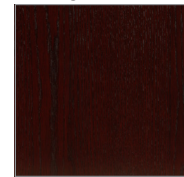

Mahogany – O-MA



Java – O-JA

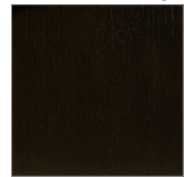

Wenge – O-WE

#### Natural Cherry

Add 20% to list



Natural Clear – C-NA

#### Cherry Finishes

The following stains are available, add 30% to list



Honey Oak – C-HO

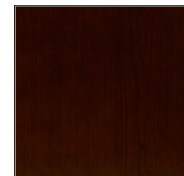

Richmond Cherry – C-RC

#### Natural Walnut

Add 20% to list



Natural Clear – W-NA

#### Walnut Finishes

The following stain is available, add 30% to list

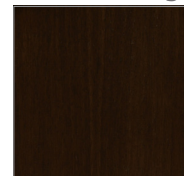

Java – W-JA

### WILSONART® LAMINATES:

Solid, Abstract and Wood Grain Options



Frosty White  
1573-60

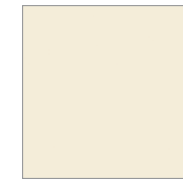

Natural Almond  
D30-60

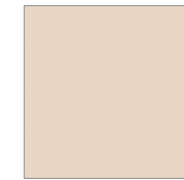

Beige  
1530-60



Fashion Grey  
D381-60



Dove Grey  
D92-60



Slate Grey  
D91-60



Black  
1595-60



Indigo  
D379-60



Maroochy Brush  
4745-60



Woolamai Brush  
4746-60

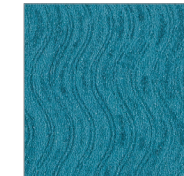

Blue Agave  
4919-60



Eggplant  
4913-60



Spiced Zephyr  
4859-60



Morro Zephyr  
4846-60



Fusion Maple  
7909-60

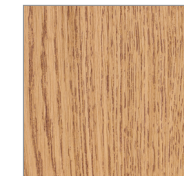

Bannister Oak  
7806-60



Mambo  
7948-60

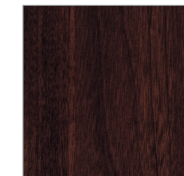

Cocobala  
7942-38



Walnut Heights  
7965-38



Wild Cherry  
7054-60



Phantom Pearl  
8211-38



White Driftwood  
8200-38



Grey Elm  
8201-38



Phantom Cocoa  
8213-38



Studio Teak  
7960-38



Skyline Walnut  
7964-38



Phantom Charcoal  
8214-38



Asian Night  
7949-38







### ABET LAMINATES:

Solid Colour Options

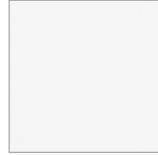
						
Bianco Ghiaccio 410	Beige 416	West Brown 892	Fondente 1828	Grigio Chiaro 478	Grigio Plomo 480	Grigio Scuro 871
						
Grigio Grafite 879	Nero 421	Giallo Pom Pom 463	Giallo Africa 469	Verde Erbetta 460	Sempreverde 451	Verde Biliardo 440
						
Verde Lauro 450	Verde Versailles 845	Bleu Panarea 482	Blu Amorgos 1824	Bleu California 499	Bleu Primario 838	Blu Cobalto 851
						
Blu Pavone 849	Blu Tenebre 1804	Blu Zaffiro 484	Blu Intenso 1818	Viola Madras 423	Viola Tramonto 424	Rosso Prugna 836
						
Rosso Antico 435	Rosso 431	Rosso Cavallino 1822	Arancio Canyon 835	Giallo Pop 861	Viola Sacro 1821	Fucsia 1840
						
Orchidea 1881	Viola Campanula 1827					

### METAL PAINT:

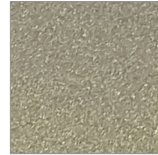
Thermal Paint Colours

						
White PS-111-W374	Antique White W11	Telegrey 4 RAL 7047	Grey A16	Zinc A67	Charcoal A230	Black N49
						
Black Sandtex N31	Sparkle Silver S11	Champagne S14	Beige Gray RAL 7006	Zinc Yellow RAL 1018	Traffic Yellow RAL 1023	Deep Orange RAL 2011
						
Traffic Red RAL 3020	Carmine Red RAL 3002	Purple Red RAL 3004	Claret Violet RAL 4004	Signa Violet RAL 4008	Traffic Purple RAL 4006	Blue Lilac RAL 4005
						
Yellow Green RAL 6018	Signal Green RAL 6032	Turquoise Green RAL 6016	Light Blue RAL 5012	Sky Blue RAL 5015	Gentian Blue RAL 5010	Cobalt Blue RAL 5013

### EDGE BAND COLOURS:

PVC edge band colour options

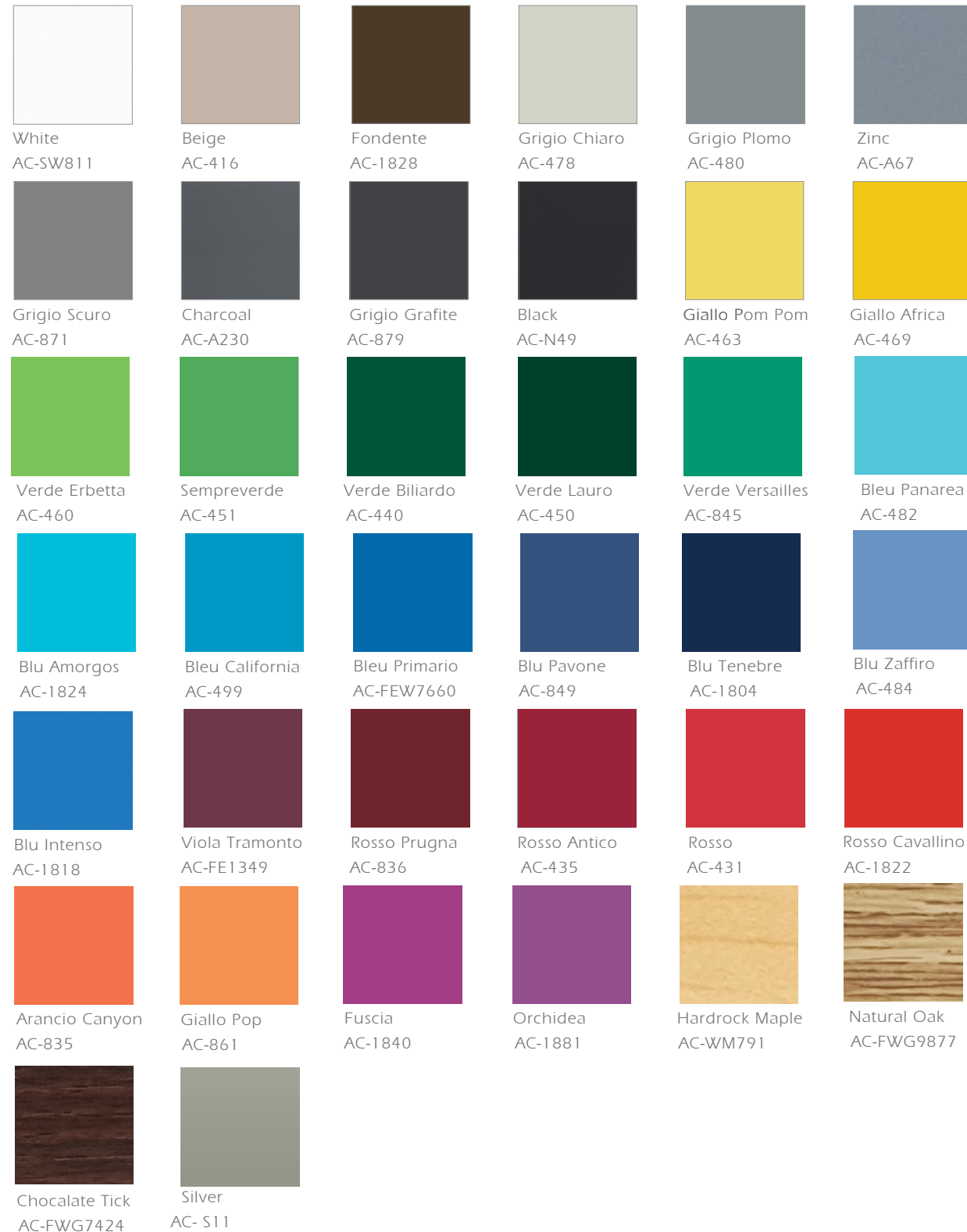

**HARDWOODS:** All hardwood materials used in the manufacturing of Palmieri products shall be Northern grown hardwoods. Hardwoods will be air and kiln dried to a moisture content of 5-7%. All hardwoods shall be of grade "A" material, free of material stains, imperfections, conformity of grain, texture and color. Hardwood species shall be Northern grown Red Oak, Clear White Northern Maple and Birch. American Cherry and Honduras Mahogany and Walnut are available. Please inquire for pricing.

**VENEER:** Exposed face veneers shall be not less than 1/28" thick plain sliced veneers. Veneers are to be selected for conformity of grain direction and color. Veneers are to be stitched tightly in a book match, slip match or plain sliced configuration. Unexposed veneers are to be of hardwood but not selected for color, or grain quality. Veneers are not to be lap joined or reveal any tape or glue lines.

**PARTICLE BOARD CORE:** The particleboard shall be formed of wood chips, bonded with a water resistance adhesive. The particleboard material is to be of a high density 45 lbs/cu. ft. having a minimum average modulus of rupture of 2400 psi and a minimum average modulus of elasticity of 4,000,000 psi.

**VENEER CORE:** Veneer core is to be constructed with odd numbers of plies. Each ply is to be laminated in pairs and cross banded in opposite directions with grain direction at a 90 degree angle to the grain of the center core. All plies are to be free from knots, wrinkles, laps or other natural or manufacturing defects.

**LUMBER CORE:** Lumber core is to be of the highest quality grade. Grade "A" select stock. Lumber core shall be constructed of solid random width strips not less than 2" wide nor more than 3 1/2" wide by 1" thick. Wood strips will be free from knots or other defects. All strips will be tightly joined using water resistance adhesives.



**HIGH PRESSURE LAMINATE:** Work surface laminate shall be .050" thick and used with balancing backer sheet of no less than .028" thick. Laminate shall conform to standards set by the American Standards Institute/National Electrical Manufacturers Association (ANSI/NEMA) for thickness, performance and appearance. Printed colours, abstract patterns and wood grains are reproduced from representative segments of large sheets and may differ slightly from the actual product.



**FINISHING PROCEDURES:** All materials shall be inspected and treated with a final sanding and polishing operation before any staining and final finishing can be performed. All machine and mill marks are to be removed. Once the polishing and sanding has been performed, the furniture will then undergo the following stain and finishing procedures:







- Step 1 A base stain will be uniformly applied, wiped and then allowed to dry under factory controlled conditions.
- Step 2 A uniform coat of sealer will be applied and allowed to dry.
- Step 3 Sealer will be lightly sanded using 240 grit silicon paper.
- Step 4 A catalytic lacquer of 34-45 degree sheen is evenly applied and allowed to dry under factory controlled conditions.







**METAL FINISHING PROCEDURES:** All metal components are thoroughly cleaned and coated electrostatically with an epoxy powder coat paint finish. The metal components are then oven baked and cured for a lasting finish.

**EDGE BANDS:** All edge bands are manufactured in PVC, semi-rigid (Flex) and ABS. Standard edging size are normally 1.25" wide x 2 mm thick. These are made of the highest grade polymers and its materials are extensively tested prior to production using special test procedures and industry specification and quality standards.





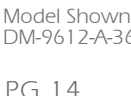

	MODEL NUMBER	PRODUCT	WIDTH	DEPTH	HEIGHT	SHELF DEPTH	# OF SHELVES	# OF OPENINGS	WEIGHT	VOLUME	LIST PRICE	DESCRIPTION
 Model Shown DM-3612-S-36	DM-3010-S-24	Single Face Starter	25 1/4"	10 1/8"	30"	9 1/2"	1	2			\$ 1,360	End, Mid, Top and Base Panels to be constructed from 1" thick 11-ply solid core, veneered 2 sides. Vertical, top and bottom edges banded with 1/4" external hardwood edging, edges to be eased. Front Edge: 3/4" thick x 2 1/2" high fascia - tongue and grooved to top.
	DM-3010-A-24	Single Face Adder	24 1/4"	10 1/8"	30"	9 1/2"	1	2			\$ 934	
	DM-3012-S-24	Single Face Starter	25 1/4"	12 1/8"	30"	11 1/2"	1	2			\$ 1,393	
	DM-3012-A-24	Single Face Adder	24 1/4"	12 1/8"	30"	11 1/2"	1	2			\$ 957	
 Model Shown DM-3612-A-36	DM-3010-S-30	Single Face Starter	31 1/4"	10 1/8"	30"	9 1/2"	1	2			\$ 1,360	
	DM-3010-A-30	Single Face Adder	30 1/4"	10 1/8"	30"	9 1/2"	1	2			\$ 934	
	DM-3012-S-30	Single Face Starter	31 1/4"	12 1/8"	30"	11 1/2"	1	2			\$ 1,393	
	DM-3012-A-30	Single Face Adder	30 1/4"	12 1/8"	30"	11 1/2"	1	2			\$ 957	
	DM-3010-S-36	Single Face Starter	37 1/4"	10 1/8"	30"	9 1/2"	1	2			\$ 1,166	
	DM-3010-A-36	Single Face Adder	36 1/4"	10 1/8"	30"	9 1/2"	1	2			\$ 746	
	DM-3012-S-36	Single Face Starter	37 1/4"	12 1/8"	30"	11 1/2"	1	2			\$ 1,205	
	DM-3012-A-36	Single Face Adder	36 1/4"	12 1/8"	30"	11 1/2"	1	2			\$ 762	
	DM-3610-S-24	Single Face Starter	25 1/4"	10 1/8"	36"	9 1/2"	1	2			\$ 1,360	
	DM-3610-A-24	Single Face Adder	24 1/4"	10 1/8"	36"	9 1/2"	1	2			\$ 971	
	DM-3612-S-24	Single Face Starter	25 1/4"	12 1/8"	36"	11 1/2"	1	2			\$ 1,406	
	DM-3612-A-24	Single Face Adder	24 1/4"	12 1/8"	36"	11 1/2"	1	2			\$ 1,003	
	DM-3610-S-30	Single Face Starter	31 1/4"	10 1/8"	36"	9 1/2"	1	2			\$ 1,360	
	DM-3610-A-30	Single Face Adder	30 1/4"	10 1/8"	36"	9 1/2"	1	2			\$ 971	
	DM-3612-S-30	Single Face Starter	31 1/4"	12 1/8"	36"	11 1/2"	1	2			\$ 1,406	
	DM-3612-A-30	Single Face Adder	30 1/4"	12 1/8"	36"	11 1/2"	1	2			\$ 1,003	
	DM-3610-S-36	Single Face Starter	37 1/4"	10 1/8"	36"	9 1/2"	1	2	50.6 Lbs.	4 Cu Ft	\$ 1,166	
	DM-3610-A-36	Single Face Adder	36 1/4"	10 1/8"	36"	9 1/2"	1	2	46 Lbs.	4 Cu Ft	\$ 777	
	DM-3612-S-36	Single Face Starter	37 1/4"	12 1/8"	36"	11 1/2"	1	2	50.6 Lbs.	5 Cu Ft	\$ 1,220	
	DM-3612-A-36	Single Face Adder	36 1/4"	12 1/8"	36"	11 1/2"	1	2	47.2 Lbs.	5 Cu Ft	\$ 816	



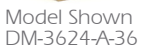

	MODEL NUMBER	PRODUCT	WIDTH	DEPTH	HEIGHT	SHELF DEPTH	# OF SHELVES	# OF OPENINGS	WEIGHT	VOLUME	LIST PRICE	DESCRIPTION
	DM-4210-S-24	Single Face Starter	25 1/4"	10 1/8"	42"	9 1/2"	2	3			\$ 1,447	End, Mid, Top and Base Panels to be constructed from 1" thick 11-ply solid core, veneered 2 sides. Vertical, top and bottom edges banded with 1/4" external hardwood edging, edges to be eased. Front Edge: 3/4" thick x 2 1/2" high fascia - tongue and grooved to top.
	DM-4210-A-24	Single Face Adder	24 1/4"	10 1/8"	42"	9 1/2"	2	3			\$ 1,065	
	DM-4212-S-24	Single Face Starter	25 1/4"	12 1/8"	42"	11 1/2"	2	3			\$ 1,500	
	DM-4212-A-24	Single Face Adder	24 1/4"	12 1/8"	42"	11 1/2"	2	3			\$ 1,095	
	DM-4210-S-30	Single Face Starter	31 1/4"	10 1/8"	42"	9 1/2"	2	3			\$ 1,447	
	DM-4210-A-30	Single Face Adder	30 1/4"	10 1/8"	42"	9 1/2"	2	3			\$ 1,065	
	DM-4212-S-30	Single Face Starter	31 1/4"	12 1/8"	42"	11 1/2"	2	3			\$ 1,500	
	DM-4212-A-30	Single Face Adder	30 1/4"	12 1/8"	42"	11 1/2"	2	3			\$ 1,095	
	DM-4210-S-36	Single Face Starter	37 1/4"	10 1/8"	42"	9 1/2"	2	3	55 Lbs.	5 Cu Ft	\$ 1,259	
	DM-4210-A-36	Single Face Adder	36 1/4"	10 1/8"	42"	9 1/2"	2	3	52 Lbs.	5 Cu Ft	\$ 877	
	DM-4212-S-36	Single Face Starter	37 1/4"	12 1/8"	42"	11 1/2"	2	3	60 Lbs.	5 Cu Ft	\$ 1,313	
	DM-4212-A-36	Single Face Adder	36 1/4"	12 1/8"	42"	11 1/2"	2	3	53 Lbs.	5 Cu Ft	\$ 902	
	DM-4810-S-24	Single Face Starter	25 1/4"	10 1/8"	48"	9 1/2"	2	3			\$ 1,478	
	DM-4810-A-24	Single Face Adder	24 1/4"	10 1/8"	48"	9 1/2"	2	3			\$ 1,081	
	DM-4812-S-24	Single Face Starter	25 1/4"	12 1/8"	48"	11 1/2"	2	3			\$ 1,524	
	DM-4812-A-24	Single Face Adder	24 1/4"	12 1/8"	48"	11 1/2"	2	3			\$ 1,095	
	DM-4810-S-30	Single Face Starter	31 1/4"	10 1/8"	48"	9 1/2"	2	3			\$ 1,478	
	DM-4810-A-30	Single Face Adder	30 1/4"	10 1/8"	48"	9 1/2"	2	3			\$ 1,081	
	DM-4812-S-30	Single Face Starter	31 1/4"	12 1/8"	48"	11 1/2"	2	3			\$ 1,524	
	DM-4812-A-30	Single Face Adder	30 1/4"	12 1/8"	48"	11 1/2"	2	3			\$ 1,095	
	DM-4810-S-36	Single Face Starter	37 1/4"	10 1/8"	48"	9 1/2"	2	3	74.8 Lbs.	5 Cu Ft	\$ 1,290	
	DM-4810-A-36	Single Face Adder	36 1/4"	10 1/8"	48"	9 1/2"	2	3	65.5 Lbs.	5 Cu Ft	\$ 895	
	DM-4812-S-36	Single Face Starter	37 1/4"	12 1/8"	48"	11 1/2"	2	3	82.8 Lbs.	6 Cu Ft	\$ 1,336	
	DM-4812-A-36	Single Face Adder	36 1/4"	12 1/8"	48"	11 1/2"	2	3	71.3 Lbs.	6 Cu Ft	\$ 910	







	MODEL NUMBER	PRODUCT	WIDTH	DEPTH	HEIGHT	SHELF DEPTH	# OF SHELVES	# OF OPENINGS	WEIGHT	VOLUME	LIST PRICE	DESCRIPTION
 <p>Model Shown DM-6012-S-36</p>	DM-6010-S-24	Single Face Starter	25 1/4"	10 1/8"	60"	9 1/2"	3	4			\$ 1,540	End, Mid, Top and Base Panels to be constructed from 1" thick 11-ply solid core, veneered 2 sides. Vertical, top and bottom edges banded with 1/4" external hardwood edging, edges to be eased. Front Edge: 3/4" thick x 2 1/2" high fascia - tongue and grooved to top.
	DM-6010-A-24	Single Face Adder	24 1/4"	10 1/8"	60"	9 1/2"	3	4			\$ 1,151	
	DM-6012-S-24	Single Face Starter	25 1/4"	12 1/8"	60"	11 1/2"	3	4			\$ 1,578	
	DM-6012-A-24	Single Face Adder	24 1/4"	12 1/8"	60"	11 1/2"	3	4			\$ 1,189	
 <p>Model Shown DM-6012-A-36</p>	DM-6010-S-30	Single Face Starter	31 1/4"	10 1/8"	60"	9 1/2"	3	4			\$ 1,540	
	DM-6010-A-30	Single Face Adder	30 1/4"	10 1/8"	60"	9 1/2"	3	4			\$ 1,151	
	DM-6012-S-30	Single Face Starter	31 1/4"	12 1/8"	60"	11 1/2"	3	4			\$ 1,578	
	DM-6012-A-30	Single Face Adder	30 1/4"	12 1/8"	60"	11 1/2"	3	4			\$ 1,189	
 <p>Model Shown DM-6012-A-36</p>	DM-6010-S-36	Single Face Starter	37 1/4"	10 1/8"	60"	9 1/2"	3	4	100 Lbs.	6 Cu Ft	\$ 1,354	
	DM-6010-A-36	Single Face Adder	36 1/4"	10 1/8"	60"	9 1/2"	3	4	86.3 Lbs.	6 Cu Ft	\$ 964	
	DM-6012-S-36	Single Face Starter	37 1/4"	12 1/8"	60"	11 1/2"	3	4	116 Lbs.	8 Cu Ft	\$ 1,393	
	DM-6012-A-36	Single Face Adder	36 1/4"	12 1/8"	60"	11 1/2"	3	4	95.5 Lbs.	7 Cu Ft	\$ 988	
 <p>Model Shown DM-7212-S-36</p>	DM-7210-S-24	Single Face Starter	25 1/4"	10 1/8"	72"	9 1/2"	4	5			\$ 1,633	
	DM-7210-A-24	Single Face Adder	24 1/4"	10 1/8"	72"	9 1/2"	4	5			\$ 1,236	
	DM-7212-S-24	Single Face Starter	25 1/4"	12 1/8"	72"	11 1/2"	4	5			\$ 1,680	
	DM-7212-A-24	Single Face Adder	24 1/4"	12 1/8"	72"	11 1/2"	4	5			\$ 1,275	
 <p>Model Shown DM-7212-A-36</p>	DM-7210-S-30	Single Face Starter	31 1/4"	10 1/8"	72"	9 1/2"	4	5			\$ 1,633	
	DM-7210-A-30	Single Face Adder	30 1/4"	10 1/8"	72"	9 1/2"	4	5			\$ 1,236	
	DM-7212-S-30	Single Face Starter	31 1/4"	12 1/8"	72"	11 1/2"	4	5			\$ 1,680	
	DM-7212-A-30	Single Face Adder	30 1/4"	12 1/8"	72"	11 1/2"	4	5			\$ 1,275	
 <p>Model Shown DM-7212-A-36</p>	DM-7210-S-36	Single Face Starter	37 1/4"	10 1/8"	72"	9 1/2"	4	5	115 Lbs.	7 Cu Ft	\$ 1,439	
	DM-7210-A-36	Single Face Adder	36 1/4"	10 1/8"	72"	9 1/2"	4	5	96.6 Lbs.	7 Cu Ft	\$ 1,049	
	DM-7212-S-36	Single Face Starter	37 1/4"	12 1/8"	72"	11 1/2"	4	5	131 Lbs.	8 Cu Ft	\$ 1,493	
	DM-7212-A-36	Single Face Adder	36 1/4"	12 1/8"	72"	11 1/2"	4	5	109 Lbs.	8 Cu Ft	\$ 1,081	





	MODEL NUMBER	PRODUCT	WIDTH	DEPTH	HEIGHT	SHELF DEPTH	# OF SHELVES	# OF OPENINGS	WEIGHT	VOLUME	LIST PRICE	DESCRIPTION
	DM-8210-S-24	Single Face Starter	25 1/4"	10 1/8"	82"	9 1/2"	5	6			\$ 1,717	End, Mid, Top and Base Panels to be constructed from 1" thick 11-ply solid core, veneered 2 sides. Vertical, top and bottom edges banded with 1/4" external hardwood edging, edges to be eased. Front Edge: 3/4" thick x 2 1/2" high fascia - tongue and grooved to top.
	DM-8210-A-24	Single Face Adder	24 1/4"	10 1/8"	82"	9 1/2"	5	6			\$ 1,329	
	DM-8212-S-24	Single Face Starter	25 1/4"	12 1/8"	82"	11 1/2"	5	6			\$ 1,772	
	DM-8212-A-24	Single Face Adder	24 1/4"	12 1/8"	82"	11 1/2"	5	6			\$ 1,360	
	DM-8210-S-30	Single Face Starter	31 1/4"	10 1/8"	82"	9 1/2"	5	6			\$ 1,717	
	DM-8210-A-30	Single Face Adder	30 1/4"	10 1/8"	82"	9 1/2"	5	6			\$ 1,329	
	DM-8212-S-30	Single Face Starter	31 1/4"	12 1/8"	82"	11 1/2"	5	6			\$ 1,772	
	DM-8212-A-30	Single Face Adder	30 1/4"	12 1/8"	82"	11 1/2"	5	6			\$ 1,360	
	DM-8210-S-36	Single Face Starter	37 1/4"	10 1/8"	82"	9 1/2"	5	6	129 Lbs.	8 Cu Ft	\$ 1,524	
	DM-8210-A-36	Single Face Adder	36 1/4"	10 1/8"	82"	9 1/2"	5	6	107 Lbs.	7 Cu Ft	\$ 1,135	
	DM-8212-S-36	Single Face Starter	37 1/4"	12 1/8"	82"	11 1/2"	5	6	145 Lbs.	9 Cu Ft	\$ 1,578	
	DM-8212-A-36	Single Face Adder	36 1/4"	12 1/8"	82"	11 1/2"	5	6	122 Lbs.	8 Cu Ft	\$ 1,166	
	DM-9610-S-24	Single Face Starter	25 1/4"	10 1/8"	96"	9 1/2"	6	7			\$ 1,795	
	DM-9610-A-24	Single Face Adder	24 1/4"	10 1/8"	96"	9 1/2"	6	7			\$ 1,406	
	DM-9612-S-24	Single Face Starter	25 1/4"	12 1/8"	96"	11 1/2"	6	7			\$ 1,865	
	DM-9612-A-24	Single Face Adder	24 1/4"	12 1/8"	96"	11 1/2"	6	7			\$ 1,454	
	DM-9610-S-30	Single Face Starter	31 1/4"	10 1/8"	96"	9 1/2"	6	7			\$ 1,795	
	DM-9610-A-30	Single Face Adder	30 1/4"	10 1/8"	96"	9 1/2"	6	7			\$ 1,406	
	DM-9612-S-30	Single Face Starter	31 1/4"	12 1/8"	96"	11 1/2"	6	7			\$ 1,865	
	DM-9612-A-30	Single Face Adder	30 1/4"	12 1/8"	96"	11 1/2"	6	7			\$ 1,454	
	DM-9610-S-36	Single Face Starter	37 1/4"	10 1/8"	96"	9 1/2"	6	7	156 Lbs.	9 Cu Ft	\$ 1,610	
	DM-9610-A-36	Single Face Adder	36 1/4"	10 1/8"	96"	9 1/2"	6	7	128 Lbs.	8 Cu Ft	\$ 1,220	
	DM-9612-S-36	Single Face Starter	37 1/4"	12 1/8"	96"	11 1/2"	6	7	177 Lbs.	10 Cu Ft	\$ 1,680	
	DM-9612-A-36	Single Face Adder	36 1/4"	12 1/8"	96"	11 1/2"	6	7	145 Lbs.	9 Cu Ft	\$ 1,268	

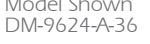

	MODEL NUMBER	PRODUCT	WIDTH	DEPTH	HEIGHT	SHELF DEPTH	# OF SHELVES	# OF OPENINGS	WEIGHT	VOLUME	LIST PRICE	DESCRIPTION
 Model Shown DM-3624-S-36	DM-3620-S-24	Double Face Starter	25 1/4"	19 1/2"	36"	9 1/2"	2	4			\$ 2,387	End, Mid, Top and Base Panels to be constructed from 1" thick 11-ply solid core, veneered 2 sides. Vertical, top and bottom edges banded with 1/4" external hardwood edging, edges to be eased. Front Edge: 3/4" thick x 2 1/2" high fascia - tongue and grooved to top.
	DM-3620-A-24	Double Face Adder	24 1/4"	19 1/2"	36"	9 1/2"	2	4			\$ 1,710	
	DM-3624-S-24	Double Face Starter	25 1/4"	23 1/2"	36"	11 1/2"	2	4			\$ 2,417	
	DM-3624-A-24	Double Face Adder	24 1/4"	23 1/2"	36"	11 1/2"	2	4			\$ 1,727	
 Model Shown DM-3624-A-36	DM-3620-S-30	Double Face Starter	31 1/4"	19 1/2"	36"	9 1/2"	2	4			\$ 2,387	
	DM-3620-A-30	Double Face Adder	30 1/4"	19 1/2"	36"	9 1/2"	2	4			\$ 1,710	
	DM-3624-S-30	Double Face Starter	31 1/4"	23 1/2"	36"	11 1/2"	2	4			\$ 2,417	
	DM-3624-A-30	Double Face Adder	30 1/4"	23 1/2"	36"	11 1/2"	2	4			\$ 1,727	
 Model Shown DM-3624-A-36	DM-3620-S-36	Double Face Starter	37 1/4"	19 1/2"	36"	9 1/2"	2	4	88.6 Lbs.	7 Cu Ft	\$ 2,107	
	DM-3620-A-36	Double Face Adder	36 1/4"	19 1/2"	36"	9 1/2"	2	4	73.6 Lbs.	6 Cu Ft	\$ 1,431	
	DM-3624-S-36	Double Face Starter	37 1/4"	23 1/2"	36"	11 1/2"	2	4	110 Lbs.	10 Cu Ft	\$ 2,139	
	DM-3624-A-36	Double Face Adder	36 1/4"	23 1/2"	36"	11 1/2"	2	4	88.6 Lbs.	9 Cu Ft	\$ 1,439	
 Model Shown DM-4224-S-36	DM-4220-S-24	Double Face Starter	25 1/4"	19 1/2"	42"	9 1/2"	4	6			\$ 2,566	
	DM-4220-A-24	Double Face Adder	24 1/4"	19 1/2"	42"	9 1/2"	4	6			\$ 1,897	
	DM-4224-S-24	Double Face Starter	25 1/4"	23 1/2"	42"	11 1/2"	4	6			\$ 2,605	
	DM-4224-A-24	Double Face Adder	24 1/4"	23 1/2"	42"	11 1/2"	4	6			\$ 1,912	
 Model Shown DM-4224-S-36	DM-4220-S-30	Double Face Starter	31 1/4"	19 1/2"	42"	9 1/2"	4	6			\$ 2,566	
	DM-4220-A-30	Double Face Adder	30 1/4"	19 1/2"	42"	9 1/2"	4	6			\$ 1,897	
	DM-4224-S-30	Double Face Starter	31 1/4"	23 1/2"	42"	11 1/2"	4	6			\$ 2,605	
	DM-4224-A-30	Double Face Adder	30 1/4"	23 1/2"	42"	11 1/2"	4	6			\$ 1,912	
 Model Shown DM-4224-A-36	DM-4220-S-36	Double Face Starter	37 1/4"	19 1/2"	42"	9 1/2"	4	6	94 Lbs.	7 Cu Ft	\$ 2,286	
	DM-4220-A-36	Double Face Adder	36 1/4"	19 1/2"	42"	9 1/2"	4	6	78 Lbs.	7 Cu Ft	\$ 1,610	
	DM-4224-S-36	Double Face Starter	37 1/4"	23 1/2"	42"	11 1/2"	4	6	115 Lbs.	10 Cu Ft	\$ 2,324	
	DM-4224-A-36	Double Face Adder	36 1/4"	23 1/2"	42"	11 1/2"	4	6	113 Lbs.	10 Cu Ft	\$ 1,624	
	DM-4820-S-24	Double Face Starter	25 1/4"	19 1/2"	48"	9 1/2"	4	6			\$ 2,698	
	DM-4820-A-24	Double Face Adder	24 1/4"	19 1/2"	48"	9 1/2"	4	6			\$ 1,983	
	DM-4824-S-24	Double Face Starter	25 1/4"	23 1/2"	48"	11 1/2"	4	6			\$ 2,736	
	DM-4824-A-24	Double Face Adder	24 1/4"	23 1/2"	48"	11 1/2"	4	6			\$ 2,014	
	DM-4820-S-30	Double Face Starter	31 1/4"	19 1/2"	48"	9 1/2"	4	6			\$ 2,698	
	DM-4820-A-30	Double Face Adder	30 1/4"	19 1/2"	48"	9 1/2"	4	6			\$ 1,983	
	DM-4824-S-30	Double Face Starter	31 1/4"	23 1/2"	48"	11 1/2"	4	6			\$ 2,736	
	DM-4824-A-30	Double Face Adder	30 1/4"	23 1/2"	48"	11 1/2"	4	6			\$ 2,014	
	DM-4820-S-36	Double Face Starter	37 1/4"	19 1/2"	48"	9 1/2"	4	6	132 Lbs.	9 Cu Ft	\$ 2,401	
	DM-4820-A-36	Double Face Adder	36 1/4"	19 1/2"	48"	9 1/2"	4	6	109 Lbs.	8 Cu Ft	\$ 1,687	
	DM-4824-S-36	Double Face Starter	37 1/4"	23 1/2"	48"	11 1/2"	4	6	155 Lbs.	11 Cu Ft	\$ 2,441	
	DM-4824-A-36	Double Face Adder	36 1/4"	23 1/2"	48"	11 1/2"	4	6	127 Lbs.	10 Cu Ft	\$ 1,703	

	MODEL NUMBER	PRODUCT	WIDTH	DEPTH	HEIGHT	SHELF DEPTH	# OF SHELVES	# OF OPENINGS	WEIGHT	VOLUME	LIST PRICE	DESCRIPTION
 <p>Model Shown DM-6024-S-36</p>	DM-6020-S-24	Double Face Starter	25 1/4"	19 1/2"	60"	9 1/2"	6	8			\$ 2,722	End, Mid, Top and Base Panels to be constructed from 1" thick 11-ply solid core, veneered 2 sides. Vertical, top and bottom edges banded with 1/4" external hardwood edging, edges to be eased. Front Edge: 3/4" thick x 2 1/2" high fascia - tongue and grooved to top.
	DM-6020-A-24	Double Face Adder	24 1/4"	19 1/2"	60"	9 1/2"	6	8			\$ 2,014	
	DM-6024-S-24	Double Face Starter	25 1/4"	23 1/2"	60"	11 1/2"	6	8			\$ 2,752	
	DM-6024-A-24	Double Face Adder	24 1/4"	23 1/2"	60"	11 1/2"	6	8			\$ 2,060	
	DM-6020-S-30	Double Face Starter	31 1/4"	19 1/2"	60"	9 1/2"	6	8			\$ 2,722	
	DM-6020-A-30	Double Face Adder	30 1/4"	19 1/2"	60"	9 1/2"	6	8			\$ 2,014	
	DM-6024-S-30	Double Face Starter	31 1/4"	23 1/2"	60"	11 1/2"	6	8			\$ 2,752	
	DM-6024-A-30	Double Face Adder	30 1/4"	23 1/2"	60"	11 1/2"	6	8			\$ 2,060	
 <p>Model Shown DM-6024-A-36</p>	DM-6020-S-36	Double Face Starter	37 1/4"	19 1/2"	60"	9 1/2"	6	8	176 Lbs.	11 Cu Ft	\$ 2,433	
	DM-6020-A-36	Double Face Adder	36 1/4"	19 1/2"	60"	9 1/2"	6	8	145 Lbs.	10 Cu Ft	\$ 1,727	
	DM-6024-S-36	Double Face Starter	37 1/4"	23 1/2"	60"	11 1/2"	6	8	200 Lbs.	12 Cu Ft	\$ 2,463	
	DM-6024-A-36	Double Face Adder	36 1/4"	23 1/2"	60"	11 1/2"	6	8	164 Lbs.	11 Cu Ft	\$ 1,765	
 <p>Model Shown DM-7224-S-36</p>	DM-7220-S-24	Double Face Starter	25 1/4"	19 1/2"	72"	9 1/2"	8	10			\$ 2,899	
	DM-7220-A-24	Double Face Adder	24 1/4"	19 1/2"	72"	9 1/2"	8	10			\$ 2,184	
	DM-7224-S-24	Double Face Starter	25 1/4"	23 1/2"	72"	11 1/2"	8	10			\$ 2,930	
	DM-7224-A-24	Double Face Adder	24 1/4"	23 1/2"	72"	11 1/2"	8	10			\$ 2,231	
	DM-7220-S-30	Double Face Starter	31 1/4"	19 1/2"	72"	9 1/2"	8	10			\$ 2,899	
	DM-7220-A-30	Double Face Adder	30 1/4"	19 1/2"	72"	9 1/2"	8	10			\$ 2,184	
	DM-7224-S-30	Double Face Starter	31 1/4"	23 1/2"	72"	11 1/2"	8	10			\$ 2,930	
	DM-7224-A-30	Double Face Adder	30 1/4"	23 1/2"	72"	11 1/2"	8	10			\$ 2,231	
 <p>Model Shown DM-7224-A-36</p>	DM-7220-S-36	Double Face Starter	37 1/4"	19 1/2"	72"	9 1/2"	8	10	200 Lbs.	12 Cu Ft	\$ 2,605	
	DM-7220-A-36	Double Face Adder	36 1/4"	19 1/2"	72"	9 1/2"	8	10	164 Lbs.	11 Cu Ft	\$ 1,897	
	DM-7224-S-36	Double Face Starter	37 1/4"	23 1/2"	72"	11 1/2"	8	10	229 Lbs.	13 Cu Ft	\$ 2,651	
	DM-7224-A-36	Double Face Adder	36 1/4"	23 1/2"	72"	11 1/2"	8	10	186 Lbs.	12 Cu Ft	\$ 1,935	

	MODEL NUMBER	PRODUCT	WIDTH	DEPTH	HEIGHT	SHELF DEPTH	# OF SHELVES	# OF OPENINGS	WEIGHT	VOLUME	LIST PRICE	DESCRIPTION
	DM-8220-S-24	Double Face Starter	25 1/4"	19 1/2"	82"	9 1/2"	10	12			\$ 3,056	End, Mid, Top and Base Panels to be constructed from 1" thick 11-ply solid core, veneered 2 sides. Vertical, top and bottom edges banded with 1/4" external hardwood edging, edges to be eased. Front Edge: 3/4" thick x 2 1/2" high fascia - tongue and grooved to top.
	DM-8220-A-24	Double Face Adder	24 1/4"	19 1/2"	82"	9 1/2"	10	12			\$ 2,356	
	DM-8224-S-24	Double Face Starter	25 1/4"	23 1/2"	82"	11 1/2"	10	12			\$ 3,110	
	DM-8224-A-24	Double Face Adder	24 1/4"	23 1/2"	82"	11 1/2"	10	12			\$ 2,417	
	DM-8220-S-30	Double Face Starter	31 1/4"	19 1/2"	82"	9 1/2"	10	12			\$ 3,056	
	DM-8220-A-30	Double Face Adder	30 1/4"	19 1/2"	82"	9 1/2"	10	12			\$ 2,356	
	DM-8224-S-30	Double Face Starter	31 1/4"	23 1/2"	82"	11 1/2"	10	12			\$ 3,110	
	DM-8224-A-30	Double Face Adder	30 1/4"	23 1/2"	82"	11 1/2"	10	12			\$ 2,417	
	DM-8220-S-36	Double Face Starter	37 1/4"	19 1/2"	82"	9 1/2"	10	12	224 Lbs.	12 Cu Ft	\$ 2,768	
	DM-8220-A-36	Double Face Adder	36 1/4"	19 1/2"	82"	9 1/2"	10	12	184 Lbs.	11 Cu Ft	\$ 2,076	
	DM-8224-S-36	Double Face Starter	37 1/4"	23 1/2"	82"	11 1/2"	10	12	256 Lbs.	14 Cu Ft	\$ 2,822	
	DM-8224-A-36	Double Face Adder	36 1/4"	23 1/2"	82"	11 1/2"	10	12	207 Lbs.	12 Cu Ft	\$ 2,122	
	DM-9620-S-24	Double Face Starter	25 1/4"	19 1/2"	96"	9 1/2"	12	14			\$ 3,234	
	DM-9620-A-24	Double Face Adder	24 1/4"	19 1/2"	96"	9 1/2"	12	14			\$ 2,527	
	DM-9624-S-24	Double Face Starter	25 1/4"	23 1/2"	96"	11 1/2"	12	14			\$ 3,288	
	DM-9624-A-24	Double Face Adder	24 1/4"	23 1/2"	96"	11 1/2"	12	14			\$ 2,588	
	DM-9620-S-30	Double Face Starter	31 1/4"	19 1/2"	96"	9 1/2"	12	14			\$ 3,234	
	DM-9620-A-30	Double Face Adder	30 1/4"	19 1/2"	96"	9 1/2"	12	14			\$ 2,527	
	DM-9624-S-30	Double Face Starter	31 1/4"	23 1/2"	96"	11 1/2"	12	14			\$ 3,288	
	DM-9624-A-30	Double Face Adder	30 1/4"	23 1/2"	96"	11 1/2"	12	14			\$ 2,588	
	DM-9620-S-36	Double Face Starter	37 1/4"	19 1/2"	96"	9 1/2"	12	14	276 Lbs.	13 Cu Ft	\$ 2,946	
	DM-9620-A-36	Double Face Adder	36 1/4"	19 1/2"	96"	9 1/2"	12	14	220 Lbs.	12 Cu Ft	\$ 2,239	
	DM-9624-S-36	Double Face Starter	37 1/4"	23 1/2"	96"	11 1/2"	12	14	315 Lbs.	15 Cu Ft	\$ 2,992	
	DM-9624-A-36	Double Face Adder	36 1/4"	23 1/2"	96"	11 1/2"	12	14	247 Lbs.	13 Cu Ft	\$ 2,301	

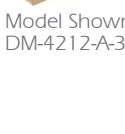
	MODEL NUMBER	PRODUCT	WIDTH	DEPTH	HEIGHT	SHELF DEPTH	# OF SHELVES	# OF OPENINGS	WEIGHT	VOLUME	LIST PRICE	DESCRIPTION
 Model Shown DM-3612-S-36-IPT	DM-3610-S-24-IPT	Single Face Starter	25 1/4"	10 1/8"	36"	9 1/2"	1	2			\$ 1,462	End, Mid, Top and Base Panels to be constructed from 1" thick 11-ply solid core, veneered 2 sides. Vertical, top and bottom edges banded with 1/4" external hardwood edging, edges to be eased. Front Edge: 3/4" thick x 2 1/2" high fascia - tongue and grooved to top.
	DM-3610-A-24-IPT	Single Face Adder	24 1/4"	10 1/8"	36"	9 1/2"	1	2			\$ 1,073	
	DM-3612-S-24-IPT	Single Face Starter	25 1/4"	12 1/8"	36"	11 1/2"	1	2			\$ 1,508	
	DM-3612-A-24-IPT	Single Face Adder	24 1/4"	12 1/8"	36"	11 1/2"	1	2			\$ 1,095	
 Model Shown DM-3612-A-36-IPT	DM-3610-S-30-IPT	Single Face Starter	31 1/4"	10 1/8"	36"	9 1/2"	1	2			\$ 1,462	
	DM-3610-A-30-IPT	Single Face Adder	30 1/4"	10 1/8"	36"	9 1/2"	1	2			\$ 1,073	
	DM-3612-S-30-IPT	Single Face Starter	31 1/4"	12 1/8"	36"	11 1/2"	1	2			\$ 1,508	
	DM-3612-A-30-IPT	Single Face Adder	30 1/4"	12 1/8"	36"	11 1/2"	1	2			\$ 1,095	
 Model Shown DM-3612-A-36-IPT	DM-3610-S-36-IPT	Single Face Starter	37 1/4"	10 1/8"	36"	9 1/2"	1	2	50.6 Lbs.	4 Cu Ft	\$ 1,268	
	DM-3610-A-36-IPT	Single Face Adder	36 1/4"	10 1/8"	36"	9 1/2"	1	2	46 Lbs.	4 Cu Ft	\$ 877	
	DM-3612-S-36-IPT	Single Face Starter	37 1/4"	12 1/8"	36"	11 1/2"	1	2	50.6 Lbs.	5 Cu Ft	\$ 1,313	
	DM-3612-A-36-IPT	Single Face Adder	36 1/4"	12 1/8"	36"	11 1/2"	1	2	47.2 Lbs.	5 Cu Ft	\$ 910	
 Model Shown DM-4212-S-36-IPT	DM-4210-S-24-IPT	Single Face Starter	25 1/4"	10 1/8"	42"	9 1/2"	2	3			\$ 1,540	
	DM-4210-A-24-IPT	Single Face Adder	24 1/4"	10 1/8"	42"	9 1/2"	2	3			\$ 1,158	
	DM-4212-S-24-IPT	Single Face Starter	25 1/4"	12 1/8"	42"	11 1/2"	2	3			\$ 1,593	
	DM-4212-A-24-IPT	Single Face Adder	24 1/4"	12 1/8"	42"	11 1/2"	2	3			\$ 1,189	
 Model Shown DM-4212-A-36-IPT	DM-4210-S-30-IPT	Single Face Starter	31 1/4"	10 1/8"	42"	9 1/2"	2	3			\$ 1,540	
	DM-4210-A-30-IPT	Single Face Adder	30 1/4"	10 1/8"	42"	9 1/2"	2	3			\$ 1,158	
	DM-4212-S-30-IPT	Single Face Starter	31 1/4"	12 1/8"	42"	11 1/2"	2	3			\$ 1,593	
	DM-4212-A-30-IPT	Single Face Adder	30 1/4"	12 1/8"	42"	11 1/2"	2	3			\$ 1,189	
 Model Shown DM-4212-A-36-IPT	DM-4210-S-36-IPT	Single Face Starter	37 1/4"	10 1/8"	42"	9 1/2"	2	3	55 Lbs.	5 Cu Ft	\$ 1,354	
	DM-4210-A-36-IPT	Single Face Adder	36 1/4"	10 1/8"	42"	9 1/2"	2	3	52 Lbs.	5 Cu Ft	\$ 971	
	DM-4212-S-36-IPT	Single Face Starter	37 1/4"	12 1/8"	42"	11 1/2"	2	3	60 Lbs.	5 Cu Ft	\$ 1,406	
	DM-4212-A-36-IPT	Single Face Adder	36 1/4"	12 1/8"	42"	11 1/2"	2	3	53 Lbs.	5 Cu Ft	\$ 1,003	
	DM-4810-S-24-IPT	Single Face Starter	25 1/4"	10 1/8"	48"	9 1/2"	2	3			\$ 1,571	
	DM-4810-A-24-IPT	Single Face Adder	24 1/4"	10 1/8"	48"	9 1/2"	2	3			\$ 1,174	
	DM-4812-S-24-IPT	Single Face Starter	25 1/4"	12 1/8"	48"	11 1/2"	2	3			\$ 1,624	
	DM-4812-A-24-IPT	Single Face Adder	24 1/4"	12 1/8"	48"	11 1/2"	2	3			\$ 1,189	
	DM-4810-S-30-IPT	Single Face Starter	31 1/4"	10 1/8"	48"	9 1/2"	2	3			\$ 1,571	
	DM-4810-A-30-IPT	Single Face Adder	30 1/4"	10 1/8"	48"	9 1/2"	2	3			\$ 1,174	
	DM-4812-S-30-IPT	Single Face Starter	31 1/4"	12 1/8"	48"	11 1/2"	2	3			\$ 1,624	
	DM-4812-A-30-IPT	Single Face Adder	30 1/4"	12 1/8"	48"	11 1/2"	2	3			\$ 1,189	
	DM-4810-S-36-IPT	Single Face Starter	37 1/4"	10 1/8"	48"	9 1/2"	2	3	74.8 Lbs.	5 Cu Ft	\$ 1,393	
	DM-4810-A-36-IPT	Single Face Adder	36 1/4"	10 1/8"	48"	9 1/2"	2	3	65.5 Lbs.	5 Cu Ft	\$ 988	
	DM-4812-S-36-IPT	Single Face Starter	37 1/4"	12 1/8"	48"	11 1/2"	2	3	82.8 Lbs.	6 Cu Ft	\$ 1,439	
	DM-4812-A-36-IPT	Single Face Adder	36 1/4"	12 1/8"	48"	11 1/2"	2	3	71.3 Lbs.	6 Cu Ft	\$ 1,003	





MODEL NUMBER	PRODUCT	WIDTH	DEPTH	HEIGHT	SHELF DEPTH	# OF SHELVES	# OF OPENINGS	WEIGHT	VOLUME	LIST PRICE	DESCRIPTION
DM-6010-S-24-IPT	Single Face Starter	25 1/4"	10 1/8"	60"	9 1/2"	3	4			\$ 1,641	End, Mid, Top and Base Panels to be constructed from 1" thick 11-ply solid core, veneered 2 sides. Vertical, top and bottom edges banded with 1/4" external hardwood edging, edges to be eased. Front Edge: 3/4" thick x 2 1/2" high fascia - tongue and grooved to top.
DM-6010-A-24-IPT	Single Face Adder	24 1/4"	10 1/8"	60"	9 1/2"	3	4			\$ 1,251	
DM-6012-S-24-IPT	Single Face Starter	25 1/4"	12 1/8"	60"	11 1/2"	3	4			\$ 1,680	
DM-6012-A-24-IPT	Single Face Adder	24 1/4"	12 1/8"	60"	11 1/2"	3	4			\$ 1,282	
DM-6010-S-30-IPT	Single Face Starter	31 1/4"	10 1/8"	60"	9 1/2"	3	4			\$ 1,641	
DM-6010-A-30-IPT	Single Face Adder	30 1/4"	10 1/8"	60"	9 1/2"	3	4			\$ 1,251	
DM-6012-S-30-IPT	Single Face Starter	31 1/4"	12 1/8"	60"	11 1/2"	3	4			\$ 1,680	
DM-6012-A-30-IPT	Single Face Adder	30 1/4"	12 1/8"	60"	11 1/2"	3	4			\$ 1,282	
DM-6010-S-36-IPT	Single Face Starter	37 1/4"	10 1/8"	60"	9 1/2"	3	4	100 Lbs.	6 Cu Ft	\$ 1,454	
DM-6010-A-36-IPT	Single Face Adder	36 1/4"	10 1/8"	60"	9 1/2"	3	4	86.3 Lbs.	6 Cu Ft	\$ 1,065	
DM-6012-S-36-IPT	Single Face Starter	37 1/4"	12 1/8"	60"	11 1/2"	3	4	116 Lbs.	8 Cu Ft	\$ 1,493	
DM-6012-A-36-IPT	Single Face Adder	36 1/4"	12 1/8"	60"	11 1/2"	3	4	95.5 Lbs.	7 Cu Ft	\$ 1,088	



Model Shown  
DM-6012-S-36-IPT

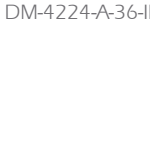

Model Shown  
DM-6012-A-36-IPT

	MODEL NUMBER	PRODUCT	WIDTH	DEPTH	HEIGHT	SHELF DEPTH	# OF SHELVES	# OF OPENINGS	WEIGHT	VOLUME	LIST PRICE	DESCRIPTION
 Model Shown DM-3624-S-36-IPT	DM-3620-S-24-IPT	Double Face Starter	25 1/4"	19 1/2"	36"	9 1/2"	2	4			\$ 2,581	End, Mid, Top and Base Panels to be constructed from 1" thick 11-ply solid core, veneered 2 sides. Vertical, top and bottom edges banded with 1/4" external hardwood edging, edges to be eased. Front Edge: 3/4" thick x 2 1/2" high fascia - tongue and grooved to top.
	DM-3620-A-24-IPT	Double Face Adder	24 1/4"	19 1/2"	36"	9 1/2"	2	4			\$ 1,904	
	DM-3624-S-24-IPT	Double Face Starter	25 1/4"	23 1/2"	36"	11 1/2"	2	4			\$ 2,619	
	DM-3624-A-24-IPT	Double Face Adder	24 1/4"	23 1/2"	36"	11 1/2"	2	4			\$ 1,920	
 Model Shown DM-3624-S-30-IPT	DM-3620-S-30-IPT	Double Face Starter	31 1/4"	19 1/2"	36"	9 1/2"	2	4			\$ 2,581	
	DM-3620-A-30-IPT	Double Face Adder	30 1/4"	19 1/2"	36"	9 1/2"	2	4			\$ 1,904	
	DM-3624-S-30-IPT	Double Face Starter	31 1/4"	23 1/2"	36"	11 1/2"	2	4			\$ 2,619	
	DM-3624-A-30-IPT	Double Face Adder	30 1/4"	23 1/2"	36"	11 1/2"	2	4			\$ 1,920	
 Model Shown DM-3624-A-36-IPT	DM-3620-S-36-IPT	Double Face Starter	37 1/4"	19 1/2"	36"	9 1/2"	2	4	88.6 Lbs.	7 Cu Ft	\$ 2,301	
	DM-3620-A-36-IPT	Double Face Adder	36 1/4"	19 1/2"	36"	9 1/2"	2	4	73.6 Lbs.	6 Cu Ft	\$ 1,624	
	DM-3624-S-36-IPT	Double Face Starter	37 1/4"	23 1/2"	36"	11 1/2"	2	4	110 Lbs.	10 Cu Ft	\$ 2,332	
	DM-3624-A-36-IPT	Double Face Adder	36 1/4"	23 1/2"	36"	11 1/2"	2	4	88.6 Lbs.	9 Cu Ft	\$ 1,633	
 Model Shown DM-4224-S-36-IPT	DM-4220-S-24-IPT	Double Face Starter	25 1/4"	19 1/2"	42"	9 1/2"	4	6			\$ 2,760	
	DM-4220-A-24-IPT	Double Face Adder	24 1/4"	19 1/2"	42"	9 1/2"	4	6			\$ 2,091	
	DM-4224-S-24-IPT	Double Face Starter	25 1/4"	23 1/2"	42"	11 1/2"	4	6			\$ 2,806	
	DM-4224-A-24-IPT	Double Face Adder	24 1/4"	23 1/2"	42"	11 1/2"	4	6			\$ 2,107	
 Model Shown DM-4224-S-30-IPT	DM-4220-S-30-IPT	Double Face Starter	31 1/4"	19 1/2"	42"	9 1/2"	4	6			\$ 2,760	
	DM-4220-A-30-IPT	Double Face Adder	30 1/4"	19 1/2"	42"	9 1/2"	4	6			\$ 2,091	
	DM-4224-S-30-IPT	Double Face Starter	31 1/4"	23 1/2"	42"	11 1/2"	4	6			\$ 2,806	
	DM-4224-A-30-IPT	Double Face Adder	30 1/4"	23 1/2"	42"	11 1/2"	4	6			\$ 2,107	
 Model Shown DM-4224-A-36-IPT	DM-4220-S-36-IPT	Double Face Starter	37 1/4"	19 1/2"	42"	9 1/2"	4	6	94 Lbs.	7 Cu Ft	\$ 2,481	
	DM-4220-A-36-IPT	Double Face Adder	36 1/4"	19 1/2"	42"	9 1/2"	4	6	78 Lbs.	7 Cu Ft	\$ 1,795	
	DM-4224-S-36-IPT	Double Face Starter	37 1/4"	23 1/2"	42"	11 1/2"	4	6	115 Lbs.	10 Cu Ft	\$ 2,519	
	DM-4224-A-36-IPT	Double Face Adder	36 1/4"	23 1/2"	42"	11 1/2"	4	6	113 Lbs.	10 Cu Ft	\$ 1,811	
	DM-4820-S-24-IPT	Double Face Starter	25 1/4"	19 1/2"	48"	9 1/2"	4	6			\$ 2,892	
	DM-4820-A-24-IPT	Double Face Adder	24 1/4"	19 1/2"	48"	9 1/2"	4	6			\$ 2,177	
	DM-4824-S-24-IPT	Double Face Starter	25 1/4"	23 1/2"	48"	11 1/2"	4	6			\$ 2,930	
	DM-4824-A-24-IPT	Double Face Adder	24 1/4"	23 1/2"	48"	11 1/2"	4	6			\$ 2,200	
	DM-4820-S-30-IPT	Double Face Starter	31 1/4"	19 1/2"	48"	9 1/2"	4	6			\$ 2,892	
	DM-4820-A-30-IPT	Double Face Adder	30 1/4"	19 1/2"	48"	9 1/2"	4	6			\$ 2,177	
	DM-4824-S-30-IPT	Double Face Starter	31 1/4"	23 1/2"	48"	11 1/2"	4	6			\$ 2,930	
	DM-4824-A-30-IPT	Double Face Adder	30 1/4"	23 1/2"	48"	11 1/2"	4	6			\$ 2,200	
	DM-4820-S-36-IPT	Double Face Starter	37 1/4"	19 1/2"	48"	9 1/2"	4	6	132 Lbs.	9 Cu Ft	\$ 2,588	
	DM-4820-A-36-IPT	Double Face Adder	36 1/4"	19 1/2"	48"	9 1/2"	4	6	109 Lbs.	8 Cu Ft	\$ 1,881	
	DM-4824-S-36-IPT	Double Face Starter	37 1/4"	23 1/2"	48"	11 1/2"	4	6	155 Lbs.	11 Cu Ft	\$ 2,636	
	DM-4824-A-36-IPT	Double Face Adder	36 1/4"	23 1/2"	48"	11 1/2"	4	6	127 Lbs.	10 Cu Ft	\$ 1,897	







Model Shown  
DM-6024-S-36-IPT













Model Shown  
DM-6024-A-36-IPT





MODEL NUMBER	PRODUCT	WIDTH	DEPTH	HEIGHT	SHELF DEPTH	# OF SHELVES	# OF OPENINGS	WEIGHT	VOLUME	LIST PRICE	DESCRIPTION
DM-6020-S-24-IPT	Double Face Starter	25 1/4"	19 1/2"	60"	9 1/2"	6	8			\$ 2,915	End, Mid, Top and Base Panels to be constructed from 1" thick 11-ply solid core, veneered 2 sides. Vertical, top and bottom edges banded with 1/4" external hardwood edging, edges to be eased. Front Edge: 3/4" thick x 2 1/2" high fascia - tongue and grooved to top.
DM-6020-A-24-IPT	Double Face Adder	24 1/4"	19 1/2"	60"	9 1/2"	6	8			\$ 2,215	
DM-6024-S-24-IPT	Double Face Starter	25 1/4"	23 1/2"	60"	11 1/2"	6	8			\$ 2,946	
DM-6024-A-24-IPT	Double Face Adder	24 1/4"	23 1/2"	60"	11 1/2"	6	8			\$ 2,254	
DM-6020-S-30-IPT	Double Face Starter	31 1/4"	19 1/2"	60"	9 1/2"	6	8			\$ 2,915	
DM-6020-A-30-IPT	Double Face Adder	30 1/4"	19 1/2"	60"	9 1/2"	6	8			\$ 2,215	
DM-6024-S-30-IPT	Double Face Starter	31 1/4"	23 1/2"	60"	11 1/2"	6	8			\$ 2,946	
DM-6024-A-30-IPT	Double Face Adder	30 1/4"	23 1/2"	60"	11 1/2"	6	8			\$ 2,254	
DM-6020-S-36-IPT	Double Face Starter	37 1/4"	19 1/2"	60"	9 1/2"	6	8	176 Lbs.	11 Cu Ft	\$ 2,619	
DM-6020-A-36-IPT	Double Face Adder	36 1/4"	19 1/2"	60"	9 1/2"	6	8	145 Lbs.	10 Cu Ft	\$ 1,920	
DM-6024-S-36-IPT	Double Face Starter	37 1/4"	23 1/2"	60"	11 1/2"	6	8	200 Lbs.	12 Cu Ft	\$ 2,659	
DM-6024-A-36-IPT	Double Face Adder	36 1/4"	23 1/2"	60"	11 1/2"	6	8	164 Lbs.	11 Cu Ft	\$ 1,958	





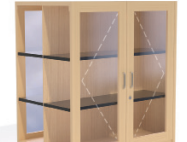
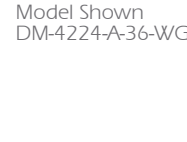

	MODEL NUMBER	PRODUCT	WIDTH	DEPTH	HEIGHT	SHELF DEPTH	# OF SHELVES	# OF OPENINGS	WEIGHT	VOLUME	LIST PRICE	DESCRIPTION
 <p>Model Shown DM-3612-S-36-WG</p>  <p>Model Shown DM-3612-A-36-WG</p>	DM-3610-S-24-WG	Single Face Starter	25 <sup>1</sup> / <sub>4</sub> "	10 <sup>1</sup> / <sub>8</sub> "	36"	8 <sup>1</sup> / <sub>2</sub> "	1	2			\$ 2,487	End, Mid, Top and Base Panels to be constructed from 1" thick 11-ply solid core, veneered 2 sides. Vertical, top and bottom edges banded with 1/4" external hardwood edging, edges to be eased. Front Edge: 3/4" thick x 2 1/2" high fascia - tongue and grooved to top.
	DM-3610-A-24-WG	Single Face Adder	24 <sup>1</sup> / <sub>4</sub> "	10 <sup>1</sup> / <sub>8</sub> "	36"	8 <sup>1</sup> / <sub>2</sub> "	1	2			\$ 2,122	
	DM-3612-S-24-WG	Single Face Starter	25 <sup>1</sup> / <sub>4</sub> "	12 <sup>1</sup> / <sub>8</sub> "	36"	10 <sup>1</sup> / <sub>2</sub> "	1	2			\$ 2,535	
	DM-3612-A-24-WG	Single Face Adder	24 <sup>1</sup> / <sub>4</sub> "	12 <sup>1</sup> / <sub>8</sub> "	36"	10 <sup>1</sup> / <sub>2</sub> "	1	2			\$ 2,153	
	DM-3610-S-30-WG	Single Face Starter	31 <sup>1</sup> / <sub>4</sub> "	10 <sup>1</sup> / <sub>8</sub> "	36"	8 <sup>1</sup> / <sub>2</sub> "	1	2			\$ 2,487	
	DM-3610-A-30-WG	Single Face Adder	30 <sup>1</sup> / <sub>4</sub> "	10 <sup>1</sup> / <sub>8</sub> "	36"	8 <sup>1</sup> / <sub>2</sub> "	1	2			\$ 2,122	
	DM-3612-S-30-WG	Single Face Starter	31 <sup>1</sup> / <sub>4</sub> "	12 <sup>1</sup> / <sub>8</sub> "	36"	10 <sup>1</sup> / <sub>2</sub> "	1	2			\$ 2,535	
	DM-3612-A-30-WG	Single Face Adder	30 <sup>1</sup> / <sub>4</sub> "	12 <sup>1</sup> / <sub>8</sub> "	36"	10 <sup>1</sup> / <sub>2</sub> "	1	2			\$ 2,153	
	DM-3610-S-36-WG	Single Face Starter	37 <sup>1</sup> / <sub>4</sub> "	10 <sup>1</sup> / <sub>8</sub> "	36"	8 <sup>1</sup> / <sub>2</sub> "	1	2	50.6 Lbs.	4 Cu Ft	\$ 2,309	
	DM-3610-A-36-WG	Single Face Adder	36 <sup>1</sup> / <sub>4</sub> "	10 <sup>1</sup> / <sub>8</sub> "	36"	8 <sup>1</sup> / <sub>2</sub> "	1	2	46 Lbs.	4 Cu Ft	\$ 1,935	
	DM-3612-S-36-WG	Single Face Starter	37 <sup>1</sup> / <sub>4</sub> "	12 <sup>1</sup> / <sub>8</sub> "	36"	10 <sup>1</sup> / <sub>2</sub> "	1	2	50.6 Lbs.	5 Cu Ft	\$ 2,356	
	DM-3612-A-36-WG	Single Face Adder	36 <sup>1</sup> / <sub>4</sub> "	12 <sup>1</sup> / <sub>8</sub> "	36"	10 <sup>1</sup> / <sub>2</sub> "	1	2	47.2 Lbs.	5 Cu Ft	\$ 1,965	
 <p>Model Shown DM-4212-S-36-WG</p>  <p>Model Shown DM-4212-A-36-WG</p>	DM-4210-S-24-WG	Single Face Starter	25 <sup>1</sup> / <sub>4</sub> "	10 <sup>1</sup> / <sub>8</sub> "	42"	8 <sup>1</sup> / <sub>2</sub> "	2	3			\$ 2,588	
	DM-4210-A-24-WG	Single Face Adder	24 <sup>1</sup> / <sub>4</sub> "	10 <sup>1</sup> / <sub>8</sub> "	42"	8 <sup>1</sup> / <sub>2</sub> "	2	3			\$ 2,231	
	DM-4212-S-24-WG	Single Face Starter	25 <sup>1</sup> / <sub>4</sub> "	12 <sup>1</sup> / <sub>8</sub> "	42"	10 <sup>1</sup> / <sub>2</sub> "	2	3			\$ 2,651	
	DM-4212-A-24-WG	Single Face Adder	24 <sup>1</sup> / <sub>4</sub> "	12 <sup>1</sup> / <sub>8</sub> "	42"	10 <sup>1</sup> / <sub>2</sub> "	2	3			\$ 2,263	
	DM-4210-S-30-WG	Single Face Starter	31 <sup>1</sup> / <sub>4</sub> "	10 <sup>1</sup> / <sub>8</sub> "	42"	8 <sup>1</sup> / <sub>2</sub> "	2	3			\$ 2,588	
	DM-4210-A-30-WG	Single Face Adder	30 <sup>1</sup> / <sub>4</sub> "	10 <sup>1</sup> / <sub>8</sub> "	42"	8 <sup>1</sup> / <sub>2</sub> "	2	3			\$ 2,231	
	DM-4212-S-30-WG	Single Face Starter	31 <sup>1</sup> / <sub>4</sub> "	12 <sup>1</sup> / <sub>8</sub> "	42"	10 <sup>1</sup> / <sub>2</sub> "	2	3			\$ 2,651	
	DM-4212-A-30-WG	Single Face Adder	30 <sup>1</sup> / <sub>4</sub> "	12 <sup>1</sup> / <sub>8</sub> "	42"	10 <sup>1</sup> / <sub>2</sub> "	2	3			\$ 2,263	
	DM-4210-S-36-WG	Single Face Starter	37 <sup>1</sup> / <sub>4</sub> "	10 <sup>1</sup> / <sub>8</sub> "	42"	8 <sup>1</sup> / <sub>2</sub> "	2	3	55 Lbs.	5 Cu Ft	\$ 2,417	
	DM-4210-A-36-WG	Single Face Adder	36 <sup>1</sup> / <sub>4</sub> "	10 <sup>1</sup> / <sub>8</sub> "	42"	8 <sup>1</sup> / <sub>2</sub> "	2	3	52 Lbs.	5 Cu Ft	\$ 2,053	
	DM-4212-S-36-WG	Single Face Starter	37 <sup>1</sup> / <sub>4</sub> "	12 <sup>1</sup> / <sub>8</sub> "	42"	10 <sup>1</sup> / <sub>2</sub> "	2	3	60 Lbs.	5 Cu Ft	\$ 2,473	
	DM-4212-A-36-WG	Single Face Adder	36 <sup>1</sup> / <sub>4</sub> "	12 <sup>1</sup> / <sub>8</sub> "	42"	10 <sup>1</sup> / <sub>2</sub> "	2	3	53 Lbs.	5 Cu Ft	\$ 2,083	
 <p>Model Shown DM-4812-S-36-WG</p>	DM-4810-S-24-WG	Single Face Starter	25 <sup>1</sup> / <sub>4</sub> "	10 <sup>1</sup> / <sub>8</sub> "	48"	8 <sup>1</sup> / <sub>2</sub> "	2	3			\$ 2,666	
	DM-4810-A-24-WG	Single Face Adder	24 <sup>1</sup> / <sub>4</sub> "	10 <sup>1</sup> / <sub>8</sub> "	48"	8 <sup>1</sup> / <sub>2</sub> "	2	3			\$ 2,286	
	DM-4812-S-24-WG	Single Face Starter	25 <sup>1</sup> / <sub>4</sub> "	12 <sup>1</sup> / <sub>8</sub> "	48"	10 <sup>1</sup> / <sub>2</sub> "	2	3			\$ 2,690	
	DM-4812-A-24-WG	Single Face Adder	24 <sup>1</sup> / <sub>4</sub> "	12 <sup>1</sup> / <sub>8</sub> "	48"	10 <sup>1</sup> / <sub>2</sub> "	2	3			\$ 2,317	
	DM-4810-S-30-WG	Single Face Starter	31 <sup>1</sup> / <sub>4</sub> "	10 <sup>1</sup> / <sub>8</sub> "	48"	8 <sup>1</sup> / <sub>2</sub> "	2	3			\$ 2,666	
	DM-4810-A-30-WG	Single Face Adder	30 <sup>1</sup> / <sub>4</sub> "	10 <sup>1</sup> / <sub>8</sub> "	48"	8 <sup>1</sup> / <sub>2</sub> "	2	3			\$ 2,286	
	DM-4812-S-30-WG	Single Face Starter	31 <sup>1</sup> / <sub>4</sub> "	12 <sup>1</sup> / <sub>8</sub> "	48"	10 <sup>1</sup> / <sub>2</sub> "	2	3			\$ 2,690	
	DM-4812-A-30-WG	Single Face Adder	30 <sup>1</sup> / <sub>4</sub> "	12 <sup>1</sup> / <sub>8</sub> "	48"	10 <sup>1</sup> / <sub>2</sub> "	2	3			\$ 2,317	
	DM-4810-S-36-WG	Single Face Starter	37 <sup>1</sup> / <sub>4</sub> "	10 <sup>1</sup> / <sub>8</sub> "	48"	8 <sup>1</sup> / <sub>2</sub> "	2	3	74.8 Lbs.	5 Cu Ft	\$ 2,487	
	DM-4810-A-36-WG	Single Face Adder	36 <sup>1</sup> / <sub>4</sub> "	10 <sup>1</sup> / <sub>8</sub> "	48"	8 <sup>1</sup> / <sub>2</sub> "	2	3	65.5 Lbs.	5 Cu Ft	\$ 2,107	
	DM-4812-S-36-WG	Single Face Starter	37 <sup>1</sup> / <sub>4</sub> "	12 <sup>1</sup> / <sub>8</sub> "	48"	10 <sup>1</sup> / <sub>2</sub> "	2	3	82.8 Lbs.	6 Cu Ft	\$ 2,512	
	DM-4812-A-36-WG	Single Face Adder	36 <sup>1</sup> / <sub>4</sub> "	12 <sup>1</sup> / <sub>8</sub> "	48"	10 <sup>1</sup> / <sub>2</sub> "	2	3	71.3 Lbs.	6 Cu Ft	\$ 2,107	













	MODEL NUMBER	PRODUCT	WIDTH	DEPTH	HEIGHT	SHELF DEPTH	# OF SHELVES	# OF OPENINGS	WEIGHT	VOLUME	LIST PRICE	DESCRIPTION
	DM-6010-S-24-WG	Single Face Starter	25 1/4"	10 1/8"	60"	8 1/2"	3	4			\$ 3,397	End, Mid, Top and Base Panels to be constructed from 1" thick 11-ply solid core, veneered 2 sides. Vertical, top and bottom edges banded with 1/4" external hardwood edging, edges to be eased. Front Edge: 3/4" thick x 2 1/2" high fascia - tongue and grooved to top.
	DM-6010-A-24-WG	Single Face Adder	24 1/4"	10 1/8"	60"	8 1/2"	3	4			\$ 3,023	
	DM-6012-S-24-WG	Single Face Starter	25 1/4"	12 1/8"	60"	10 1/2"	3	4			\$ 3,451	
	DM-6012-A-24-WG	Single Face Adder	24 1/4"	12 1/8"	60"	10 1/2"	3	4			\$ 3,064	
	DM-6010-S-30-WG	Single Face Starter	31 1/4"	10 1/8"	60"	8 1/2"	3	4			\$ 3,397	
	DM-6010-A-30-WG	Single Face Adder	30 1/4"	10 1/8"	60"	8 1/2"	3	4			\$ 3,023	
	DM-6012-S-30-WG	Single Face Starter	31 1/4"	12 1/8"	60"	10 1/2"	3	4			\$ 3,451	
	DM-6012-A-30-WG	Single Face Adder	30 1/4"	12 1/8"	60"	10 1/2"	3	4			\$ 3,064	
	DM-6010-S-36-WG	Single Face Starter	37 1/4"	10 1/8"	60"	8 1/2"	3	4	100 Lbs.	6 Cu Ft	\$ 3,210	
	DM-6010-A-36-WG	Single Face Adder	36 1/4"	10 1/8"	60"	8 1/2"	3	4	86.3 Lbs.	6 Cu Ft	\$ 2,846	
	DM-6012-S-36-WG	Single Face Starter	37 1/4"	12 1/8"	60"	10 1/2"	3	4	116 Lbs.	8 Cu Ft	\$ 3,265	
	DM-6012-A-36-WG	Single Face Adder	36 1/4"	12 1/8"	60"	10 1/2"	3	4	95.5 Lbs.	7 Cu Ft	\$ 2,884	
	DM-7210-S-24-WG	Single Face Starter	25 1/4"	10 1/8"	72"	8 1/2"	4	5			\$ 3,498	
	DM-7210-A-24-WG	Single Face Adder	24 1/4"	10 1/8"	72"	8 1/2"	4	5			\$ 3,125	
	DM-7212-S-24-WG	Single Face Starter	25 1/4"	12 1/8"	72"	10 1/2"	4	5			\$ 3,560	
	DM-7212-A-24-WG	Single Face Adder	24 1/4"	12 1/8"	72"	10 1/2"	4	5			\$ 3,172	
	DM-7210-S-30-WG	Single Face Starter	31 1/4"	10 1/8"	72"	8 1/2"	4	5			\$ 3,498	
	DM-7210-A-30-WG	Single Face Adder	30 1/4"	10 1/8"	72"	8 1/2"	4	5			\$ 3,125	
	DM-7212-S-30-WG	Single Face Starter	31 1/4"	12 1/8"	72"	10 1/2"	4	5			\$ 3,560	
	DM-7212-A-30-WG	Single Face Adder	30 1/4"	12 1/8"	72"	10 1/2"	4	5			\$ 3,172	
	DM-7210-S-36-WG	Single Face Starter	37 1/4"	10 1/8"	72"	8 1/2"	4	5	115 Lbs.	7 Cu Ft	\$ 3,319	
	DM-7210-A-36-WG	Single Face Adder	36 1/4"	10 1/8"	72"	8 1/2"	4	5	96.6 Lbs.	7 Cu Ft	\$ 2,939	
	DM-7212-S-36-WG	Single Face Starter	37 1/4"	12 1/8"	72"	10 1/2"	4	5	131 Lbs.	8 Cu Ft	\$ 3,382	
	DM-7212-A-36-WG	Single Face Adder	36 1/4"	12 1/8"	72"	10 1/2"	4	5	109 Lbs.	8 Cu Ft	\$ 2,992	





MODEL NUMBER	PRODUCT	WIDTH	DEPTH	HEIGHT	SHELF DEPTH	# OF SHELVES	# OF OPENINGS	WEIGHT	VOLUME	LIST PRICE	DESCRIPTION
 DM-8210-S-24-WG	Single Face Starter	25 1/4"	10 1/8"	82"	8 1/2"	5	6			\$ 3,599	End, Mid, Top and Base Panels to be constructed from 1" thick 11-ply solid core, veneered 2 sides. Vertical, top and bottom edges banded with 1/4" external hardwood edging, edges to be eased. Front Edge: 3/4" thick x 2 1/2" high fascia - tongue and grooved to top.
DM-8210-A-24-WG	Single Face Adder	24 1/4"	10 1/8"	82"	8 1/2"	5	6			\$ 3,234	
DM-8212-S-24-WG	Single Face Starter	25 1/4"	12 1/8"	82"	10 1/2"	5	6			\$ 3,677	
DM-8212-A-24-WG	Single Face Adder	24 1/4"	12 1/8"	82"	10 1/2"	5	6			\$ 3,288	
DM-8210-S-30-WG	Single Face Starter	31 1/4"	10 1/8"	82"	8 1/2"	5	6			\$ 3,599	
DM-8210-A-30-WG	Single Face Adder	30 1/4"	10 1/8"	82"	8 1/2"	5	6			\$ 3,234	
DM-8212-S-30-WG	Single Face Starter	31 1/4"	12 1/8"	82"	10 1/2"	5	6			\$ 3,677	
DM-8212-A-30-WG	Single Face Adder	30 1/4"	12 1/8"	82"	10 1/2"	5	6			\$ 3,288	
DM-8210-S-36-WG	Single Face Starter	37 1/4"	10 1/8"	82"	8 1/2"	5	6	129 Lbs.	8 Cu Ft	\$ 3,428	
DM-8210-A-36-WG	Single Face Adder	36 1/4"	10 1/8"	82"	8 1/2"	5	6	107 Lbs.	7 Cu Ft	\$ 3,056	
DM-8212-S-36-WG	Single Face Starter	37 1/4"	12 1/8"	82"	10 1/2"	5	6	145 Lbs.	9 Cu Ft	\$ 3,490	
DM-8212-A-36-WG	Single Face Adder	36 1/4"	12 1/8"	82"	10 1/2"	5	6	122 Lbs.	8 Cu Ft	\$ 3,102	
 DM-8212-S-36-WG											
 DM-8212-A-36-WG											
DM-9610-S-24-WG	Single Face Starter	25 1/4"	10 1/8"	96"	8 1/2"	6	7			\$ 3,700	
DM-9610-A-24-WG	Single Face Adder	24 1/4"	10 1/8"	96"	8 1/2"	6	7			\$ 3,327	
DM-9612-S-24-WG	Single Face Starter	25 1/4"	12 1/8"	96"	10 1/2"	6	7			\$ 3,786	
DM-9612-A-24-WG	Single Face Adder	24 1/4"	12 1/8"	96"	10 1/2"	6	7			\$ 3,397	
DM-9610-S-30-WG	Single Face Starter	31 1/4"	10 1/8"	96"	8 1/2"	6	7			\$ 3,700	
DM-9610-A-30-WG	Single Face Adder	30 1/4"	10 1/8"	96"	8 1/2"	6	7			\$ 3,327	
DM-9612-S-30-WG	Single Face Starter	31 1/4"	12 1/8"	96"	10 1/2"	6	7			\$ 3,786	
DM-9612-A-30-WG	Single Face Adder	30 1/4"	12 1/8"	96"	10 1/2"	6	7			\$ 3,397	
DM-9610-S-36-WG	Single Face Starter	37 1/4"	10 1/8"	96"	8 1/2"	6	7	156 Lbs.	9 Cu Ft	\$ 3,521	
DM-9610-A-36-WG	Single Face Adder	36 1/4"	10 1/8"	96"	8 1/2"	6	7	128 Lbs.	8 Cu Ft	\$ 3,148	
DM-9612-S-36-WG	Single Face Starter	37 1/4"	12 1/8"	96"	10 1/2"	6	7	177 Lbs.	10 Cu Ft	\$ 3,599	
DM-9612-A-36-WG	Single Face Adder	36 1/4"	12 1/8"	96"	10 1/2"	6	7	145 Lbs.	9 Cu Ft	\$ 3,210	
 DM-9612-S-36-WG											
 DM-9612-A-36-WG											

	MODEL NUMBER	PRODUCT	WIDTH	DEPTH	HEIGHT	SHELF DEPTH	# OF SHELVES	# OF OPENINGS	WEIGHT	VOLUME	LIST PRICE	DESCRIPTION
 Model Shown DM-3624-S-36-WG	DM-3620-S-24-WG	Double Face Starter	25 <sup>1</sup> / <sub>4</sub> "	19 <sup>1</sup> / <sub>2</sub> "	36"	8 <sup>1</sup> / <sub>2</sub> "	2	4			\$ 4,898	End, Mid, Top and Base Panels to be constructed from 1" thick 11-ply solid core, veneered 2 sides. Vertical, top and bottom edges banded with 1/4" external hardwood edging, edges to be eased. Front Edge: 3/4" thick x 2 1/2" high fascia - tongue and grooved to top.
	DM-3620-A-24-WG	Double Face Adder	24 <sup>1</sup> / <sub>4</sub> "	19 <sup>1</sup> / <sub>2</sub> "	36"	8 <sup>1</sup> / <sub>2</sub> "	2	4			\$ 4,253	
	DM-3624-S-24-WG	Double Face Starter	25 <sup>1</sup> / <sub>4</sub> "	23 <sup>1</sup> / <sub>2</sub> "	36"	10 <sup>1</sup> / <sub>2</sub> "	2	4			\$ 4,936	
	DM-3624-A-24-WG	Double Face Adder	24 <sup>1</sup> / <sub>4</sub> "	23 <sup>1</sup> / <sub>2</sub> "	36"	10 <sup>1</sup> / <sub>2</sub> "	2	4			\$ 4,276	
	DM-3620-S-30-WG	Double Face Starter	31 <sup>1</sup> / <sub>4</sub> "	19 <sup>1</sup> / <sub>2</sub> "	36"	8 <sup>1</sup> / <sub>2</sub> "	2	4			\$ 4,898	
	DM-3620-A-30-WG	Double Face Adder	30 <sup>1</sup> / <sub>4</sub> "	19 <sup>1</sup> / <sub>2</sub> "	36"	8 <sup>1</sup> / <sub>2</sub> "	2	4			\$ 4,253	
	DM-3624-S-30-WG	Double Face Starter	31 <sup>1</sup> / <sub>4</sub> "	23 <sup>1</sup> / <sub>2</sub> "	36"	10 <sup>1</sup> / <sub>2</sub> "	2	4			\$ 4,936	
	DM-3624-A-30-WG	Double Face Adder	30 <sup>1</sup> / <sub>4</sub> "	23 <sup>1</sup> / <sub>2</sub> "	36"	10 <sup>1</sup> / <sub>2</sub> "	2	4			\$ 4,276	
 Model Shown DM-3624-A-36-WG	DM-3620-S-36-WG	Double Face Starter	37 <sup>1</sup> / <sub>4</sub> "	19 <sup>1</sup> / <sub>2</sub> "	36"	8 <sup>1</sup> / <sub>2</sub> "	2	4	88.6 Lbs.	7 Cu Ft	\$ 4,626	
	DM-3620-A-36-WG	Double Face Adder	36 <sup>1</sup> / <sub>4</sub> "	19 <sup>1</sup> / <sub>2</sub> "	36"	8 <sup>1</sup> / <sub>2</sub> "	2	4	73.6 Lbs.	6 Cu Ft	\$ 3,973	
	DM-3624-S-36-WG	Double Face Starter	37 <sup>1</sup> / <sub>4</sub> "	23 <sup>1</sup> / <sub>2</sub> "	36"	10 <sup>1</sup> / <sub>2</sub> "	2	4	110 Lbs.	10 Cu Ft	\$ 4,664	
	DM-3624-A-36-WG	Double Face Adder	36 <sup>1</sup> / <sub>4</sub> "	23 <sup>1</sup> / <sub>2</sub> "	36"	10 <sup>1</sup> / <sub>2</sub> "	2	4	88.6 Lbs.	9 Cu Ft	\$ 4,004	
 Model Shown DM-4224-S-36-WG	DM-4220-S-24-WG	Double Face Starter	25 <sup>1</sup> / <sub>4</sub> "	19 <sup>1</sup> / <sub>2</sub> "	42"	8 <sup>1</sup> / <sub>2</sub> "	4	6			\$ 5,106	
	DM-4220-A-24-WG	Double Face Adder	24 <sup>1</sup> / <sub>4</sub> "	19 <sup>1</sup> / <sub>2</sub> "	42"	8 <sup>1</sup> / <sub>2</sub> "	4	6			\$ 4,463	
	DM-4224-S-24-WG	Double Face Starter	25 <sup>1</sup> / <sub>4</sub> "	23 <sup>1</sup> / <sub>2</sub> "	42"	10 <sup>1</sup> / <sub>2</sub> "	4	6			\$ 5,162	
	DM-4224-A-24-WG	Double Face Adder	24 <sup>1</sup> / <sub>4</sub> "	23 <sup>1</sup> / <sub>2</sub> "	42"	10 <sup>1</sup> / <sub>2</sub> "	4	6			\$ 4,493	
	DM-4220-S-30-WG	Double Face Starter	31 <sup>1</sup> / <sub>4</sub> "	19 <sup>1</sup> / <sub>2</sub> "	42"	8 <sup>1</sup> / <sub>2</sub> "	4	6			\$ 5,106	
	DM-4220-A-30-WG	Double Face Adder	30 <sup>1</sup> / <sub>4</sub> "	19 <sup>1</sup> / <sub>2</sub> "	42"	8 <sup>1</sup> / <sub>2</sub> "	4	6			\$ 4,463	
	DM-4224-S-30-WG	Double Face Starter	31 <sup>1</sup> / <sub>4</sub> "	23 <sup>1</sup> / <sub>2</sub> "	42"	10 <sup>1</sup> / <sub>2</sub> "	4	6			\$ 5,162	
	DM-4224-A-30-WG	Double Face Adder	30 <sup>1</sup> / <sub>4</sub> "	23 <sup>1</sup> / <sub>2</sub> "	42"	10 <sup>1</sup> / <sub>2</sub> "	4	6			\$ 4,493	
 Model Shown DM-4224-A-36-WG	DM-4220-S-36-WG	Double Face Starter	37 <sup>1</sup> / <sub>4</sub> "	19 <sup>1</sup> / <sub>2</sub> "	42"	8 <sup>1</sup> / <sub>2</sub> "	4	6	94 Lbs.	7 Cu Ft	\$ 4,836	
	DM-4220-A-36-WG	Double Face Adder	36 <sup>1</sup> / <sub>4</sub> "	19 <sup>1</sup> / <sub>2</sub> "	42"	8 <sup>1</sup> / <sub>2</sub> "	4	6	78 Lbs.	7 Cu Ft	\$ 4,183	
	DM-4224-S-36-WG	Double Face Starter	37 <sup>1</sup> / <sub>4</sub> "	23 <sup>1</sup> / <sub>2</sub> "	42"	10 <sup>1</sup> / <sub>2</sub> "	4	6	115 Lbs.	10 Cu Ft	\$ 4,889	
	DM-4224-A-36-WG	Double Face Adder	36 <sup>1</sup> / <sub>4</sub> "	23 <sup>1</sup> / <sub>2</sub> "	42"	10 <sup>1</sup> / <sub>2</sub> "	4	6	113 Lbs.	10 Cu Ft	\$ 4,222	
 Model Shown DM-4824-A-36-WG	DM-4820-S-24-WG	Double Face Starter	25 <sup>1</sup> / <sub>4</sub> "	19 <sup>1</sup> / <sub>2</sub> "	48"	8 <sup>1</sup> / <sub>2</sub> "	4	6			\$ 5,356	
	DM-4820-A-24-WG	Double Face Adder	24 <sup>1</sup> / <sub>4</sub> "	19 <sup>1</sup> / <sub>2</sub> "	48"	8 <sup>1</sup> / <sub>2</sub> "	4	6			\$ 4,687	
	DM-4824-S-24-WG	Double Face Starter	25 <sup>1</sup> / <sub>4</sub> "	23 <sup>1</sup> / <sub>2</sub> "	48"	10 <sup>1</sup> / <sub>2</sub> "	4	6			\$ 5,418	
	DM-4824-A-24-WG	Double Face Adder	24 <sup>1</sup> / <sub>4</sub> "	23 <sup>1</sup> / <sub>2</sub> "	48"	10 <sup>1</sup> / <sub>2</sub> "	4	6			\$ 4,718	
 Model Shown DM-4824-A-36-WG	DM-4820-S-30-WG	Double Face Starter	31 <sup>1</sup> / <sub>4</sub> "	19 <sup>1</sup> / <sub>2</sub> "	48"	8 <sup>1</sup> / <sub>2</sub> "	4	6			\$ 5,356	
	DM-4820-A-30-WG	Double Face Adder	30 <sup>1</sup> / <sub>4</sub> "	19 <sup>1</sup> / <sub>2</sub> "	48"	8 <sup>1</sup> / <sub>2</sub> "	4	6			\$ 4,687	
	DM-4824-S-30-WG	Double Face Starter	31 <sup>1</sup> / <sub>4</sub> "	23 <sup>1</sup> / <sub>2</sub> "	48"	10 <sup>1</sup> / <sub>2</sub> "	4	6			\$ 5,418	
	DM-4824-A-30-WG	Double Face Adder	30 <sup>1</sup> / <sub>4</sub> "	23 <sup>1</sup> / <sub>2</sub> "	48"	10 <sup>1</sup> / <sub>2</sub> "	4	6			\$ 4,718	
 Model Shown DM-4824-A-36-WG	DM-4820-S-36-WG	Double Face Starter	37 <sup>1</sup> / <sub>4</sub> "	19 <sup>1</sup> / <sub>2</sub> "	48"	8 <sup>1</sup> / <sub>2</sub> "	4	6	132 Lbs.	9 Cu Ft	\$ 5,075	
	DM-4820-A-36-WG	Double Face Adder	36 <sup>1</sup> / <sub>4</sub> "	19 <sup>1</sup> / <sub>2</sub> "	48"	8 <sup>1</sup> / <sub>2</sub> "	4	6	109 Lbs.	8 Cu Ft	\$ 4,392	
	DM-4824-S-36-WG	Double Face Starter	37 <sup>1</sup> / <sub>4</sub> "	23 <sup>1</sup> / <sub>2</sub> "	48"	10 <sup>1</sup> / <sub>2</sub> "	4	6	155 Lbs.	11 Cu Ft	\$ 5,130	
	DM-4824-A-36-WG	Double Face Adder	36 <sup>1</sup> / <sub>4</sub> "	23 <sup>1</sup> / <sub>2</sub> "	48"	10 <sup>1</sup> / <sub>2</sub> "	4	6	127 Lbs.	10 Cu Ft	\$ 4,439	

	MODEL NUMBER	PRODUCT	WIDTH	DEPTH	HEIGHT	SHELF DEPTH	# OF SHELVES	# OF OPENINGS	WEIGHT	VOLUME	LIST PRICE	DESCRIPTION
	DM-6020-S-24-WG	Double Face Starter	25 1/4"	19 1/2"	60"	8 1/2"	6	8			\$ 6,816	End, Mid, Top and Base Panels to be constructed from 1" thick 11-ply solid core, veneered 2 sides. Vertical, top and bottom edges banded with 1/4" external hardwood edging, edges to be eased. Front Edge: 3/4" thick x 2 1/2" high fascia - tongue and grooved to top.
	DM-6020-A-24-WG	Double Face Adder	24 1/4"	19 1/2"	60"	8 1/2"	6	8			\$ 6,141	
	DM-6024-S-24-WG	Double Face Starter	25 1/4"	23 1/2"	60"	10 1/2"	6	8			\$ 6,872	
	DM-6024-A-24-WG	Double Face Adder	24 1/4"	23 1/2"	60"	10 1/2"	6	8			\$ 6,195	
	DM-6020-S-30-WG	Double Face Starter	31 1/4"	19 1/2"	60"	8 1/2"	6	8			\$ 6,816	
	DM-6020-A-30-WG	Double Face Adder	30 1/4"	19 1/2"	60"	8 1/2"	6	8			\$ 6,141	
	DM-6024-S-30-WG	Double Face Starter	31 1/4"	23 1/2"	60"	10 1/2"	6	8			\$ 6,872	
	DM-6024-A-30-WG	Double Face Adder	30 1/4"	23 1/2"	60"	10 1/2"	6	8			\$ 6,195	
	DM-6020-S-36-WG	Double Face Starter	37 1/4"	19 1/2"	60"	8 1/2"	6	8	176 Lbs.	11 Cu Ft	\$ 6,538	
	DM-6020-A-36-WG	Double Face Adder	36 1/4"	19 1/2"	60"	8 1/2"	6	8	145 Lbs.	10 Cu Ft	\$ 5,877	
	DM-6024-S-36-WG	Double Face Starter	37 1/4"	23 1/2"	60"	10 1/2"	6	8	200 Lbs.	12 Cu Ft	\$ 6,599	
	DM-6024-A-36-WG	Double Face Adder	36 1/4"	23 1/2"	60"	10 1/2"	6	8	164 Lbs.	11 Cu Ft	\$ 5,924	
	DM-7220-S-24-WG	Double Face Starter	25 1/4"	19 1/2"	72"	8 1/2"	8	10			\$ 7,020	
	DM-7220-A-24-WG	Double Face Adder	24 1/4"	19 1/2"	72"	8 1/2"	8	10			\$ 6,350	
	DM-7224-S-24-WG	Double Face Starter	25 1/4"	23 1/2"	72"	10 1/2"	8	10			\$ 7,090	
	DM-7224-A-24-WG	Double Face Adder	24 1/4"	23 1/2"	72"	10 1/2"	8	10			\$ 6,414	
	DM-7220-S-30-WG	Double Face Starter	31 1/4"	19 1/2"	72"	8 1/2"	8	10			\$ 7,020	
	DM-7220-A-30-WG	Double Face Adder	30 1/4"	19 1/2"	72"	8 1/2"	8	10			\$ 6,350	
	DM-7224-S-30-WG	Double Face Starter	31 1/4"	23 1/2"	72"	10 1/2"	8	10			\$ 7,090	
	DM-7224-A-30-WG	Double Face Adder	30 1/4"	23 1/2"	72"	10 1/2"	8	10			\$ 6,414	
	DM-7220-S-36-WG	Double Face Starter	37 1/4"	19 1/2"	72"	8 1/2"	8	10	200 Lbs.	12 Cu Ft	\$ 6,755	
	DM-7220-A-36-WG	Double Face Adder	36 1/4"	19 1/2"	72"	8 1/2"	8	10	164 Lbs.	11 Cu Ft	\$ 6,080	
	DM-7224-S-36-WG	Double Face Starter	37 1/4"	23 1/2"	72"	10 1/2"	8	10	229 Lbs.	13 Cu Ft	\$ 6,816	
	DM-7224-A-36-WG	Double Face Adder	36 1/4"	23 1/2"	72"	10 1/2"	8	10	186 Lbs.	12 Cu Ft	\$ 6,141	

	MODEL NUMBER	PRODUCT	WIDTH	DEPTH	HEIGHT	SHELF DEPTH	# OF SHELVES	# OF OPENINGS	WEIGHT	VOLUME	LIST PRICE	DESCRIPTION
	DM-8220-S-24-WG	Double Face Starter	25 1/4"	19 1/2"	82"	8 1/2"	10	12			\$ 7,221	End, Mid, Top and Base Panels to be constructed from 1" thick 11-ply solid core, veneered 2 sides. Vertical, top and bottom edges banded with 1/4" external hardwood edging, edges to be eased. Front Edge: 3/4" thick x 2 1/2" high fascia - tongue and grooved to top.
	DM-8220-A-24-WG	Double Face Adder	24 1/4"	19 1/2"	82"	8 1/2"	10	12			\$ 6,561	
	DM-8224-S-24-WG	Double Face Starter	25 1/4"	23 1/2"	82"	10 1/2"	10	12			\$ 7,299	
	DM-8224-A-24-WG	Double Face Adder	24 1/4"	23 1/2"	82"	10 1/2"	10	12			\$ 6,646	
	DM-8220-S-30-WG	Double Face Starter	31 1/4"	19 1/2"	82"	8 1/2"	10	12			\$ 7,221	
	DM-8220-A-30-WG	Double Face Adder	30 1/4"	19 1/2"	82"	8 1/2"	10	12			\$ 6,561	
	DM-8224-S-30-WG	Double Face Starter	31 1/4"	23 1/2"	82"	10 1/2"	10	12			\$ 7,299	
	DM-8224-A-30-WG	Double Face Adder	30 1/4"	23 1/2"	82"	10 1/2"	10	12			\$ 6,646	
	DM-8220-S-36-WG	Double Face Starter	37 1/4"	19 1/2"	82"	8 1/2"	10	12	224 Lbs.	12 Cu Ft	\$ 6,951	
	DM-8220-A-36-WG	Double Face Adder	36 1/4"	19 1/2"	82"	8 1/2"	10	12	184 Lbs.	11 Cu Ft	\$ 6,288	
	DM-8224-S-36-WG	Double Face Starter	37 1/4"	23 1/2"	82"	10 1/2"	10	12	256 Lbs.	14 Cu Ft	\$ 7,020	
	DM-8224-A-36-WG	Double Face Adder	36 1/4"	23 1/2"	82"	10 1/2"	10	12	207 Lbs.	12 Cu Ft	\$ 6,368	
	DM-9620-S-24-WG	Double Face Starter	25 1/4"	19 1/2"	96"	8 1/2"	12	14			\$ 7,423	
	DM-9620-A-24-WG	Double Face Adder	24 1/4"	19 1/2"	96"	8 1/2"	12	14			\$ 6,763	
	DM-9624-S-24-WG	Double Face Starter	25 1/4"	23 1/2"	96"	10 1/2"	12	14			\$ 7,516	
	DM-9624-A-24-WG	Double Face Adder	24 1/4"	23 1/2"	96"	10 1/2"	12	14			\$ 6,864	
	DM-9620-S-30-WG	Double Face Starter	31 1/4"	19 1/2"	96"	8 1/2"	12	14			\$ 7,423	
	DM-9620-A-30-WG	Double Face Adder	30 1/4"	19 1/2"	96"	8 1/2"	12	14			\$ 6,763	
	DM-9624-S-30-WG	Double Face Starter	31 1/4"	23 1/2"	96"	10 1/2"	12	14			\$ 7,516	
	DM-9624-A-30-WG	Double Face Adder	30 1/4"	23 1/2"	96"	10 1/2"	12	14			\$ 6,864	
	DM-9620-S-36-WG	Double Face Starter	37 1/4"	19 1/2"	96"	8 1/2"	12	14	276 Lbs.	13 Cu Ft	\$ 7,159	
	DM-9620-A-36-WG	Double Face Adder	36 1/4"	19 1/2"	96"	8 1/2"	12	14	220 Lbs.	12 Cu Ft	\$ 6,492	
	DM-9624-S-36-WG	Double Face Starter	37 1/4"	23 1/2"	96"	10 1/2"	12	14	315 Lbs.	15 Cu Ft	\$ 7,252	
	DM-9624-A-36-WG	Double Face Adder	36 1/4"	23 1/2"	96"	10 1/2"	12	14	247 Lbs.	13 Cu Ft	\$ 6,585	

	MODEL NUMBER	PRODUCT	WIDTH	DEPTH	HEIGHT	SHELF DEPTH	# OF SHELVES	# OF OPENINGS	WEIGHT	VOLUME	LIST PRICE	DESCRIPTION
 Model Shown DM-3612-S-36-WH	DM-3610-S-24-WH	Single Face Starter	25 1/4"	10 1/8"	36"	8 1/2"	1	2			\$ 2,535	End, Mid, Top and Base Panels to be constructed from 1" thick 11-ply solid core, veneered 2 sides. Vertical, top and bottom edges banded with 1/4" external hardwood edging, edges to be eased. Front Edge: 3/4" thick x 2 1/2" high fascia - tongue and grooved to top.
	DM-3610-A-24-WH	Single Face Adder	24 1/4"	10 1/8"	36"	8 1/2"	1	2			\$ 2,162	
	DM-3612-S-24-WH	Single Face Starter	25 1/4"	12 1/8"	36"	10 1/2"	1	2			\$ 2,581	
	DM-3612-A-24-WH	Single Face Adder	24 1/4"	12 1/8"	36"	10 1/2"	1	2			\$ 2,200	
 Model Shown DM-3612-A-36-WH	DM-3610-S-30-WH	Single Face Starter	31 1/4"	10 1/8"	36"	8 1/2"	1	2			\$ 2,535	
	DM-3610-A-30-WH	Single Face Adder	30 1/4"	10 1/8"	36"	8 1/2"	1	2			\$ 2,162	
	DM-3612-S-30-WH	Single Face Starter	31 1/4"	12 1/8"	36"	10 1/2"	1	2			\$ 2,581	
	DM-3612-A-30-WH	Single Face Adder	30 1/4"	12 1/8"	36"	10 1/2"	1	2			\$ 2,200	
	DM-3610-S-36-WH	Single Face Starter	37 1/4"	10 1/8"	36"	8 1/2"	1	2	50.6 Lbs.	4 Cu Ft	\$ 2,356	
	DM-3610-A-36-WH	Single Face Adder	36 1/4"	10 1/8"	36"	8 1/2"	1	2	46 Lbs.	4 Cu Ft	\$ 1,983	
	DM-3612-S-36-WH	Single Face Starter	37 1/4"	12 1/8"	36"	10 1/2"	1	2	50.6 Lbs.	5 Cu Ft	\$ 2,401	
	DM-3612-A-36-WH	Single Face Adder	36 1/4"	12 1/8"	36"	10 1/2"	1	2	47.2 Lbs.	5 Cu Ft	\$ 2,014	
 Model Shown DM-4212-S-36-WH	DM-4210-S-24-WH	Single Face Starter	25 1/4"	10 1/8"	42"	8 1/2"	2	3			\$ 2,643	
	DM-4210-A-24-WH	Single Face Adder	24 1/4"	10 1/8"	42"	8 1/2"	2	3			\$ 2,277	
	DM-4212-S-24-WH	Single Face Starter	25 1/4"	12 1/8"	42"	10 1/2"	2	3			\$ 2,698	
	DM-4212-A-24-WH	Single Face Adder	24 1/4"	12 1/8"	42"	10 1/2"	2	3			\$ 2,309	
 Model Shown DM-4212-A-36-WH	DM-4210-S-30-WH	Single Face Starter	31 1/4"	10 1/8"	42"	8 1/2"	2	3			\$ 2,643	
	DM-4210-A-30-WH	Single Face Adder	30 1/4"	10 1/8"	42"	8 1/2"	2	3			\$ 2,277	
	DM-4212-S-30-WH	Single Face Starter	31 1/4"	12 1/8"	42"	10 1/2"	2	3			\$ 2,698	
	DM-4212-A-30-WH	Single Face Adder	30 1/4"	12 1/8"	42"	10 1/2"	2	3			\$ 2,309	
 Model Shown DM-4212-A-36-WH	DM-4210-S-36-WH	Single Face Starter	37 1/4"	10 1/8"	42"	8 1/2"	2	3	55 Lbs.	5 Cu Ft	\$ 2,456	
	DM-4210-A-36-WH	Single Face Adder	36 1/4"	10 1/8"	42"	8 1/2"	2	3	52 Lbs.	5 Cu Ft	\$ 2,100	
	DM-4212-S-36-WH	Single Face Starter	37 1/4"	12 1/8"	42"	10 1/2"	2	3	60 Lbs.	5 Cu Ft	\$ 2,512	
	DM-4212-A-36-WH	Single Face Adder	36 1/4"	12 1/8"	42"	10 1/2"	2	3	53 Lbs.	5 Cu Ft	\$ 2,122	
	DM-4810-S-24-WH	Single Face Starter	25 1/4"	10 1/8"	48"	8 1/2"	2	3			\$ 2,712	
	DM-4810-A-24-WH	Single Face Adder	24 1/4"	10 1/8"	48"	8 1/2"	2	3			\$ 2,332	
	DM-4812-S-24-WH	Single Face Starter	25 1/4"	12 1/8"	48"	10 1/2"	2	3			\$ 2,736	
	DM-4812-A-24-WH	Single Face Adder	24 1/4"	12 1/8"	48"	10 1/2"	2	3			\$ 2,332	
	DM-4810-S-30-WH	Single Face Starter	31 1/4"	10 1/8"	48"	8 1/2"	2	3			\$ 2,712	
	DM-4810-A-30-WH	Single Face Adder	30 1/4"	10 1/8"	48"	8 1/2"	2	3			\$ 2,332	
	DM-4812-S-30-WH	Single Face Starter	31 1/4"	12 1/8"	48"	10 1/2"	2	3			\$ 2,736	
	DM-4812-A-30-WH	Single Face Adder	30 1/4"	12 1/8"	48"	10 1/2"	2	3			\$ 2,332	
	DM-4810-S-36-WH	Single Face Starter	37 1/4"	10 1/8"	48"	8 1/2"	2	3	74.8 Lbs.	5 Cu Ft	\$ 2,535	
	DM-4810-A-36-WH	Single Face Adder	36 1/4"	10 1/8"	48"	8 1/2"	2	3	65.5 Lbs.	5 Cu Ft	\$ 2,146	
	DM-4812-S-36-WH	Single Face Starter	37 1/4"	12 1/8"	48"	10 1/2"	2	3	82.8 Lbs.	6 Cu Ft	\$ 2,551	
	DM-4812-A-36-WH	Single Face Adder	36 1/4"	12 1/8"	48"	10 1/2"	2	3	71.3 Lbs.	6 Cu Ft	\$ 2,146	

MODEL NUMBER	PRODUCT	WIDTH	DEPTH	HEIGHT	SHELF DEPTH	# OF SHELVES	# OF OPENINGS	WEIGHT	VOLUME	LIST PRICE	DESCRIPTION
 Model Shown DM-6012-S-36-WH	DM-6010-S-24-WH	Single Face Starter	25 1/4"	10 1/8"	60"	8 1/2"	3			\$ 2,946	End, Mid, Top and Base Panels to be constructed from 1" thick 11-ply solid core, veneered 2 sides. Vertical, top and bottom edges banded with 1/4" external hardwood edging, edges to be eased. Front Edge: 3/4" thick x 2 1/2" high fascia - tongue and grooved to top.
	DM-6010-A-24-WH	Single Face Adder	24 1/4"	10 1/8"	60"	8 1/2"	3			\$ 2,581	
	DM-6012-S-24-WH	Single Face Starter	25 1/4"	12 1/8"	60"	10 1/2"	3			\$ 3,010	
	DM-6012-A-24-WH	Single Face Adder	24 1/4"	12 1/8"	60"	10 1/2"	3			\$ 2,619	
 Model Shown DM-6012-A-36-WH	DM-6010-S-30-WH	Single Face Starter	31 1/4"	10 1/8"	60"	8 1/2"	3			\$ 2,946	
	DM-6010-A-30-WH	Single Face Adder	30 1/4"	10 1/8"	60"	8 1/2"	3			\$ 2,581	
	DM-6012-S-30-WH	Single Face Starter	31 1/4"	12 1/8"	60"	10 1/2"	3			\$ 3,010	
	DM-6012-A-30-WH	Single Face Adder	30 1/4"	12 1/8"	60"	10 1/2"	3			\$ 2,619	
 Model Shown DM-6012-A-36-WH	DM-6010-S-36-WH	Single Face Starter	37 1/4"	10 1/8"	60"	8 1/2"	3			\$ 2,768	
	DM-6010-A-36-WH	Single Face Adder	36 1/4"	10 1/8"	60"	8 1/2"	3	100 Lbs.	6 Cu Ft	\$ 2,401	
	DM-6012-S-36-WH	Single Face Starter	37 1/4"	12 1/8"	60"	10 1/2"	3	86.3 Lbs.	6 Cu Ft	\$ 2,822	
	DM-6012-A-36-WH	Single Face Adder	36 1/4"	12 1/8"	60"	10 1/2"	3	116 Lbs.	8 Cu Ft	\$ 2,822	
 Model Shown DM-7212-S-36-WH	DM-7210-S-24-WH	Single Face Starter	25 1/4"	10 1/8"	72"	8 1/2"	4			\$ 3,056	
	DM-7210-A-24-WH	Single Face Adder	24 1/4"	10 1/8"	72"	8 1/2"	4			\$ 2,682	
	DM-7212-S-24-WH	Single Face Starter	25 1/4"	12 1/8"	72"	10 1/2"	4			\$ 3,125	
	DM-7212-A-24-WH	Single Face Adder	24 1/4"	12 1/8"	72"	10 1/2"	4			\$ 2,736	
 Model Shown DM-7212-S-36-WH	DM-7210-S-30-WH	Single Face Starter	31 1/4"	10 1/8"	72"	8 1/2"	4			\$ 3,056	
	DM-7210-A-30-WH	Single Face Adder	30 1/4"	10 1/8"	72"	8 1/2"	4			\$ 2,682	
	DM-7212-S-30-WH	Single Face Starter	31 1/4"	12 1/8"	72"	10 1/2"	4			\$ 3,125	
	DM-7212-A-30-WH	Single Face Adder	30 1/4"	12 1/8"	72"	10 1/2"	4			\$ 2,729	
 Model Shown DM-7212-A-36-WH	DM-7210-S-36-WH	Single Face Starter	37 1/4"	10 1/8"	72"	8 1/2"	4			\$ 2,876	
	DM-7210-A-36-WH	Single Face Adder	36 1/4"	10 1/8"	72"	8 1/2"	4	115 Lbs.	7 Cu Ft	\$ 2,504	
	DM-7212-S-36-WH	Single Face Starter	37 1/4"	12 1/8"	72"	10 1/2"	4	96.6 Lbs.	7 Cu Ft	\$ 2,939	
	DM-7212-A-36-WH	Single Face Adder	36 1/4"	12 1/8"	72"	10 1/2"	4	131 Lbs.	8 Cu Ft	\$ 2,551	

MODEL NUMBER	PRODUCT	WIDTH	DEPTH	HEIGHT	SHELF DEPTH	# OF SHELVES	# OF OPENINGS	WEIGHT	VOLUME	LIST PRICE	DESCRIPTION
DM-8210-S-24-WH	Single Face Starter	25 1/4"	10 1/8"	82"	8 1/2"	5	6			\$ 3,157	End, Mid, Top and Base Panels to be constructed from 1" thick 11-ply solid core, veneered 2 sides. Vertical, top and bottom edges banded with 1/4" external hardwood edging, edges to be eased. Front Edge: 3/4" thick x 2 1/2" high fascia - tongue and grooved to top.
DM-8210-A-24-WH	Single Face Adder	24 1/4"	10 1/8"	82"	8 1/2"	5	6			\$ 2,783	
DM-8212-S-24-WH	Single Face Starter	25 1/4"	12 1/8"	82"	10 1/2"	5	6			\$ 3,234	
DM-8212-A-24-WH	Single Face Adder	24 1/4"	12 1/8"	82"	10 1/2"	5	6			\$ 2,846	
DM-8210-S-30-WH	Single Face Starter	31 1/4"	10 1/8"	82"	8 1/2"	5	6			\$ 3,157	
DM-8210-A-30-WH	Single Face Adder	30 1/4"	10 1/8"	82"	8 1/2"	5	6			\$ 2,783	
DM-8212-S-30-WH	Single Face Starter	31 1/4"	12 1/8"	82"	10 1/2"	5	6			\$ 3,234	
DM-8212-A-30-WH	Single Face Adder	30 1/4"	12 1/8"	82"	10 1/2"	5	6			\$ 2,846	
DM-8210-S-36-WH	Single Face Starter	37 1/4"	10 1/8"	82"	8 1/2"	5	6	129 Lbs.	8 Cu Ft	\$ 2,977	
DM-8210-A-36-WH	Single Face Adder	36 1/4"	10 1/8"	82"	8 1/2"	5	6	107 Lbs.	7 Cu Ft	\$ 2,605	
DM-8212-S-36-WH	Single Face Starter	37 1/4"	12 1/8"	82"	10 1/2"	5	6	145 Lbs.	9 Cu Ft	\$ 3,047	
DM-8212-A-36-WH	Single Face Adder	36 1/4"	12 1/8"	82"	10 1/2"	5	6	122 Lbs.	8 Cu Ft	\$ 2,666	
DM-9610-S-24-WH	Single Face Starter	25 1/4"	10 1/8"	96"	8 1/2"	6	7			\$ 3,258	
DM-9610-A-24-WH	Single Face Adder	24 1/4"	10 1/8"	96"	8 1/2"	6	7			\$ 2,892	
DM-9612-S-24-WH	Single Face Starter	25 1/4"	12 1/8"	96"	10 1/2"	6	7			\$ 3,343	
DM-9612-A-24-WH	Single Face Adder	24 1/4"	12 1/8"	96"	10 1/2"	6	7			\$ 2,946	
DM-9610-S-30-WH	Single Face Starter	31 1/4"	10 1/8"	96"	8 1/2"	6	7			\$ 3,258	
DM-9610-A-30-WH	Single Face Adder	30 1/4"	10 1/8"	96"	8 1/2"	6	7			\$ 2,892	
DM-9612-S-30-WH	Single Face Starter	31 1/4"	12 1/8"	96"	10 1/2"	6	7			\$ 3,343	
DM-9612-A-30-WH	Single Face Adder	30 1/4"	12 1/8"	96"	10 1/2"	6	7			\$ 2,946	
DM-9610-S-36-WH	Single Face Starter	37 1/4"	10 1/8"	96"	8 1/2"	6	7	156 Lbs.	9 Cu Ft	\$ 3,077	
DM-9610-A-36-WH	Single Face Adder	36 1/4"	10 1/8"	96"	8 1/2"	6	7	128 Lbs.	8 Cu Ft	\$ 2,705	
DM-9612-S-36-WH	Single Face Starter	37 1/4"	12 1/8"	96"	10 1/2"	6	7	177 Lbs.	10 Cu Ft	\$ 3,164	
DM-9612-A-36-WH	Single Face Adder	36 1/4"	12 1/8"	96"	10 1/2"	6	7	145 Lbs.	9 Cu Ft	\$ 2,768	



Model Shown  
DM-8212-S-36-WH



Model Shown  
DM-8212-A-36-WH















Model Shown  
DM-9612-S-36-WH













Model Shown  
DM-9612-A-36-WH









	MODEL NUMBER	PRODUCT	WIDTH	DEPTH	HEIGHT	SHELF DEPTH	# OF SHELVES	# OF OPENINGS	WEIGHT	VOLUME	LIST PRICE	DESCRIPTION
 <p>Model Shown DM-3624-S-36-WH</p>	DM-3620-S-24-WH	Double Face Starter	25 1/4"	19 1/2"	36"	8 1/2"	2	4			\$ 4,751	End, Mid, Top and Base Panels to be constructed from 1" thick 11-ply solid core, veneered 2 sides. Vertical, top and bottom edges banded with 1/4" external hardwood edging, edges to be eased. Front Edge: 3/4" thick x 2 1/2" high fascia - tongue and grooved to top.
	DM-3620-A-24-WH	Double Face Adder	24 1/4"	19 1/2"	36"	8 1/2"	2	4			\$ 4,111	
	DM-3624-S-24-WH	Double Face Starter	25 1/4"	23 1/2"	36"	10 1/2"	2	4			\$ 4,797	
	DM-3624-A-24-WH	Double Face Adder	24 1/4"	23 1/2"	36"	10 1/2"	2	4			\$ 4,135	
 <p>Model Shown DM-3624-S-30-WH</p>	DM-3620-S-30-WH	Double Face Starter	31 1/4"	19 1/2"	36"	8 1/2"	2	4			\$ 4,751	
	DM-3620-A-30-WH	Double Face Adder	30 1/4"	19 1/2"	36"	8 1/2"	2	4			\$ 4,111	
	DM-3624-S-30-WH	Double Face Starter	31 1/4"	23 1/2"	36"	10 1/2"	2	4			\$ 4,797	
	DM-3624-A-30-WH	Double Face Adder	30 1/4"	23 1/2"	36"	10 1/2"	2	4			\$ 4,135	
 <p>Model Shown DM-3624-A-36-WH</p>	DM-3620-S-36-WH	Double Face Starter	37 1/4"	19 1/2"	36"	8 1/2"	2	4	88.6 Lbs.	7 Cu Ft	\$ 4,485	
	DM-3620-A-36-WH	Double Face Adder	36 1/4"	19 1/2"	36"	8 1/2"	2	4	73.6 Lbs.	6 Cu Ft	\$ 3,841	
	DM-3624-S-36-WH	Double Face Starter	37 1/4"	23 1/2"	36"	10 1/2"	2	4	110 Lbs.	10 Cu Ft	\$ 4,524	
	DM-3624-A-36-WH	Double Face Adder	36 1/4"	23 1/2"	36"	10 1/2"	2	4	88.6 Lbs.	9 Cu Ft	\$ 3,863	
 <p>Model Shown DM-4224-S-36-WH</p>	DM-4220-S-24-WH	Double Face Starter	25 1/4"	19 1/2"	42"	8 1/2"	4	6			\$ 4,968	
	DM-4220-A-24-WH	Double Face Adder	24 1/4"	19 1/2"	42"	8 1/2"	4	6			\$ 4,322	
	DM-4224-S-24-WH	Double Face Starter	25 1/4"	23 1/2"	42"	10 1/2"	4	6			\$ 5,029	
	DM-4224-A-24-WH	Double Face Adder	24 1/4"	23 1/2"	42"	10 1/2"	4	6			\$ 4,353	
 <p>Model Shown DM-4224-S-30-WH</p>	DM-4220-S-30-WH	Double Face Starter	31 1/4"	19 1/2"	42"	8 1/2"	4	6			\$ 4,968	
	DM-4220-A-30-WH	Double Face Adder	30 1/4"	19 1/2"	42"	8 1/2"	4	6			\$ 4,322	
	DM-4224-S-30-WH	Double Face Starter	31 1/4"	23 1/2"	42"	10 1/2"	4	6			\$ 5,029	
	DM-4224-A-30-WH	Double Face Adder	30 1/4"	23 1/2"	42"	10 1/2"	4	6			\$ 4,353	
 <p>Model Shown DM-4224-A-36-WH</p>	DM-4220-S-36-WH	Double Face Starter	37 1/4"	19 1/2"	42"	8 1/2"	4	6	94 Lbs.	7 Cu Ft	\$ 4,694	
	DM-4220-A-36-WH	Double Face Adder	36 1/4"	19 1/2"	42"	8 1/2"	4	6	78 Lbs.	7 Cu Ft	\$ 4,050	
	DM-4224-S-36-WH	Double Face Starter	37 1/4"	23 1/2"	42"	10 1/2"	4	6	115 Lbs.	10 Cu Ft	\$ 4,751	
	DM-4224-A-36-WH	Double Face Adder	36 1/4"	23 1/2"	42"	10 1/2"	4	6	113 Lbs.	10 Cu Ft	\$ 4,080	
 <p>Model Shown DM-4824-S-36-WH</p>	DM-4820-S-24-WH	Double Face Starter	25 1/4"	19 1/2"	48"	8 1/2"	4	6			\$ 5,061	
	DM-4820-A-24-WH	Double Face Adder	24 1/4"	19 1/2"	48"	8 1/2"	4	6			\$ 4,392	
	DM-4824-S-24-WH	Double Face Starter	25 1/4"	23 1/2"	48"	10 1/2"	4	6			\$ 5,115	
	DM-4824-A-24-WH	Double Face Adder	24 1/4"	23 1/2"	48"	10 1/2"	4	6			\$ 4,423	
 <p>Model Shown DM-4824-S-30-WH</p>	DM-4820-S-30-WH	Double Face Starter	31 1/4"	19 1/2"	48"	8 1/2"	4	6			\$ 5,061	
	DM-4820-A-30-WH	Double Face Adder	30 1/4"	19 1/2"	48"	8 1/2"	4	6			\$ 4,392	
	DM-4824-S-30-WH	Double Face Starter	31 1/4"	23 1/2"	48"	10 1/2"	4	6			\$ 5,115	
	DM-4824-A-30-WH	Double Face Adder	30 1/4"	23 1/2"	48"	10 1/2"	4	6			\$ 4,423	
 <p>Model Shown DM-4824-A-36-WH</p>	DM-4820-S-36-WH	Double Face Starter	37 1/4"	19 1/2"	48"	8 1/2"	4	6	132 Lbs.	9 Cu Ft	\$ 4,781	
	DM-4820-A-36-WH	Double Face Adder	36 1/4"	19 1/2"	48"	8 1/2"	4	6	109 Lbs.	8 Cu Ft	\$ 4,120	
	DM-4824-S-36-WH	Double Face Starter	37 1/4"	23 1/2"	48"	10 1/2"	4	6	155 Lbs.	11 Cu Ft	\$ 4,844	
	DM-4824-A-36-WH	Double Face Adder	36 1/4"	23 1/2"	48"	10 1/2"	4	6	127 Lbs.	10 Cu Ft	\$ 4,143	

	MODEL NUMBER	PRODUCT	WIDTH	DEPTH	HEIGHT	SHELF DEPTH	# OF SHELVES	# OF OPENINGS	WEIGHT	VOLUME	LIST PRICE	DESCRIPTION	
 <p>Model Shown DM-6024-S-36-WH</p>	DM-6020-S-24-WH	Double Face Starter	25 1/4"	19 1/2"	60"	8 1/2"	6	8			\$ 5,558	End, Mid, Top and Base Panels to be constructed from 1" thick 11-ply solid core, veneered 2 sides. Vertical, top and bottom edges banded with 1/4" external hardwood edging, edges to be eased. Front Edge: 3/4" thick x 2 1/2" high fascia - tongue and grooved to top.	
	DM-6020-A-24-WH	Double Face Adder	24 1/4"	19 1/2"	60"	8 1/2"	6	8			\$ 4,898		
	DM-6024-S-24-WH	Double Face Starter	25 1/4"	23 1/2"	60"	10 1/2"	6	8			\$ 5,621		
	DM-6024-A-24-WH	Double Face Adder	24 1/4"	23 1/2"	60"	10 1/2"	6	8			\$ 4,944		
	DM-6020-S-30-WH	Double Face Starter	31 1/4"	19 1/2"	60"	8 1/2"	6	8			\$ 5,558		
	DM-6020-A-30-WH	Double Face Adder	30 1/4"	19 1/2"	60"	8 1/2"	6	8			\$ 4,898		
	DM-6024-S-30-WH	Double Face Starter	31 1/4"	23 1/2"	60"	10 1/2"	6	8			\$ 5,621		
	DM-6024-A-30-WH	Double Face Adder	30 1/4"	23 1/2"	60"	10 1/2"	6	8			\$ 4,944		
	DM-6020-S-36-WH	Double Face Starter	37 1/4"	19 1/2"	60"	8 1/2"	6	8	176 Lbs.	11 Cu Ft	\$ 6,538		
	DM-6020-A-36-WH	Double Face Adder	36 1/4"	19 1/2"	60"	8 1/2"	6	8	145 Lbs.	10 Cu Ft	\$ 5,877		
	DM-6024-S-36-WH	Double Face Starter	37 1/4"	23 1/2"	60"	10 1/2"	6	8	200 Lbs.	12 Cu Ft	\$ 6,599		
	DM-6024-A-36-WH	Double Face Adder	36 1/4"	23 1/2"	60"	10 1/2"	6	8	164 Lbs.	11 Cu Ft	\$ 5,924		
 <p>Model Shown DM-6024-A-36-WH</p>													
 <p>Model Shown DM-7224-S-36-WH</p>	DM-7220-S-24-WH	Double Face Starter	25 1/4"	19 1/2"	72"	8 1/2"	8	10			\$ 5,768		
	DM-7220-A-24-WH	Double Face Adder	24 1/4"	19 1/2"	72"	8 1/2"	8	10			\$ 5,099		
	DM-7224-S-24-WH	Double Face Starter	25 1/4"	23 1/2"	72"	10 1/2"	8	10			\$ 5,839		
	DM-7224-A-24-WH	Double Face Adder	24 1/4"	23 1/2"	72"	10 1/2"	8	10			\$ 5,162		
	DM-7220-S-30-WH	Double Face Starter	31 1/4"	19 1/2"	72"	8 1/2"	8	10			\$ 5,768		
	DM-7220-A-30-WH	Double Face Adder	30 1/4"	19 1/2"	72"	8 1/2"	8	10			\$ 5,099		
	DM-7224-S-30-WH	Double Face Starter	31 1/4"	23 1/2"	72"	10 1/2"	8	10			\$ 5,839		
	DM-7224-A-30-WH	Double Face Adder	30 1/4"	23 1/2"	72"	10 1/2"	8	10			\$ 5,162		
	DM-7220-S-36-WH	Double Face Starter	37 1/4"	19 1/2"	72"	8 1/2"	8	10	200 Lbs.	12 Cu Ft	\$ 5,497		
	DM-7220-A-36-WH	Double Face Adder	36 1/4"	19 1/2"	72"	8 1/2"	8	10	164 Lbs.	11 Cu Ft	\$ 4,827		
	DM-7224-S-36-WH	Double Face Starter	37 1/4"	23 1/2"	72"	10 1/2"	8	10	229 Lbs.	13 Cu Ft	\$ 5,558		
	DM-7224-A-36-WH	Double Face Adder	36 1/4"	23 1/2"	72"	10 1/2"	8	10	186 Lbs.	12 Cu Ft	\$ 4,889		
 <p>Model Shown DM-7224-A-36-WH</p>													

MODEL NUMBER	PRODUCT	WIDTH	DEPTH	HEIGHT	SHELF DEPTH	# OF SHELVES	# OF OPENINGS	WEIGHT	VOLUME	LIST PRICE	DESCRIPTION
 Model Shown DM-8224-S-36-WH	DM-8220-S-24-WH	Double Face Starter	25 1/4"	19 1/2"	82"	8 1/2"	10			\$ 5,970	End, Mid, Top and Base Panels to be constructed from 1" thick 11-ply solid core, veneered 2 sides. Vertical, top and bottom edges banded with 1/4" external hardwood edging, edges to be eased. Front Edge: 3/4" thick x 2 1/2" high fascia - tongue and grooved to top.
	DM-8220-A-24-WH	Double Face Adder	24 1/4"	19 1/2"	82"	8 1/2"	10			\$ 5,303	
	DM-8224-S-24-WH	Double Face Starter	25 1/4"	23 1/2"	82"	10 1/2"	10			\$ 6,048	
	DM-8224-A-24-WH	Double Face Adder	24 1/4"	23 1/2"	82"	10 1/2"	10			\$ 5,387	
 Model Shown DM-8224-A-36-WH	DM-8220-S-30-WH	Double Face Starter	31 1/4"	19 1/2"	82"	8 1/2"	10			\$ 5,970	
	DM-8220-A-30-WH	Double Face Adder	30 1/4"	19 1/2"	82"	8 1/2"	10			\$ 5,303	
	DM-8224-S-30-WH	Double Face Starter	31 1/4"	23 1/2"	82"	10 1/2"	10			\$ 6,048	
	DM-8224-A-30-WH	Double Face Adder	30 1/4"	23 1/2"	82"	10 1/2"	10			\$ 5,387	
	DM-8220-S-36-WH	Double Face Starter	37 1/4"	19 1/2"	82"	8 1/2"	10	224 Lbs.	12 Cu Ft	\$ 5,697	
	DM-8220-A-36-WH	Double Face Adder	36 1/4"	19 1/2"	82"	8 1/2"	10	184 Lbs.	11 Cu Ft	\$ 5,029	
	DM-8224-S-36-WH	Double Face Starter	37 1/4"	23 1/2"	82"	10 1/2"	10	256 Lbs.	14 Cu Ft	\$ 5,775	
	DM-8224-A-36-WH	Double Face Adder	36 1/4"	23 1/2"	82"	10 1/2"	10	207 Lbs.	12 Cu Ft	\$ 5,115	
 Model Shown DM-9624-S-36-WH	DM-9620-S-24-WH	Double Face Starter	25 1/4"	19 1/2"	96"	8 1/2"	12			\$ 6,173	
	DM-9620-A-24-WH	Double Face Adder	24 1/4"	19 1/2"	96"	8 1/2"	12			\$ 5,511	
	DM-9624-S-24-WH	Double Face Starter	25 1/4"	23 1/2"	96"	10 1/2"	12			\$ 6,273	
	DM-9624-A-24-WH	Double Face Adder	24 1/4"	23 1/2"	96"	10 1/2"	12			\$ 5,621	
 Model Shown DM-9624-A-36-WH	DM-9620-S-30-WH	Double Face Starter	31 1/4"	19 1/2"	96"	8 1/2"	12			\$ 6,173	
	DM-9620-A-30-WH	Double Face Adder	30 1/4"	19 1/2"	96"	8 1/2"	12			\$ 5,511	
	DM-9624-S-30-WH	Double Face Starter	31 1/4"	23 1/2"	96"	10 1/2"	12			\$ 6,273	
	DM-9624-A-30-WH	Double Face Adder	30 1/4"	23 1/2"	96"	10 1/2"	12			\$ 5,621	
	DM-9620-S-36-WH	Double Face Starter	37 1/4"	19 1/2"	96"	8 1/2"	12	276 Lbs.	13 Cu Ft	\$ 5,909	
	DM-9620-A-36-WH	Double Face Adder	36 1/4"	19 1/2"	96"	8 1/2"	12	220 Lbs.	12 Cu Ft	\$ 5,239	
	DM-9624-S-36-WH	Double Face Starter	37 1/4"	23 1/2"	96"	10 1/2"	12	315 Lbs.	15 Cu Ft	\$ 5,994	
	DM-9624-A-36-WH	Double Face Adder	36 1/4"	23 1/2"	96"	10 1/2"	12	247 Lbs.	13 Cu Ft	\$ 5,334	

MODEL NUMBER	PRODUCT	WIDTH	DEPTH	HEIGHT	SHELF DEPTH	# OF SHELVES	# OF OPENINGS	WEIGHT	VOLUME	LIST PRICE	DESCRIPTION
 Model Shown DM-3612-S-36-SG	DM-3610-S-24-SG	Single Face Starter	25 1/4"	10 1/8"	36"	8 1/2"	1			\$ 2,363	End, Mid, Top and Base Panels to be constructed from 1" thick 11-ply solid core, veneered 2 sides. Vertical, top and bottom edges banded with 1/4" external hardwood edging, edges to be eased. Front Edge: 3/4" thick x 2 1/2" high fascia - tongue and grooved to top.
	DM-3610-A-24-SG	Single Face Adder	24 1/4"	10 1/8"	36"	8 1/2"	1			\$ 2,014	
	DM-3612-S-24-SG	Single Face Starter	25 1/4"	12 1/8"	36"	10 1/2"	1			\$ 2,417	
	DM-3612-A-24-SG	Single Face Adder	24 1/4"	12 1/8"	36"	10 1/2"	1			\$ 2,045	
 Model Shown DM-3612-S-30-SG	DM-3610-S-30-SG	Single Face Starter	31 1/4"	10 1/8"	36"	8 1/2"	1			\$ 2,363	
	DM-3610-A-30-SG	Single Face Adder	30 1/4"	10 1/8"	36"	8 1/2"	1			\$ 2,014	
	DM-3612-S-30-SG	Single Face Starter	31 1/4"	12 1/8"	36"	10 1/2"	1			\$ 2,417	
	DM-3612-A-30-SG	Single Face Adder	30 1/4"	12 1/8"	36"	10 1/2"	1			\$ 2,045	
 Model Shown DM-3612-A-36-SG	DM-3610-S-36-SG	Single Face Starter	37 1/4"	10 1/8"	36"	8 1/2"	1			\$ 2,200	
	DM-3610-A-36-SG	Single Face Adder	36 1/4"	10 1/8"	36"	8 1/2"	1			\$ 1,858	
	DM-3612-S-36-SG	Single Face Starter	37 1/4"	12 1/8"	36"	10 1/2"	1			\$ 2,246	
	DM-3612-A-36-SG	Single Face Adder	36 1/4"	12 1/8"	36"	10 1/2"	1			\$ 1,873	
 Model Shown DM-4212-S-36-SG	DM-4210-S-24-SG	Single Face Starter	25 1/4"	10 1/8"	42"	8 1/2"	2			\$ 2,463	
	DM-4210-A-24-SG	Single Face Adder	24 1/4"	10 1/8"	42"	8 1/2"	2			\$ 2,115	
	DM-4212-S-24-SG	Single Face Starter	25 1/4"	12 1/8"	42"	10 1/2"	2			\$ 2,519	
	DM-4212-A-24-SG	Single Face Adder	24 1/4"	12 1/8"	42"	10 1/2"	2			\$ 2,146	
 Model Shown DM-4212-S-30-SG	DM-4210-S-30-SG	Single Face Starter	31 1/4"	10 1/8"	42"	8 1/2"	2			\$ 2,463	
	DM-4210-A-30-SG	Single Face Adder	30 1/4"	10 1/8"	42"	8 1/2"	2			\$ 2,115	
	DM-4212-S-30-SG	Single Face Starter	31 1/4"	12 1/8"	42"	10 1/2"	2			\$ 2,519	
	DM-4212-A-30-SG	Single Face Adder	30 1/4"	12 1/8"	42"	10 1/2"	2			\$ 2,146	
 Model Shown DM-4212-A-36-SG	DM-4210-S-36-SG	Single Face Starter	37 1/4"	10 1/8"	42"	8 1/2"	2			\$ 2,293	
	DM-4210-A-36-SG	Single Face Adder	36 1/4"	10 1/8"	42"	8 1/2"	2			\$ 1,945	
	DM-4212-S-36-SG	Single Face Starter	37 1/4"	12 1/8"	42"	10 1/2"	2			\$ 2,339	
	DM-4212-A-36-SG	Single Face Adder	36 1/4"	12 1/8"	42"	10 1/2"	2			\$ 1,976	
	DM-4810-S-24-SG	Single Face Starter	25 1/4"	10 1/8"	48"	8 1/2"	2			\$ 2,535	
	DM-4810-A-24-SG	Single Face Adder	24 1/4"	10 1/8"	48"	8 1/2"	2			\$ 2,169	
	DM-4812-S-24-SG	Single Face Starter	25 1/4"	12 1/8"	48"	10 1/2"	2			\$ 2,551	
	DM-4812-A-24-SG	Single Face Adder	24 1/4"	12 1/8"	48"	10 1/2"	2			\$ 2,169	
	DM-4810-S-30-SG	Single Face Starter	31 1/4"	10 1/8"	48"	8 1/2"	2			\$ 2,566	
	DM-4810-A-30-SG	Single Face Adder	30 1/4"	10 1/8"	48"	8 1/2"	2			\$ 2,169	
	DM-4812-S-30-SG	Single Face Starter	31 1/4"	12 1/8"	48"	10 1/2"	2			\$ 2,551	
	DM-4812-A-30-SG	Single Face Adder	30 1/4"	12 1/8"	48"	10 1/2"	2			\$ 2,169	
	DM-4810-S-36-SG	Single Face Starter	37 1/4"	10 1/8"	48"	8 1/2"	2			\$ 2,363	
	DM-4810-A-36-SG	Single Face Adder	36 1/4"	10 1/8"	48"	8 1/2"	2			\$ 1,998	
	DM-4812-S-36-SG	Single Face Starter	37 1/4"	12 1/8"	48"	10 1/2"	2			\$ 2,379	
	DM-4812-A-36-SG	Single Face Adder	36 1/4"	12 1/8"	48"	10 1/2"	2			\$ 1,998	

	MODEL NUMBER	PRODUCT	WIDTH	DEPTH	HEIGHT	SHELF DEPTH	# OF SHELVES	# OF OPENINGS	WEIGHT	VOLUME	LIST PRICE	DESCRIPTION
 Model Shown DM-6012-S-36-SG	DM-6010-S-24-SG	Single Face Starter	25 1/4"	10 1/8"	60"	8 1/2"	3	4			\$ 3,227	End, Mid, Top and Base Panels to be constructed from 1" thick 11-ply solid core, veneered 2 sides. Vertical, top and bottom edges banded with 1/4" external hardwood edging, edges to be eased. Front Edge: 3/4" thick x 2 1/2" high fascia - tongue and grooved to top.
	DM-6010-A-24-SG	Single Face Adder	24 1/4"	10 1/8"	60"	8 1/2"	3	4			\$ 2,876	
	DM-6012-S-24-SG	Single Face Starter	25 1/4"	12 1/8"	60"	10 1/2"	3	4			\$ 3,273	
	DM-6012-A-24-SG	Single Face Adder	24 1/4"	12 1/8"	60"	10 1/2"	3	4			\$ 2,907	
 Model Shown DM-6012-A-36-SG	DM-6010-S-30-SG	Single Face Starter	31 1/4"	10 1/8"	60"	8 1/2"	3	4			\$ 3,227	
	DM-6010-A-30-SG	Single Face Adder	30 1/4"	10 1/8"	60"	8 1/2"	3	4			\$ 2,876	
	DM-6012-S-30-SG	Single Face Starter	31 1/4"	12 1/8"	60"	10 1/2"	3	4			\$ 3,273	
	DM-6012-A-30-SG	Single Face Adder	30 1/4"	12 1/8"	60"	10 1/2"	3	4			\$ 2,907	
 Model Shown DM-6012-A-36-SG	DM-6010-S-36-SG	Single Face Starter	37 1/4"	10 1/8"	60"	8 1/2"	3	4	100 Lbs.	6 Cu Ft	\$ 3,023	
	DM-6010-A-36-SG	Single Face Adder	36 1/4"	10 1/8"	60"	8 1/2"	3	4	86.3 Lbs.	6 Cu Ft	\$ 2,705	
	DM-6012-S-36-SG	Single Face Starter	37 1/4"	12 1/8"	60"	10 1/2"	3	4	116 Lbs.	8 Cu Ft	\$ 3,102	
	DM-6012-A-36-SG	Single Face Adder	36 1/4"	12 1/8"	60"	10 1/2"	3	4	95.5 Lbs.	7 Cu Ft	\$ 2,736	
 Model Shown DM-7212-S-36-SG	DM-7210-S-24-SG	Single Face Starter	25 1/4"	10 1/8"	72"	8 1/2"	4	5			\$ 3,327	
	DM-7210-A-24-SG	Single Face Adder	24 1/4"	10 1/8"	72"	8 1/2"	4	5			\$ 2,961	
	DM-7212-S-24-SG	Single Face Starter	25 1/4"	12 1/8"	72"	10 1/2"	4	5			\$ 3,382	
	DM-7212-A-24-SG	Single Face Adder	24 1/4"	12 1/8"	72"	10 1/2"	4	5			\$ 3,023	
 Model Shown DM-7212-S-36-SG	DM-7210-S-30-SG	Single Face Starter	31 1/4"	10 1/8"	72"	8 1/2"	4	5			\$ 3,327	
	DM-7210-A-30-SG	Single Face Adder	30 1/4"	10 1/8"	72"	8 1/2"	4	5			\$ 2,961	
	DM-7212-S-30-SG	Single Face Starter	31 1/4"	12 1/8"	72"	10 1/2"	4	5			\$ 3,382	
	DM-7212-A-30-SG	Single Face Adder	30 1/4"	12 1/8"	72"	10 1/2"	4	5			\$ 3,023	
 Model Shown DM-7212-A-36-SG	DM-7210-S-36-SG	Single Face Starter	37 1/4"	10 1/8"	72"	8 1/2"	4	5	115 Lbs.	7 Cu Ft	\$ 3,148	
	DM-7210-A-36-SG	Single Face Adder	36 1/4"	10 1/8"	72"	8 1/2"	4	5	96.6 Lbs.	7 Cu Ft	\$ 2,791	
	DM-7212-S-36-SG	Single Face Starter	37 1/4"	12 1/8"	72"	10 1/2"	4	5	131 Lbs.	8 Cu Ft	\$ 3,210	
	DM-7212-A-36-SG	Single Face Adder	36 1/4"	12 1/8"	72"	10 1/2"	4	5	109 Lbs.	8 Cu Ft	\$ 2,846	

MODEL NUMBER	PRODUCT	WIDTH	DEPTH	HEIGHT	SHELF DEPTH	# OF SHELVES	# OF OPENINGS	WEIGHT	VOLUME	LIST PRICE	DESCRIPTION
DM-8210-S-24-SG	Single Face Starter	25 1/4"	10 1/8"	82"	8 1/2"	5	6			\$ 3,428	End, Mid, Top and Base Panels to be constructed from 1" thick 11-ply solid core, veneered 2 sides. Vertical, top and bottom edges banded with 1/4" external hardwood edging, edges to be eased. Front Edge: 3/4" thick x 2 1/2" high fascia - tongue and grooved to top.
DM-8210-A-24-SG	Single Face Adder	24 1/4"	10 1/8"	82"	8 1/2"	5	6			\$ 3,070	
DM-8212-S-24-SG	Single Face Starter	25 1/4"	12 1/8"	82"	10 1/2"	5	6			\$ 3,490	
DM-8212-A-24-SG	Single Face Adder	24 1/4"	12 1/8"	82"	10 1/2"	5	6			\$ 3,116	
DM-8210-S-30-SG	Single Face Starter	31 1/4"	10 1/8"	82"	8 1/2"	5	6			\$ 3,428	
DM-8210-A-30-SG	Single Face Adder	30 1/4"	10 1/8"	82"	8 1/2"	5	6			\$ 3,070	
DM-8212-S-30-SG	Single Face Starter	31 1/4"	12 1/8"	82"	10 1/2"	5	6			\$ 3,490	
DM-8212-A-30-SG	Single Face Adder	30 1/4"	12 1/8"	82"	10 1/2"	5	6			\$ 3,116	
DM-8210-S-36-SG	Single Face Starter	37 1/4"	10 1/8"	82"	8 1/2"	5	6	129 Lbs.	8 Cu Ft	\$ 3,258	
DM-8210-A-36-SG	Single Face Adder	36 1/4"	10 1/8"	82"	8 1/2"	5	6	107 Lbs.	7 Cu Ft	\$ 2,899	
DM-8212-S-36-SG	Single Face Starter	37 1/4"	12 1/8"	82"	10 1/2"	5	6	145 Lbs.	9 Cu Ft	\$ 3,319	
DM-8212-A-36-SG	Single Face Adder	36 1/4"	12 1/8"	82"	10 1/2"	5	6	122 Lbs.	8 Cu Ft	\$ 2,946	
DM-9610-S-24-SG	Single Face Starter	25 1/4"	10 1/8"	96"	8 1/2"	6	7			\$ 3,514	
DM-9610-A-24-SG	Single Face Adder	24 1/4"	10 1/8"	96"	8 1/2"	6	7			\$ 3,164	
DM-9612-S-24-SG	Single Face Starter	25 1/4"	12 1/8"	96"	10 1/2"	6	7			\$ 3,599	
DM-9612-A-24-SG	Single Face Adder	24 1/4"	12 1/8"	96"	10 1/2"	6	7			\$ 3,227	
DM-9610-S-30-SG	Single Face Starter	31 1/4"	10 1/8"	96"	8 1/2"	6	7			\$ 3,514	
DM-9610-A-30-SG	Single Face Adder	30 1/4"	10 1/8"	96"	8 1/2"	6	7			\$ 3,164	
DM-9612-S-30-SG	Single Face Starter	31 1/4"	12 1/8"	96"	10 1/2"	6	7			\$ 3,599	
DM-9612-A-30-SG	Single Face Adder	30 1/4"	12 1/8"	96"	10 1/2"	6	7			\$ 3,227	
DM-9610-S-36-SG	Single Face Starter	37 1/4"	10 1/8"	96"	8 1/2"	6	7	156 Lbs.	9 Cu Ft	\$ 3,343	
DM-9610-A-36-SG	Single Face Adder	36 1/4"	10 1/8"	96"	8 1/2"	6	7	128 Lbs.	8 Cu Ft	\$ 2,992	
DM-9612-S-36-SG	Single Face Starter	37 1/4"	12 1/8"	96"	10 1/2"	6	7	177 Lbs.	10 Cu Ft	\$ 3,428	
DM-9612-A-36-SG	Single Face Adder	36 1/4"	12 1/8"	96"	10 1/2"	6	7	145 Lbs.	9 Cu Ft	\$ 3,056	



Model Shown  
DM-8212-S-36-SG







Model Shown  
DM-8212-A-36-SG





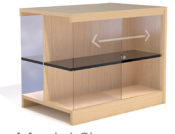

Model Shown  
DM-9612-S-36-SG











Model Shown  
DM-9612-A-36-SG





	MODEL NUMBER	PRODUCT	WIDTH	DEPTH	HEIGHT	SHELF DEPTH	# OF SHELVES	# OF OPENINGS	WEIGHT	VOLUME	LIST PRICE	DESCRIPTION
 <p>Model Shown DM-3624-S-36-SG</p>	DM-3620-S-24-SG	Double Face Starter	25 1/4"	19 1/2"	36"	8 1/2"	2	4			\$ 4,649	End, Mid, Top and Base Panels to be constructed from 1" thick 11-ply solid core, veneered 2 sides. Vertical, top and bottom edges banded with 1/4" external hardwood edging, edges to be eased. Front Edge: 3/4" thick x 2 1/2" high fascia - tongue and grooved to top.
	DM-3620-A-24-SG	Double Face Adder	24 1/4"	19 1/2"	36"	8 1/2"	2	4			\$ 4,042	
	DM-3624-S-24-SG	Double Face Starter	25 1/4"	23 1/2"	36"	10 1/2"	2	4			\$ 4,694	
	DM-3624-A-24-SG	Double Face Adder	24 1/4"	23 1/2"	36"	10 1/2"	2	4			\$ 4,058	
 <p>Model Shown DM-3624-S-30-SG</p>	DM-3620-S-30-SG	Double Face Starter	31 1/4"	19 1/2"	36"	8 1/2"	2	4			\$ 4,649	
	DM-3620-A-30-SG	Double Face Adder	30 1/4"	19 1/2"	36"	8 1/2"	2	4			\$ 4,042	
	DM-3624-S-30-SG	Double Face Starter	31 1/4"	23 1/2"	36"	10 1/2"	2	4			\$ 4,694	
	DM-3624-A-30-SG	Double Face Adder	30 1/4"	23 1/2"	36"	10 1/2"	2	4			\$ 4,058	
 <p>Model Shown DM-3624-A-36-SG</p>	DM-3620-S-36-SG	Double Face Starter	37 1/4"	19 1/2"	36"	8 1/2"	2	4	88.6 Lbs.	7 Cu Ft	\$ 4,385	
	DM-3620-A-36-SG	Double Face Adder	36 1/4"	19 1/2"	36"	8 1/2"	2	4	73.6 Lbs.	6 Cu Ft	\$ 3,778	
	DM-3624-S-36-SG	Double Face Starter	37 1/4"	23 1/2"	36"	10 1/2"	2	4	110 Lbs.	10 Cu Ft	\$ 4,439	
	DM-3624-A-36-SG	Double Face Adder	36 1/4"	23 1/2"	36"	10 1/2"	2	4	88.6 Lbs.	9 Cu Ft	\$ 3,801	
 <p>Model Shown DM-4224-S-36-SG</p>	DM-4220-S-24-SG	Double Face Starter	25 1/4"	19 1/2"	42"	8 1/2"	4	6			\$ 4,851	
	DM-4220-A-24-SG	Double Face Adder	24 1/4"	19 1/2"	42"	8 1/2"	4	6			\$ 4,245	
	DM-4224-S-24-SG	Double Face Starter	25 1/4"	23 1/2"	42"	10 1/2"	4	6			\$ 4,905	
	DM-4224-A-24-SG	Double Face Adder	24 1/4"	23 1/2"	42"	10 1/2"	4	6			\$ 4,276	
 <p>Model Shown DM-4224-S-30-SG</p>	DM-4220-S-30-SG	Double Face Starter	31 1/4"	19 1/2"	42"	8 1/2"	4	6			\$ 4,851	
	DM-4220-A-30-SG	Double Face Adder	30 1/4"	19 1/2"	42"	8 1/2"	4	6			\$ 4,245	
	DM-4224-S-30-SG	Double Face Starter	31 1/4"	23 1/2"	42"	10 1/2"	4	6			\$ 4,905	
	DM-4224-A-30-SG	Double Face Adder	30 1/4"	23 1/2"	42"	10 1/2"	4	6			\$ 4,276	
 <p>Model Shown DM-4224-A-36-SG</p>	DM-4220-S-36-SG	Double Face Starter	37 1/4"	19 1/2"	42"	8 1/2"	4	6	94 Lbs.	7 Cu Ft	\$ 4,594	
	DM-4220-A-36-SG	Double Face Adder	36 1/4"	19 1/2"	42"	8 1/2"	4	6	78 Lbs.	7 Cu Ft	\$ 3,980	
	DM-4224-S-36-SG	Double Face Starter	37 1/4"	23 1/2"	42"	10 1/2"	4	6	115 Lbs.	10 Cu Ft	\$ 4,649	
	DM-4224-A-36-SG	Double Face Adder	36 1/4"	23 1/2"	42"	10 1/2"	4	6	113 Lbs.	10 Cu Ft	\$ 4,004	
	DM-4820-S-24-SG	Double Face Starter	25 1/4"	19 1/2"	48"	8 1/2"	4	6			\$ 5,092	
	DM-4820-A-24-SG	Double Face Adder	24 1/4"	19 1/2"	48"	8 1/2"	4	6			\$ 4,453	
	DM-4824-S-24-SG	Double Face Starter	25 1/4"	23 1/2"	48"	10 1/2"	4	6			\$ 5,146	
	DM-4824-A-24-SG	Double Face Adder	24 1/4"	23 1/2"	48"	10 1/2"	4	6			\$ 4,485	
	DM-4820-S-30-SG	Double Face Starter	31 1/4"	19 1/2"	48"	8 1/2"	4	6			\$ 5,092	
	DM-4820-A-30-SG	Double Face Adder	30 1/4"	19 1/2"	48"	8 1/2"	4	6			\$ 4,453	
	DM-4824-S-30-SG	Double Face Starter	31 1/4"	23 1/2"	48"	10 1/2"	4	6			\$ 5,146	
	DM-4824-A-30-SG	Double Face Adder	30 1/4"	23 1/2"	48"	10 1/2"	4	6			\$ 4,485	
	DM-4820-S-36-SG	Double Face Starter	37 1/4"	19 1/2"	48"	8 1/2"	4	6	132 Lbs.	9 Cu Ft	\$ 4,812	
	DM-4820-A-36-SG	Double Face Adder	36 1/4"	19 1/2"	48"	8 1/2"	4	6	109 Lbs.	8 Cu Ft	\$ 4,175	
	DM-4824-S-36-SG	Double Face Starter	37 1/4"	23 1/2"	48"	10 1/2"	4	6	155 Lbs.	11 Cu Ft	\$ 4,882	
	DM-4824-A-36-SG	Double Face Adder	36 1/4"	23 1/2"	48"	10 1/2"	4	6	127 Lbs.	10 Cu Ft	\$ 4,204	





	MODEL NUMBER	PRODUCT	WIDTH	DEPTH	HEIGHT	SHELF DEPTH	# OF SHELVES	# OF OPENINGS	WEIGHT	VOLUME	LIST PRICE	DESCRIPTION
 <p>Model Shown DM-6024-S-36-SG</p>	DM-6020-S-24-SG	Double Face Starter	25 1/4"	19 1/2"	60"	8 1/2"	6	8			\$ 6,468	End, Mid, Top and Base Panels to be constructed from 1" thick 11-ply solid core, veneered 2 sides. Vertical, top and bottom edges banded with 1/4" external hardwood edging, edges to be eased. Front Edge: 3/4" thick x 2 1/2" high fascia - tongue and grooved to top.
	DM-6020-A-24-SG	Double Face Adder	24 1/4"	19 1/2"	60"	8 1/2"	6	8			\$ 5,839	
	DM-6024-S-24-SG	Double Face Starter	25 1/4"	23 1/2"	60"	10 1/2"	6	8			\$ 6,515	
	DM-6024-A-24-SG	Double Face Adder	24 1/4"	23 1/2"	60"	10 1/2"	6	8			\$ 5,893	
	DM-6020-S-30-SG	Double Face Starter	31 1/4"	19 1/2"	60"	8 1/2"	6	8			\$ 6,468	
	DM-6020-A-30-SG	Double Face Adder	30 1/4"	19 1/2"	60"	8 1/2"	6	8			\$ 5,839	
	DM-6024-S-30-SG	Double Face Starter	31 1/4"	23 1/2"	60"	10 1/2"	6	8			\$ 6,515	
	DM-6024-A-30-SG	Double Face Adder	30 1/4"	23 1/2"	60"	10 1/2"	6	8			\$ 5,893	
 <p>Model Shown DM-6024-A-36-SG</p>	DM-6020-S-36-SG	Double Face Starter	37 1/4"	19 1/2"	60"	8 1/2"	6	8	176 Lbs.	11 Cu Ft	\$ 6,211	
	DM-6020-A-36-SG	Double Face Adder	36 1/4"	19 1/2"	60"	8 1/2"	6	8	145 Lbs.	10 Cu Ft	\$ 5,573	
	DM-6024-S-36-SG	Double Face Starter	37 1/4"	23 1/2"	60"	10 1/2"	6	8	200 Lbs.	12 Cu Ft	\$ 6,265	
	DM-6024-A-36-SG	Double Face Adder	36 1/4"	23 1/2"	60"	10 1/2"	6	8	164 Lbs.	11 Cu Ft	\$ 5,635	
 <p>Model Shown DM-7224-S-36-SG</p>	DM-7220-S-24-SG	Double Face Starter	25 1/4"	19 1/2"	72"	8 1/2"	8	10			\$ 6,678	
	DM-7220-A-24-SG	Double Face Adder	24 1/4"	19 1/2"	72"	8 1/2"	8	10			\$ 6,040	
	DM-7224-S-24-SG	Double Face Starter	25 1/4"	23 1/2"	72"	10 1/2"	8	10			\$ 6,585	
	DM-7224-A-24-SG	Double Face Adder	24 1/4"	23 1/2"	72"	10 1/2"	8	10			\$ 6,094	
	DM-7220-S-30-SG	Double Face Starter	31 1/4"	19 1/2"	72"	8 1/2"	8	10			\$ 6,678	
	DM-7220-A-30-SG	Double Face Adder	30 1/4"	19 1/2"	72"	8 1/2"	8	10			\$ 6,040	
	DM-7224-S-30-SG	Double Face Starter	31 1/4"	23 1/2"	72"	10 1/2"	8	10			\$ 6,585	
	DM-7224-A-30-SG	Double Face Adder	30 1/4"	23 1/2"	72"	10 1/2"	8	10			\$ 6,094	
 <p>Model Shown DM-7224-A-36-SG</p>	DM-7220-S-36-SG	Double Face Starter	37 1/4"	19 1/2"	72"	8 1/2"	8	10	200 Lbs.	12 Cu Ft	\$ 6,414	
	DM-7220-A-36-SG	Double Face Adder	36 1/4"	19 1/2"	72"	8 1/2"	8	10	164 Lbs.	11 Cu Ft	\$ 5,775	
	DM-7224-S-36-SG	Double Face Starter	37 1/4"	23 1/2"	72"	10 1/2"	8	10	229 Lbs.	13 Cu Ft	\$ 6,474	
	DM-7224-A-36-SG	Double Face Adder	36 1/4"	23 1/2"	72"	10 1/2"	8	10	186 Lbs.	12 Cu Ft	\$ 5,839	



MODEL NUMBER	PRODUCT	WIDTH	DEPTH	HEIGHT	SHELF DEPTH	# OF SHELVES	# OF OPENINGS	WEIGHT	VOLUME	LIST PRICE	DESCRIPTION
 Model Shown DM-8224-S-36-SG	DM-8220-S-24-SG	Double Face Starter	25 1/4"	19 1/2"	82"	8 1/2"	10			\$ 6,864	End, Mid, Top and Base Panels to be constructed from 1" thick 11-ply solid core, veneered 2 sides. Vertical, top and bottom edges banded with 1/4" external hardwood edging, edges to be eased. Front Edge: 3/4" thick x 2 1/2" high fascia - tongue and grooved to top.
	DM-8220-A-24-SG	Double Face Adder	24 1/4"	19 1/2"	82"	8 1/2"	10			\$ 6,234	
	DM-8224-S-24-SG	Double Face Starter	25 1/4"	23 1/2"	82"	10 1/2"	10			\$ 6,933	
	DM-8224-A-24-SG	Double Face Adder	24 1/4"	23 1/2"	82"	10 1/2"	10			\$ 6,311	
 Model Shown DM-8224-A-36-SG	DM-8220-S-30-SG	Double Face Starter	31 1/4"	19 1/2"	82"	8 1/2"	10			\$ 6,864	
	DM-8220-A-30-SG	Double Face Adder	30 1/4"	19 1/2"	82"	8 1/2"	10			\$ 6,234	
	DM-8224-S-30-SG	Double Face Starter	31 1/4"	23 1/2"	82"	10 1/2"	10			\$ 6,933	
	DM-8224-A-30-SG	Double Face Adder	30 1/4"	23 1/2"	82"	10 1/2"	10			\$ 6,311	
	DM-8220-S-36-SG	Double Face Starter	37 1/4"	19 1/2"	82"	8 1/2"	10			\$ 6,599	
	DM-8220-A-36-SG	Double Face Adder	36 1/4"	19 1/2"	82"	8 1/2"	10	224 Lbs.	12 Cu Ft	\$ 5,970	
	DM-8224-S-36-SG	Double Face Starter	37 1/4"	23 1/2"	82"	10 1/2"	10	256 Lbs.	14 Cu Ft	\$ 6,662	
	DM-8224-A-36-SG	Double Face Adder	36 1/4"	23 1/2"	82"	10 1/2"	10	207 Lbs.	12 Cu Ft	\$ 6,056	
 Model Shown DM-9624-S-36-SG	DM-9620-S-24-SG	Double Face Starter	25 1/4"	19 1/2"	96"	8 1/2"	12			\$ 7,058	
	DM-9620-A-24-SG	Double Face Adder	24 1/4"	19 1/2"	96"	8 1/2"	12			\$ 6,428	
	DM-9624-S-24-SG	Double Face Starter	25 1/4"	23 1/2"	96"	10 1/2"	12			\$ 7,159	
	DM-9624-A-24-SG	Double Face Adder	24 1/4"	23 1/2"	96"	10 1/2"	12			\$ 6,515	
 Model Shown DM-9624-A-36-SG	DM-9620-S-30-SG	Double Face Starter	31 1/4"	19 1/2"	96"	8 1/2"	12			\$ 7,058	
	DM-9620-A-30-SG	Double Face Adder	30 1/4"	19 1/2"	96"	8 1/2"	12			\$ 6,428	
	DM-9624-S-30-SG	Double Face Starter	31 1/4"	23 1/2"	96"	10 1/2"	12			\$ 7,159	
	DM-9624-A-30-SG	Double Face Adder	30 1/4"	23 1/2"	96"	10 1/2"	12			\$ 6,515	
	DM-9620-S-36-SG	Double Face Starter	37 1/4"	19 1/2"	96"	8 1/2"	12	276 Lbs.	13 Cu Ft	\$ 6,802	
	DM-9620-A-36-SG	Double Face Adder	36 1/4"	19 1/2"	96"	8 1/2"	12	220 Lbs.	12 Cu Ft	\$ 6,164	
	DM-9624-S-36-SG	Double Face Starter	37 1/4"	23 1/2"	96"	10 1/2"	12	315 Lbs.	15 Cu Ft	\$ 6,887	
	DM-9624-A-36-SG	Double Face Adder	36 1/4"	23 1/2"	96"	10 1/2"	12	247 Lbs.	13 Cu Ft	\$ 6,257	

	MODEL NUMBER	PRODUCT	WIDTH	DEPTH	HEIGHT	SHELF DEPTH	# OF SHELVES	# OF OPENINGS	WEIGHT	VOLUME	LIST PRICE	DESCRIPTION
 Model Shown DM-3612-S-LB-36  Model Shown DM-3612-A-LB-36	DM-3610-S-LB-24	Single Face Starter	25 <sup>1</sup> / <sub>4</sub> "	10 <sup>1</sup> / <sub>8</sub> "	36"	9 <sup>1</sup> / <sub>2</sub> "	1	2			\$ 1,290	End, Mid, Top and Base Panels to be constructed from 1" thick 11-ply solid core, veneered 2 sides. Vertical, top and bottom edges banded with 1/4" external hardwood edging, edges to be eased. Front Edge: 3/4" thick x 2 1/2" high fascia - tongue and grooved to top.
	DM-3610-A-LB-24	Single Face Adder	24 <sup>1</sup> / <sub>4</sub> "	10 <sup>1</sup> / <sub>8</sub> "	36"	9 <sup>1</sup> / <sub>2</sub> "	1	2			\$ 918	
	DM-3612-S-LB-24	Single Face Starter	25 <sup>1</sup> / <sub>4</sub> "	12 <sup>1</sup> / <sub>8</sub> "	36"	11 <sup>1</sup> / <sub>2</sub> "	1	2			\$ 1,354	
	DM-3612-A-LB-24	Single Face Adder	24 <sup>1</sup> / <sub>4</sub> "	12 <sup>1</sup> / <sub>8</sub> "	36"	11 <sup>1</sup> / <sub>2</sub> "	1	2			\$ 949	
	DM-3610-S-LB-30	Single Face Starter	31 <sup>1</sup> / <sub>4</sub> "	10 <sup>1</sup> / <sub>8</sub> "	36"	9 <sup>1</sup> / <sub>2</sub> "	1	2			\$ 1,290	
	DM-3610-A-LB-30	Single Face Adder	30 <sup>1</sup> / <sub>4</sub> "	10 <sup>1</sup> / <sub>8</sub> "	36"	9 <sup>1</sup> / <sub>2</sub> "	1	2			\$ 918	
	DM-3612-S-LB-30	Single Face Starter	31 <sup>1</sup> / <sub>4</sub> "	12 <sup>1</sup> / <sub>8</sub> "	36"	11 <sup>1</sup> / <sub>2</sub> "	1	2			\$ 1,354	
	DM-3612-A-LB-30	Single Face Adder	30 <sup>1</sup> / <sub>4</sub> "	12 <sup>1</sup> / <sub>8</sub> "	36"	11 <sup>1</sup> / <sub>2</sub> "	1	2			\$ 949	
DM-3610-S-LB-36	Single Face Starter	37 <sup>1</sup> / <sub>4</sub> "	10 <sup>1</sup> / <sub>8</sub> "	36"	9 <sup>1</sup> / <sub>2</sub> "	1	2	50.6 Lbs.	4 Cu Ft	\$ 1,105		
DM-3610-A-LB-36	Single Face Adder	36 <sup>1</sup> / <sub>4</sub> "	10 <sup>1</sup> / <sub>8</sub> "	36"	9 <sup>1</sup> / <sub>2</sub> "	1	2	46 Lbs.	4 Cu Ft	\$ 722		
DM-3612-S-LB-36	Single Face Starter	37 <sup>1</sup> / <sub>4</sub> "	12 <sup>1</sup> / <sub>8</sub> "	36"	11 <sup>1</sup> / <sub>2</sub> "	1	2	50.6 Lbs.	5 Cu Ft	\$ 1,158		
DM-3612-A-LB-36	Single Face Adder	36 <sup>1</sup> / <sub>4</sub> "	12 <sup>1</sup> / <sub>8</sub> "	36"	11 <sup>1</sup> / <sub>2</sub> "	1	2	47.2 Lbs.	5 Cu Ft	\$ 762		
 Model Shown DM-4212-S-LB-36  Model Shown DM-4212-A-LB-36	DM-4210-S-LB-24	Single Face Starter	25 <sup>1</sup> / <sub>4</sub> "	10 <sup>1</sup> / <sub>8</sub> "	42"	9 <sup>1</sup> / <sub>2</sub> "	2	3			\$ 1,393	
	DM-4210-A-LB-24	Single Face Adder	24 <sup>1</sup> / <sub>4</sub> "	10 <sup>1</sup> / <sub>8</sub> "	42"	9 <sup>1</sup> / <sub>2</sub> "	2	3			\$ 1,019	
	DM-4212-S-LB-24	Single Face Starter	25 <sup>1</sup> / <sub>4</sub> "	12 <sup>1</sup> / <sub>8</sub> "	42"	11 <sup>1</sup> / <sub>2</sub> "	2	3			\$ 1,447	
	DM-4212-A-LB-24	Single Face Adder	24 <sup>1</sup> / <sub>4</sub> "	12 <sup>1</sup> / <sub>8</sub> "	42"	11 <sup>1</sup> / <sub>2</sub> "	2	3			\$ 1,058	
	DM-4210-S-LB-30	Single Face Starter	31 <sup>1</sup> / <sub>4</sub> "	10 <sup>1</sup> / <sub>8</sub> "	42"	9 <sup>1</sup> / <sub>2</sub> "	2	3			\$ 1,393	
	DM-4210-A-LB-30	Single Face Adder	30 <sup>1</sup> / <sub>4</sub> "	10 <sup>1</sup> / <sub>8</sub> "	42"	9 <sup>1</sup> / <sub>2</sub> "	2	3			\$ 1,019	
	DM-4212-S-LB-30	Single Face Starter	31 <sup>1</sup> / <sub>4</sub> "	12 <sup>1</sup> / <sub>8</sub> "	42"	11 <sup>1</sup> / <sub>2</sub> "	2	3			\$ 1,447	
	DM-4212-A-LB-30	Single Face Adder	30 <sup>1</sup> / <sub>4</sub> "	12 <sup>1</sup> / <sub>8</sub> "	42"	11 <sup>1</sup> / <sub>2</sub> "	2	3			\$ 1,058	
	DM-4210-S-LB-36	Single Face Starter	37 <sup>1</sup> / <sub>4</sub> "	10 <sup>1</sup> / <sub>8</sub> "	42"	9 <sup>1</sup> / <sub>2</sub> "	2	3	55 Lbs.	5 Cu Ft	\$ 1,205	
	DM-4210-A-LB-36	Single Face Adder	36 <sup>1</sup> / <sub>4</sub> "	10 <sup>1</sup> / <sub>8</sub> "	42"	9 <sup>1</sup> / <sub>2</sub> "	2	3	52 Lbs.	5 Cu Ft	\$ 785	
	DM-4212-S-LB-36	Single Face Starter	37 <sup>1</sup> / <sub>4</sub> "	12 <sup>1</sup> / <sub>8</sub> "	42"	11 <sup>1</sup> / <sub>2</sub> "	2	3	60 Lbs.	5 Cu Ft	\$ 1,259	
	DM-4212-A-LB-36	Single Face Adder	36 <sup>1</sup> / <sub>4</sub> "	12 <sup>1</sup> / <sub>8</sub> "	42"	11 <sup>1</sup> / <sub>2</sub> "	2	3	53 Lbs.	5 Cu Ft	\$ 864	
	DM-4810-S-LB-24	Single Face Starter	25 <sup>1</sup> / <sub>4</sub> "	10 <sup>1</sup> / <sub>8</sub> "	48"	9 <sup>1</sup> / <sub>2</sub> "	2	3			\$ 1,423	
	DM-4810-A-LB-24	Single Face Adder	24 <sup>1</sup> / <sub>4</sub> "	10 <sup>1</sup> / <sub>8</sub> "	48"	9 <sup>1</sup> / <sub>2</sub> "	2	3			\$ 1,019	
	DM-4812-S-LB-24	Single Face Starter	25 <sup>1</sup> / <sub>4</sub> "	12 <sup>1</sup> / <sub>8</sub> "	48"	11 <sup>1</sup> / <sub>2</sub> "	2	3			\$ 1,462	
	DM-4812-A-LB-24	Single Face Adder	24 <sup>1</sup> / <sub>4</sub> "	12 <sup>1</sup> / <sub>8</sub> "	48"	11 <sup>1</sup> / <sub>2</sub> "	2	3			\$ 1,058	
DM-4810-S-LB-30	Single Face Starter	31 <sup>1</sup> / <sub>4</sub> "	10 <sup>1</sup> / <sub>8</sub> "	48"	9 <sup>1</sup> / <sub>2</sub> "	2	3			\$ 1,423		
DM-4810-A-LB-30	Single Face Adder	30 <sup>1</sup> / <sub>4</sub> "	10 <sup>1</sup> / <sub>8</sub> "	48"	9 <sup>1</sup> / <sub>2</sub> "	2	3			\$ 1,019		
DM-4812-S-LB-30	Single Face Starter	31 <sup>1</sup> / <sub>4</sub> "	12 <sup>1</sup> / <sub>8</sub> "	48"	11 <sup>1</sup> / <sub>2</sub> "	2	3			\$ 1,462		
DM-4812-A-LB-30	Single Face Adder	30 <sup>1</sup> / <sub>4</sub> "	12 <sup>1</sup> / <sub>8</sub> "	48"	11 <sup>1</sup> / <sub>2</sub> "	2	3			\$ 1,058		
DM-4810-S-LB-36	Single Face Starter	37 <sup>1</sup> / <sub>4</sub> "	10 <sup>1</sup> / <sub>8</sub> "	48"	9 <sup>1</sup> / <sub>2</sub> "	2	3	74.8 Lbs.	5 Cu Ft	\$ 1,220		
DM-4810-A-LB-36	Single Face Adder	36 <sup>1</sup> / <sub>4</sub> "	10 <sup>1</sup> / <sub>8</sub> "	48"	9 <sup>1</sup> / <sub>2</sub> "	2	3	65.5 Lbs.	5 Cu Ft	\$ 831		
DM-4812-S-LB-36	Single Face Starter	37 <sup>1</sup> / <sub>4</sub> "	12 <sup>1</sup> / <sub>8</sub> "	48"	11 <sup>1</sup> / <sub>2</sub> "	2	3	82.8 Lbs.	6 Cu Ft	\$ 1,275		
DM-4812-A-LB-36	Single Face Adder	36 <sup>1</sup> / <sub>4</sub> "	12 <sup>1</sup> / <sub>8</sub> "	48"	11 <sup>1</sup> / <sub>2</sub> "	2	3	71.3 Lbs.	6 Cu Ft	\$ 864		

	MODEL NUMBER	PRODUCT	WIDTH	DEPTH	HEIGHT	SHELF DEPTH	# OF SHELVES	# OF OPENINGS	WEIGHT	VOLUME	LIST PRICE	DESCRIPTION
 <p>Model Shown DM-6012-S-LB-36</p>	DM-6010-S-LB-24	Single Face Starter	25 1/4"	10 1/8"	60"	9 1/2"	3	4			\$ 1,447	End, Mid, Top and Base Panels to be constructed from 1" thick 11-ply solid core, veneered 2 sides. Vertical, top and bottom edges banded with 1/4" external hardwood edging, edges to be eased. Front Edge: 3/4" thick x 2 1/2" high fascia - tongue and grooved to top.
	DM-6010-A-LB-24	Single Face Adder	24 1/4"	10 1/8"	60"	9 1/2"	3	4			\$ 1,065	
	DM-6012-S-LB-24	Single Face Starter	25 1/4"	12 1/8"	60"	11 1/2"	3	4			\$ 1,493	
	DM-6012-A-LB-24	Single Face Adder	24 1/4"	12 1/8"	60"	11 1/2"	3	4			\$ 1,105	
	DM-6010-S-LB-30	Single Face Starter	31 1/4"	10 1/8"	60"	9 1/2"	3	4			\$ 1,447	
	DM-6010-A-LB-30	Single Face Adder	30 1/4"	10 1/8"	60"	9 1/2"	3	4			\$ 1,065	
	DM-6012-S-LB-30	Single Face Starter	31 1/4"	12 1/8"	60"	11 1/2"	3	4			\$ 1,493	
	DM-6012-A-LB-30	Single Face Adder	30 1/4"	12 1/8"	60"	11 1/2"	3	4			\$ 1,105	
 <p>Model Shown DM-6012-A-LB-36</p>	DM-6010-S-LB-36	Single Face Starter	37 1/4"	10 1/8"	60"	9 1/2"	3	4	100 Lbs.	6 Cu Ft	\$ 1,251	
	DM-6010-A-LB-36	Single Face Adder	36 1/4"	10 1/8"	60"	9 1/2"	3	4	86.3 Lbs.	6 Cu Ft	\$ 871	
	DM-6012-S-LB-36	Single Face Starter	37 1/4"	12 1/8"	60"	11 1/2"	3	4	116 Lbs.	8 Cu Ft	\$ 1,298	
	DM-6012-A-LB-36	Single Face Adder	36 1/4"	12 1/8"	60"	11 1/2"	3	4	95.5 Lbs.	7 Cu Ft	\$ 910	
 <p>Model Shown DM-7212-S-LB-36</p>	DM-7210-S-LB-24	Single Face Starter	25 1/4"	10 1/8"	72"	9 1/2"	4	5			\$ 1,531	
	DM-7210-A-LB-24	Single Face Adder	24 1/4"	10 1/8"	72"	9 1/2"	4	5			\$ 1,151	
	DM-7212-S-LB-24	Single Face Starter	25 1/4"	12 1/8"	72"	11 1/2"	4	5			\$ 1,593	
	DM-7212-A-LB-24	Single Face Adder	24 1/4"	12 1/8"	72"	11 1/2"	4	5			\$ 1,205	
	DM-7210-S-LB-30	Single Face Starter	31 1/4"	10 1/8"	72"	9 1/2"	4	5			\$ 1,531	
	DM-7210-A-LB-30	Single Face Adder	30 1/4"	10 1/8"	72"	9 1/2"	4	5			\$ 1,151	
	DM-7212-S-LB-30	Single Face Starter	31 1/4"	12 1/8"	72"	11 1/2"	4	5			\$ 1,593	
	DM-7212-A-LB-30	Single Face Adder	30 1/4"	12 1/8"	72"	11 1/2"	4	5			\$ 1,205	
 <p>Model Shown DM-7212-A-LB-36</p>	DM-7210-S-LB-36	Single Face Starter	37 1/4"	10 1/8"	72"	9 1/2"	4	5	115 Lbs.	7 Cu Ft	\$ 1,336	
	DM-7210-A-LB-36	Single Face Adder	36 1/4"	10 1/8"	72"	9 1/2"	4	5	96.6 Lbs.	7 Cu Ft	\$ 957	
	DM-7212-S-LB-36	Single Face Starter	37 1/4"	12 1/8"	72"	11 1/2"	4	5	131 Lbs.	8 Cu Ft	\$ 1,406	
	DM-7212-A-LB-36	Single Face Adder	36 1/4"	12 1/8"	72"	11 1/2"	4	5	109 Lbs.	8 Cu Ft	\$ 1,019	

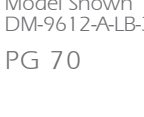



MODEL NUMBER	PRODUCT	WIDTH	DEPTH	HEIGHT	SHELF DEPTH	# OF SHELVES	# OF OPENINGS	WEIGHT	VOLUME	LIST PRICE	DESCRIPTION
	DM-8210-S-LB-24	Single Face Starter	25 1/4"	10 1/8"	82"	9 1/2"	5			\$ 1,624	End, Mid, Top and Base Panels to be constructed from 1" thick 11-ply solid core, veneered 2 sides. Vertical, top and bottom edges banded with 1/4" external hardwood edging, edges to be eased. Front Edge: 3/4" thick x 2 1/2" high fascia - tongue and grooved to top.
	DM-8210-A-LB-24	Single Face Adder	24 1/4"	10 1/8"	82"	9 1/2"	5			\$ 1,251	
	DM-8212-S-LB-24	Single Face Starter	25 1/4"	12 1/8"	82"	11 1/2"	5			\$ 1,695	
	DM-8212-A-LB-24	Single Face Adder	24 1/4"	12 1/8"	82"	11 1/2"	5			\$ 1,298	
	DM-8210-S-LB-30	Single Face Starter	31 1/4"	10 1/8"	82"	9 1/2"	5			\$ 1,624	
	DM-8210-A-LB-30	Single Face Adder	30 1/4"	10 1/8"	82"	9 1/2"	5			\$ 1,251	
	DM-8212-S-LB-30	Single Face Starter	31 1/4"	12 1/8"	82"	11 1/2"	5			\$ 1,695	
	DM-8212-A-LB-30	Single Face Adder	30 1/4"	12 1/8"	82"	11 1/2"	5			\$ 1,298	
	DM-8210-S-LB-36	Single Face Starter	37 1/4"	10 1/8"	82"	9 1/2"	5			\$ 1,439	
	DM-8210-A-LB-36	Single Face Adder	36 1/4"	10 1/8"	82"	9 1/2"	5	129 Lbs.	8 Cu Ft	\$ 1,058	
	DM-8212-S-LB-36	Single Face Starter	37 1/4"	12 1/8"	82"	11 1/2"	5	107 Lbs.	7 Cu Ft	\$ 1,500	
	DM-8212-A-LB-36	Single Face Adder	36 1/4"	12 1/8"	82"	11 1/2"	5	145 Lbs.	9 Cu Ft	\$ 1,112	
											
											
	DM-9610-S-LB-24	Single Face Starter	25 1/4"	10 1/8"	96"	9 1/2"	6			\$ 1,710	
	DM-9610-A-LB-24	Single Face Adder	24 1/4"	10 1/8"	96"	9 1/2"	6			\$ 1,329	
	DM-9612-S-LB-24	Single Face Starter	25 1/4"	12 1/8"	96"	11 1/2"	6			\$ 1,795	
	DM-9612-A-LB-24	Single Face Adder	24 1/4"	12 1/8"	96"	11 1/2"	6			\$ 1,431	
	DM-9610-S-LB-30	Single Face Starter	31 1/4"	10 1/8"	96"	9 1/2"	6			\$ 1,710	
	DM-9610-A-LB-30	Single Face Adder	30 1/4"	10 1/8"	96"	9 1/2"	6			\$ 1,329	
	DM-9612-S-LB-30	Single Face Starter	31 1/4"	12 1/8"	96"	11 1/2"	6			\$ 1,795	
	DM-9612-A-LB-30	Single Face Adder	30 1/4"	12 1/8"	96"	11 1/2"	6			\$ 1,431	
	DM-9610-S-LB-36	Single Face Starter	37 1/4"	10 1/8"	96"	9 1/2"	6			\$ 1,524	
	DM-9610-A-LB-36	Single Face Adder	36 1/4"	10 1/8"	96"	9 1/2"	6	156 Lbs.	9 Cu Ft	\$ 1,135	
	DM-9612-S-LB-36	Single Face Starter	37 1/4"	12 1/8"	96"	11 1/2"	6	128 Lbs.	8 Cu Ft	\$ 1,610	
	DM-9612-A-LB-36	Single Face Adder	36 1/4"	12 1/8"	96"	11 1/2"	6	177 Lbs.	10 Cu Ft	\$ 1,244	
											
											





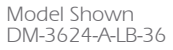

Model Shown  
DM-8212-S-LB-36

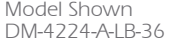



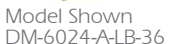

Model Shown  
DM-8212-A-LB-36

Model Shown  
DM-9612-S-LB-36

Model Shown  
DM-9612-A-LB-36

	MODEL NUMBER	PRODUCT	WIDTH	DEPTH	HEIGHT	SHELF DEPTH	# OF SHELVES	# OF OPENINGS	WEIGHT	VOLUME	LIST PRICE	DESCRIPTION
 <p>Model Shown DM-3624-S-LB-36</p>	DM-3620-S-LB-24	Double Face Starter	25 1/4"	19 1/2"	36"	9 1/2"	2	4			\$ 2,301	End, Mid, Top and Base Panels to be constructed from 1" thick 11-ply solid core, veneered 2 sides. Vertical, top and bottom edges banded with 1/4" external hardwood edging, edges to be eased. Front Edge: 3/4" thick x 2 1/2" high fascia - tongue and grooved to top.
	DM-3620-A-LB-24	Double Face Adder	24 1/4"	19 1/2"	36"	9 1/2"	2	4			\$ 1,648	
	DM-3624-S-LB-24	Double Face Starter	25 1/4"	23 1/2"	36"	11 1/2"	2	4			\$ 2,339	
	DM-3624-A-LB-24	Double Face Adder	24 1/4"	23 1/2"	36"	11 1/2"	2	4			\$ 1,664	
 <p>Model Shown DM-3624-A-LB-36</p>	DM-3620-S-LB-30	Double Face Starter	31 1/4"	19 1/2"	36"	9 1/2"	2	4			\$ 2,301	
	DM-3620-A-LB-30	Double Face Adder	30 1/4"	19 1/2"	36"	9 1/2"	2	4			\$ 1,648	
	DM-3624-S-LB-30	Double Face Starter	31 1/4"	23 1/2"	36"	11 1/2"	2	4			\$ 2,339	
	DM-3624-A-LB-30	Double Face Adder	30 1/4"	23 1/2"	36"	11 1/2"	2	4			\$ 1,664	
 <p>Model Shown DM-3624-A-LB-36</p>	DM-3620-S-LB-36	Double Face Starter	37 1/4"	19 1/2"	36"	9 1/2"	2	4	88.6 Lbs.	7 Cu Ft	\$ 2,014	
	DM-3620-A-LB-36	Double Face Adder	36 1/4"	19 1/2"	36"	9 1/2"	2	4	73.6 Lbs.	6 Cu Ft	\$ 1,354	
	DM-3624-S-LB-36	Double Face Starter	37 1/4"	23 1/2"	36"	11 1/2"	2	4	110 Lbs.	10 Cu Ft	\$ 2,060	
	DM-3624-A-LB-36	Double Face Adder	36 1/4"	23 1/2"	36"	11 1/2"	2	4	88.6 Lbs.	9 Cu Ft	\$ 1,375	
 <p>Model Shown DM-4224-S-LB-36</p>	DM-4220-S-LB-24	Double Face Starter	25 1/4"	19 1/2"	42"	9 1/2"	4	6			\$ 2,356	
	DM-4220-A-LB-24	Double Face Adder	24 1/4"	19 1/2"	42"	9 1/2"	4	6			\$ 1,687	
	DM-4224-S-LB-24	Double Face Starter	25 1/4"	23 1/2"	42"	11 1/2"	4	6			\$ 2,401	
	DM-4224-A-LB-24	Double Face Adder	24 1/4"	23 1/2"	42"	11 1/2"	4	6			\$ 1,703	
 <p>Model Shown DM-4224-S-LB-36</p>	DM-4220-S-LB-30	Double Face Starter	31 1/4"	19 1/2"	42"	9 1/2"	4	6			\$ 2,356	
	DM-4220-A-LB-30	Double Face Adder	30 1/4"	19 1/2"	42"	9 1/2"	4	6			\$ 1,687	
	DM-4224-S-LB-30	Double Face Starter	31 1/4"	23 1/2"	42"	11 1/2"	4	6			\$ 2,401	
	DM-4224-A-LB-30	Double Face Adder	30 1/4"	23 1/2"	42"	11 1/2"	4	6			\$ 1,703	
 <p>Model Shown DM-4224-A-LB-36</p>	DM-4220-S-LB-36	Double Face Starter	37 1/4"	19 1/2"	42"	9 1/2"	4	6	94 Lbs.	7 Cu Ft	\$ 2,069	
	DM-4220-A-LB-36	Double Face Adder	36 1/4"	19 1/2"	42"	9 1/2"	4	6	78 Lbs.	7 Cu Ft	\$ 1,393	
	DM-4224-S-LB-36	Double Face Starter	37 1/4"	23 1/2"	42"	11 1/2"	4	6	115 Lbs.	10 Cu Ft	\$ 2,115	
	DM-4224-A-LB-36	Double Face Adder	36 1/4"	23 1/2"	42"	11 1/2"	4	6	113 Lbs.	10 Cu Ft	\$ 1,423	
	DM-4820-S-LB-24	Double Face Starter	25 1/4"	19 1/2"	48"	9 1/2"	4	6			\$ 2,441	
	DM-4820-A-LB-24	Double Face Adder	24 1/4"	19 1/2"	48"	9 1/2"	4	6			\$ 1,958	
	DM-4824-S-LB-24	Double Face Starter	25 1/4"	23 1/2"	48"	11 1/2"	4	6			\$ 2,682	
	DM-4824-A-LB-24	Double Face Adder	24 1/4"	23 1/2"	48"	11 1/2"	4	6			\$ 1,998	
	DM-4820-S-LB-30	Double Face Starter	31 1/4"	19 1/2"	48"	9 1/2"	4	6			\$ 2,441	
	DM-4820-A-LB-30	Double Face Adder	30 1/4"	19 1/2"	48"	9 1/2"	4	6			\$ 1,958	
	DM-4824-S-LB-30	Double Face Starter	31 1/4"	23 1/2"	48"	11 1/2"	4	6			\$ 2,682	
	DM-4824-A-LB-30	Double Face Adder	30 1/4"	23 1/2"	48"	11 1/2"	4	6			\$ 1,998	
	DM-4820-S-LB-36	Double Face Starter	37 1/4"	19 1/2"	48"	9 1/2"	4	6	132 Lbs.	9 Cu Ft	\$ 2,332	
	DM-4820-A-LB-36	Double Face Adder	36 1/4"	19 1/2"	48"	9 1/2"	4	6	109 Lbs.	8 Cu Ft	\$ 1,680	
	DM-4824-S-LB-36	Double Face Starter	37 1/4"	23 1/2"	48"	11 1/2"	4	6	155 Lbs.	11 Cu Ft	\$ 2,387	
	DM-4824-A-LB-36	Double Face Adder	36 1/4"	23 1/2"	48"	11 1/2"	4	6	127 Lbs.	10 Cu Ft	\$ 1,710	

	MODEL NUMBER	PRODUCT	WIDTH	DEPTH	HEIGHT	SHELF DEPTH	# OF SHELVES	# OF OPENINGS	WEIGHT	VOLUME	LIST PRICE	DESCRIPTION
	DM-6020-S-LB-24	Double Face Starter	25 1/4"	19 1/2"	60"	9 1/2"	6	8			\$ 2,712	End, Mid, Top and Base Panels to be constructed from 1" thick 11-ply solid core, veneered 2 sides. Vertical, top and bottom edges banded with 1/4" external hardwood edging, edges to be eased. Front Edge: 3/4" thick x 2 1/2" high fascia - tongue and grooved to top.
	DM-6020-A-LB-24	Double Face Adder	24 1/4"	19 1/2"	60"	9 1/2"	6	8			\$ 2,037	
	DM-6024-S-LB-24	Double Face Starter	25 1/4"	23 1/2"	60"	11 1/2"	6	8			\$ 2,768	
	DM-6024-A-LB-24	Double Face Adder	24 1/4"	23 1/2"	60"	11 1/2"	6	8			\$ 2,100	
	DM-6020-S-LB-30	Double Face Starter	31 1/4"	19 1/2"	60"	9 1/2"	6	8			\$ 2,712	
	DM-6020-A-LB-30	Double Face Adder	30 1/4"	19 1/2"	60"	9 1/2"	6	8			\$ 2,037	
	DM-6024-S-LB-30	Double Face Starter	31 1/4"	23 1/2"	60"	11 1/2"	6	8			\$ 2,768	
	DM-6024-A-LB-30	Double Face Adder	30 1/4"	23 1/2"	60"	11 1/2"	6	8			\$ 2,100	
	DM-6020-S-LB-36	Double Face Starter	37 1/4"	19 1/2"	60"	9 1/2"	6	8	176 Lbs.	11 Cu Ft	\$ 2,433	
	DM-6020-A-LB-36	Double Face Adder	36 1/4"	19 1/2"	60"	9 1/2"	6	8	145 Lbs.	10 Cu Ft	\$ 1,741	
	DM-6024-S-LB-36	Double Face Starter	37 1/4"	23 1/2"	60"	11 1/2"	6	8	200 Lbs.	12 Cu Ft	\$ 2,481	
	DM-6024-A-LB-36	Double Face Adder	36 1/4"	23 1/2"	60"	11 1/2"	6	8	164 Lbs.	11 Cu Ft	\$ 1,811	
	DM-7220-S-LB-24	Double Face Starter	25 1/4"	19 1/2"	72"	9 1/2"	8	10			\$ 2,907	
	DM-7220-A-LB-24	Double Face Adder	24 1/4"	19 1/2"	72"	9 1/2"	8	10			\$ 2,215	
	DM-7224-S-LB-24	Double Face Starter	25 1/4"	23 1/2"	72"	11 1/2"	8	10			\$ 2,970	
	DM-7224-A-LB-24	Double Face Adder	24 1/4"	23 1/2"	72"	11 1/2"	8	10			\$ 2,286	
	DM-7220-S-LB-30	Double Face Starter	31 1/4"	19 1/2"	72"	9 1/2"	8	10			\$ 2,907	
	DM-7220-A-LB-30	Double Face Adder	30 1/4"	19 1/2"	72"	9 1/2"	8	10			\$ 2,215	
	DM-7224-S-LB-30	Double Face Starter	31 1/4"	23 1/2"	72"	11 1/2"	8	10			\$ 2,970	
	DM-7224-A-LB-30	Double Face Adder	30 1/4"	23 1/2"	72"	11 1/2"	8	10			\$ 2,286	
	DM-7220-S-LB-36	Double Face Starter	37 1/4"	19 1/2"	72"	9 1/2"	8	10	200 Lbs.	12 Cu Ft	\$ 2,619	
	DM-7220-A-LB-36	Double Face Adder	36 1/4"	19 1/2"	72"	9 1/2"	8	10	164 Lbs.	11 Cu Ft	\$ 1,929	
	DM-7224-S-LB-36	Double Face Starter	37 1/4"	23 1/2"	72"	11 1/2"	8	10	229 Lbs.	13 Cu Ft	\$ 2,682	
	DM-7224-A-LB-36	Double Face Adder	36 1/4"	23 1/2"	72"	11 1/2"	8	10	186 Lbs.	12 Cu Ft	\$ 1,998	





	MODEL NUMBER	PRODUCT	WIDTH	DEPTH	HEIGHT	SHELF DEPTH	# OF SHELVES	# OF OPENINGS	WEIGHT	VOLUME	LIST PRICE	DESCRIPTION
	DM-8220-S-LB-24	Double Face Starter	25 1/4"	19 1/2"	82"	9 1/2"	10	12			\$ 3,077	End, Mid, Top and Base Panels to be constructed from 1" thick 11-ply solid core, veneered 2 sides. Vertical, top and bottom edges banded with 1/4" external hardwood edging, edges to be eased. Front Edge: 3/4" thick x 2 1/2" high fascia - tongue and grooved to top.
	DM-8220-A-LB-24	Double Face Adder	24 1/4"	19 1/2"	82"	9 1/2"	10	12			\$ 2,401	
	DM-8224-S-LB-24	Double Face Starter	25 1/4"	23 1/2"	82"	11 1/2"	10	12			\$ 3,157	
	DM-8224-A-LB-24	Double Face Adder	24 1/4"	23 1/2"	82"	11 1/2"	10	12			\$ 2,487	
	DM-8220-S-LB-30	Double Face Starter	31 1/4"	19 1/2"	82"	9 1/2"	10	12			\$ 3,077	
	DM-8220-A-LB-30	Double Face Adder	30 1/4"	19 1/2"	82"	9 1/2"	10	12			\$ 2,401	
	DM-8224-S-LB-30	Double Face Starter	31 1/4"	23 1/2"	82"	11 1/2"	10	12			\$ 3,157	
	DM-8224-A-LB-30	Double Face Adder	30 1/4"	23 1/2"	82"	11 1/2"	10	12			\$ 2,487	
	DM-8220-S-LB-36	Double Face Starter	37 1/4"	19 1/2"	82"	9 1/2"	10	12	224 Lbs.	12 Cu Ft	\$ 2,783	
	DM-8220-A-LB-36	Double Face Adder	36 1/4"	19 1/2"	82"	9 1/2"	10	12	184 Lbs.	11 Cu Ft	\$ 2,115	
	DM-8224-S-LB-36	Double Face Starter	37 1/4"	23 1/2"	82"	11 1/2"	10	12	256 Lbs.	14 Cu Ft	\$ 2,876	
	DM-8224-A-LB-36	Double Face Adder	36 1/4"	23 1/2"	82"	11 1/2"	10	12	207 Lbs.	12 Cu Ft	\$ 2,200	
	DM-9620-S-LB-24	Double Face Starter	25 1/4"	19 1/2"	96"	9 1/2"	12	14			\$ 3,265	
	DM-9620-A-LB-24	Double Face Adder	24 1/4"	19 1/2"	96"	9 1/2"	12	14			\$ 2,574	
	DM-9624-S-LB-24	Double Face Starter	25 1/4"	23 1/2"	96"	11 1/2"	12	14			\$ 3,351	
	DM-9624-A-LB-24	Double Face Adder	24 1/4"	23 1/2"	96"	11 1/2"	12	14			\$ 2,682	
	DM-9620-S-LB-30	Double Face Starter	31 1/4"	19 1/2"	96"	9 1/2"	12	14			\$ 3,265	
	DM-9620-A-LB-30	Double Face Adder	30 1/4"	19 1/2"	96"	9 1/2"	12	14			\$ 2,574	
	DM-9624-S-LB-30	Double Face Starter	31 1/4"	23 1/2"	96"	11 1/2"	12	14			\$ 3,351	
	DM-9624-A-LB-30	Double Face Adder	30 1/4"	23 1/2"	96"	11 1/2"	12	14			\$ 2,682	
	DM-9620-S-LB-36	Double Face Starter	37 1/4"	19 1/2"	96"	9 1/2"	12	14	276 Lbs.	13 Cu Ft	\$ 2,970	
	DM-9620-A-LB-36	Double Face Adder	36 1/4"	19 1/2"	96"	9 1/2"	12	14	220 Lbs.	12 Cu Ft	\$ 2,293	
	DM-9624-S-LB-36	Double Face Starter	37 1/4"	23 1/2"	96"	11 1/2"	12	14	315 Lbs.	15 Cu Ft	\$ 3,064	
	DM-9624-A-LB-36	Double Face Adder	36 1/4"	23 1/2"	96"	11 1/2"	12	14	247 Lbs.	13 Cu Ft	\$ 2,387	

Model Shown  
DM-8224-S-LB-36

Model Shown  
DM-8224-A-LB-36

Model Shown  
DM-9624-S-LB-36

Model Shown  
DM-9624-A-LB-36

	MODEL NUMBER	PRODUCT	WIDTH	DEPTH	HEIGHT	SHELF DEPTH	# OF SHELVES	# OF OPENINGS	WEIGHT	VOLUME	LIST PRICE	DESCRIPTION
 Model Shown DM-3612-S-LB-36-IPT   Model Shown DM-3612-A-LB-36-IPT	DM-3610-S-LB-24-IPT	Single Face Starter	25 1/4"	10 1/8"	36"	9 1/2"	1	2			\$ 1,393	End, Mid, Top and Base Panels to be constructed from 1" thick 11-ply solid core, veneered 2 sides. Vertical, top and bottom edges banded with 1/4" external hardwood edging, edges to be eased. Front Edge: 3/4" thick x 2 1/2" high fascia - tongue and grooved to top.
	DM-3610-A-LB-24-IPT	Single Face Adder	24 1/4"	10 1/8"	36"	9 1/2"	1	2			\$ 1,019	
	DM-3612-S-LB-24-IPT	Single Face Starter	25 1/4"	12 1/8"	36"	11 1/2"	1	2			\$ 1,454	
	DM-3612-A-LB-24-IPT	Single Face Adder	24 1/4"	12 1/8"	36"	11 1/2"	1	2			\$ 1,049	
	DM-3610-S-LB-30-IPT	Single Face Starter	31 1/4"	10 1/8"	36"	9 1/2"	1	2			\$ 1,393	
	DM-3610-A-LB-30-IPT	Single Face Adder	30 1/4"	10 1/8"	36"	9 1/2"	1	2			\$ 1,019	
	DM-3612-S-LB-30-IPT	Single Face Starter	31 1/4"	12 1/8"	36"	11 1/2"	1	2			\$ 1,454	
	DM-3612-A-LB-30-IPT	Single Face Adder	30 1/4"	12 1/8"	36"	11 1/2"	1	2			\$ 1,049	
	DM-3610-S-LB-36-IPT	Single Face Starter	37 1/4"	10 1/8"	36"	9 1/2"	1	2	50.6 Lbs.	4 Cu Ft	\$ 1,205	
	DM-3610-A-LB-36-IPT	Single Face Adder	36 1/4"	10 1/8"	36"	9 1/2"	1	2	46 Lbs.	4 Cu Ft	\$ 816	
	DM-3612-S-LB-36-IPT	Single Face Starter	37 1/4"	12 1/8"	36"	11 1/2"	1	2	50.6 Lbs.	5 Cu Ft	\$ 1,259	
	DM-3612-A-LB-36-IPT	Single Face Adder	36 1/4"	12 1/8"	36"	11 1/2"	1	2	47.2 Lbs.	5 Cu Ft	\$ 864	
 Model Shown DM-4212-S-LB-36-IPT   Model Shown DM-4212-A-LB-36-IPT	DM-4210-S-LB-24-IPT	Single Face Starter	25 1/4"	10 1/8"	42"	9 1/2"	2	3			\$ 1,486	
	DM-4210-A-LB-24-IPT	Single Face Adder	24 1/4"	10 1/8"	42"	9 1/2"	2	3			\$ 1,112	
	DM-4212-S-LB-24-IPT	Single Face Starter	25 1/4"	12 1/8"	42"	11 1/2"	2	3			\$ 1,540	
	DM-4212-A-LB-24-IPT	Single Face Adder	24 1/4"	12 1/8"	42"	11 1/2"	2	3			\$ 1,151	
	DM-4210-S-LB-30-IPT	Single Face Starter	31 1/4"	10 1/8"	42"	9 1/2"	2	3			\$ 1,486	
	DM-4210-A-LB-30-IPT	Single Face Adder	30 1/4"	10 1/8"	42"	9 1/2"	2	3			\$ 1,112	
	DM-4212-S-LB-30-IPT	Single Face Starter	31 1/4"	12 1/8"	42"	11 1/2"	2	3			\$ 1,540	
	DM-4212-A-LB-30-IPT	Single Face Adder	30 1/4"	12 1/8"	42"	11 1/2"	2	3			\$ 1,151	
	DM-4210-S-LB-36-IPT	Single Face Starter	37 1/4"	10 1/8"	42"	9 1/2"	2	3	55 Lbs.	5 Cu Ft	\$ 1,298	
	DM-4210-A-LB-36-IPT	Single Face Adder	36 1/4"	10 1/8"	42"	9 1/2"	2	3	52 Lbs.	5 Cu Ft	\$ 887	
	DM-4212-S-LB-36-IPT	Single Face Starter	37 1/4"	12 1/8"	42"	11 1/2"	2	3	60 Lbs.	5 Cu Ft	\$ 1,354	
	DM-4212-A-LB-36-IPT	Single Face Adder	36 1/4"	12 1/8"	42"	11 1/2"	2	3	53 Lbs.	5 Cu Ft	\$ 957	
	DM-4810-S-LB-24-IPT	Single Face Starter	25 1/4"	10 1/8"	48"	9 1/2"	2	3			\$ 1,517	
	DM-4810-A-LB-24-IPT	Single Face Adder	24 1/4"	10 1/8"	48"	9 1/2"	2	3			\$ 1,119	
	DM-4812-S-LB-24-IPT	Single Face Starter	25 1/4"	12 1/8"	48"	11 1/2"	2	3			\$ 1,555	
	DM-4812-A-LB-24-IPT	Single Face Adder	24 1/4"	12 1/8"	48"	11 1/2"	2	3			\$ 1,151	
	DM-4810-S-LB-30-IPT	Single Face Starter	31 1/4"	10 1/8"	48"	9 1/2"	2	3			\$ 1,517	
	DM-4810-A-LB-30-IPT	Single Face Adder	30 1/4"	10 1/8"	48"	9 1/2"	2	3			\$ 1,119	
	DM-4812-S-LB-30-IPT	Single Face Starter	31 1/4"	12 1/8"	48"	11 1/2"	2	3			\$ 1,555	
	DM-4812-A-LB-30-IPT	Single Face Adder	30 1/4"	12 1/8"	48"	11 1/2"	2	3			\$ 1,151	
	DM-4810-S-LB-36-IPT	Single Face Starter	37 1/4"	10 1/8"	48"	9 1/2"	2	3	74.8 Lbs.	5 Cu Ft	\$ 1,323	
	DM-4810-A-LB-36-IPT	Single Face Adder	36 1/4"	10 1/8"	48"	9 1/2"	2	3	65.5 Lbs.	5 Cu Ft	\$ 925	
	DM-4812-S-LB-36-IPT	Single Face Starter	37 1/4"	12 1/8"	48"	11 1/2"	2	3	82.8 Lbs.	6 Cu Ft	\$ 1,369	
	DM-4812-A-LB-36-IPT	Single Face Adder	36 1/4"	12 1/8"	48"	11 1/2"	2	3	71.3 Lbs.	6 Cu Ft	\$ 957	









Model Shown  
DM-6012-S-LB-36-IPT

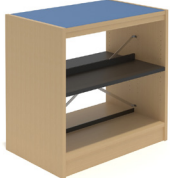
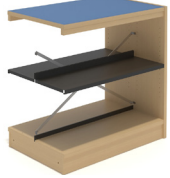

Model Shown  
DM-6012-A-LB-36-IPT

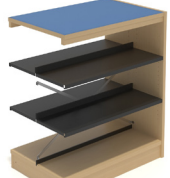
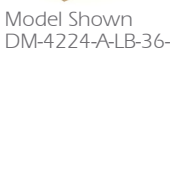
MODEL NUMBER	PRODUCT	WIDTH	DEPTH	HEIGHT	SHELF DEPTH	# OF SHELVES	# OF OPENINGS	WEIGHT	VOLUME	LIST PRICE	DESCRIPTION
DM-6010-S-LB-24-IPT	Single Face Starter	25 1/4"	10 1/8"	60"	9 1/2"	3	4			\$ 1,540	End, Mid, Top and Base Panels to be constructed from 1" thick 11-ply solid core, veneered 2 sides. Vertical, top and bottom edges banded with 1/4" external hardwood edging, edges to be eased. Front Edge: 3/4" thick x 2 1/2" high fascia - tongue and grooved to top.
DM-6010-A-LB-24-IPT	Single Face Adder	24 1/4"	10 1/8"	60"	9 1/2"	3	4			\$ 1,158	
DM-6012-S-LB-24-IPT	Single Face Starter	25 1/4"	12 1/8"	60"	11 1/2"	3	4			\$ 1,578	
DM-6012-A-LB-24-IPT	Single Face Adder	24 1/4"	12 1/8"	60"	11 1/2"	3	4			\$ 1,205	
DM-6010-S-LB-30-IPT	Single Face Starter	31 1/4"	10 1/8"	60"	9 1/2"	3	4			\$ 1,540	
DM-6010-A-LB-30-IPT	Single Face Adder	30 1/4"	10 1/8"	60"	9 1/2"	3	4			\$ 1,158	
DM-6012-S-LB-30-IPT	Single Face Starter	31 1/4"	12 1/8"	60"	11 1/2"	3	4			\$ 1,578	
DM-6012-A-LB-30-IPT	Single Face Adder	30 1/4"	12 1/8"	60"	11 1/2"	3	4			\$ 1,205	
DM-6010-S-LB-36-IPT	Single Face Starter	37 1/4"	10 1/8"	60"	9 1/2"	3	4	100 Lbs.	6 Cu Ft	\$ 1,344	
DM-6010-A-LB-36-IPT	Single Face Adder	36 1/4"	10 1/8"	60"	9 1/2"	3	4	86.3 Lbs.	6 Cu Ft	\$ 964	
DM-6012-S-LB-36-IPT	Single Face Starter	37 1/4"	12 1/8"	60"	11 1/2"	3	4	116 Lbs.	8 Cu Ft	\$ 1,393	
DM-6012-A-LB-36-IPT	Single Face Adder	36 1/4"	12 1/8"	60"	11 1/2"	3	4	95.5 Lbs.	7 Cu Ft	\$ 1,003	

	MODEL NUMBER	PRODUCT	WIDTH	DEPTH	HEIGHT	SHELF DEPTH	# OF SHELVES	# OF OPENINGS	WEIGHT	VOLUME	LIST PRICE	DESCRIPTION
	DM-3620-S-LB-24-IPT	Double Face Starter	25 1/4"	19 1/2"	36"	9 1/2"	2	4			\$ 2,487	End, Mid, Top and Base Panels to be constructed from 1" thick 11-ply solid core, veneered 2 sides. Vertical, top and bottom edges banded with 1/4" external hardwood edging, edges to be eased. Front Edge: 3/4" thick x 2 1/2" high fascia - tongue and grooved to top.
	DM-3620-A-LB-24-IPT	Double Face Adder	24 1/4"	19 1/2"	36"	9 1/2"	2	4			\$ 1,841	
	DM-3624-S-LB-24-IPT	Double Face Starter	25 1/4"	23 1/2"	36"	11 1/2"	2	4			\$ 2,535	
	DM-3624-A-LB-24-IPT	Double Face Adder	24 1/4"	23 1/2"	36"	11 1/2"	2	4			\$ 1,858	
	DM-3620-S-LB-30-IPT	Double Face Starter	31 1/4"	19 1/2"	36"	9 1/2"	2	4			\$ 2,487	
	DM-3620-A-LB-30-IPT	Double Face Adder	30 1/4"	19 1/2"	36"	9 1/2"	2	4			\$ 1,841	
	DM-3624-S-LB-30-IPT	Double Face Starter	31 1/4"	23 1/2"	36"	11 1/2"	2	4			\$ 2,535	
	DM-3624-A-LB-30-IPT	Double Face Adder	30 1/4"	23 1/2"	36"	11 1/2"	2	4			\$ 1,858	
	DM-3620-S-LB-36-IPT	Double Face Starter	37 1/4"	19 1/2"	36"	9 1/2"	2	4	88.6 Lbs.	7 Cu Ft	\$ 2,200	
	DM-3620-A-LB-36-IPT	Double Face Adder	36 1/4"	19 1/2"	36"	9 1/2"	2	4	73.6 Lbs.	6 Cu Ft	\$ 1,547	
	DM-3624-S-LB-36-IPT	Double Face Starter	37 1/4"	23 1/2"	36"	11 1/2"	2	4	110 Lbs.	10 Cu Ft	\$ 2,254	
	DM-3624-A-LB-36-IPT	Double Face Adder	36 1/4"	23 1/2"	36"	11 1/2"	2	4	88.6 Lbs.	9 Cu Ft	\$ 1,571	
	DM-4220-S-LB-24-IPT	Double Face Starter	25 1/4"	19 1/2"	42"	9 1/2"	4	6			\$ 2,551	
	DM-4220-A-LB-24-IPT	Double Face Adder	24 1/4"	19 1/2"	42"	9 1/2"	4	6			\$ 1,881	
	DM-4224-S-LB-24-IPT	Double Face Starter	25 1/4"	23 1/2"	42"	11 1/2"	4	6			\$ 2,605	
	DM-4224-A-LB-24-IPT	Double Face Adder	24 1/4"	23 1/2"	42"	11 1/2"	4	6			\$ 1,897	
	DM-4220-S-LB-30-IPT	Double Face Starter	31 1/4"	19 1/2"	42"	9 1/2"	4	6			\$ 2,551	
	DM-4220-A-LB-30-IPT	Double Face Adder	30 1/4"	19 1/2"	42"	9 1/2"	4	6			\$ 1,881	
	DM-4224-S-LB-30-IPT	Double Face Starter	31 1/4"	23 1/2"	42"	11 1/2"	4	6			\$ 2,605	
	DM-4224-A-LB-30-IPT	Double Face Adder	30 1/4"	23 1/2"	42"	11 1/2"	4	6			\$ 1,897	
	DM-4220-S-LB-36-IPT	Double Face Starter	37 1/4"	19 1/2"	42"	9 1/2"	4	6	94 Lbs.	7 Cu Ft	\$ 2,263	
	DM-4220-A-LB-36-IPT	Double Face Adder	36 1/4"	19 1/2"	42"	9 1/2"	4	6	78 Lbs.	7 Cu Ft	\$ 1,593	
	DM-4224-S-LB-36-IPT	Double Face Starter	37 1/4"	23 1/2"	42"	11 1/2"	4	6	115 Lbs.	10 Cu Ft	\$ 2,309	
	DM-4224-A-LB-36-IPT	Double Face Adder	36 1/4"	23 1/2"	42"	11 1/2"	4	6	113 Lbs.	10 Cu Ft	\$ 1,610	
	DM-4820-S-LB-24-IPT	Double Face Starter	25 1/4"	19 1/2"	48"	9 1/2"	4	6			\$ 2,636	
	DM-4820-A-LB-24-IPT	Double Face Adder	24 1/4"	19 1/2"	48"	9 1/2"	4	6			\$ 2,153	
	DM-4824-S-LB-24-IPT	Double Face Starter	25 1/4"	23 1/2"	48"	11 1/2"	4	6			\$ 2,876	
	DM-4824-A-LB-24-IPT	Double Face Adder	24 1/4"	23 1/2"	48"	11 1/2"	4	6			\$ 2,184	
	DM-4820-S-LB-30-IPT	Double Face Starter	31 1/4"	19 1/2"	48"	9 1/2"	4	6			\$ 2,636	
	DM-4820-A-LB-30-IPT	Double Face Adder	30 1/4"	19 1/2"	48"	9 1/2"	4	6			\$ 2,153	
	DM-4824-S-LB-30-IPT	Double Face Starter	31 1/4"	23 1/2"	48"	11 1/2"	4	6			\$ 2,876	
	DM-4824-A-LB-30-IPT	Double Face Adder	30 1/4"	23 1/2"	48"	11 1/2"	4	6			\$ 2,184	
	DM-4820-S-LB-36-IPT	Double Face Starter	37 1/4"	19 1/2"	48"	9 1/2"	4	6	132 Lbs.	9 Cu Ft	\$ 2,527	
	DM-4820-A-LB-36-IPT	Double Face Adder	36 1/4"	19 1/2"	48"	9 1/2"	4	6	109 Lbs.	8 Cu Ft	\$ 1,873	
	DM-4824-S-LB-36-IPT	Double Face Starter	37 1/4"	23 1/2"	48"	11 1/2"	4	6	155 Lbs.	11 Cu Ft	\$ 2,581	
	DM-4824-A-LB-36-IPT	Double Face Adder	36 1/4"	23 1/2"	48"	11 1/2"	4	6	127 Lbs.	10 Cu Ft	\$ 1,904	











Model Shown  
DM-6024-S-LB-36-IPT



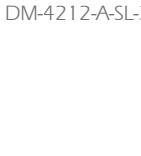







Model Shown  
DM-6024-A-LB-36-IPT





MODEL NUMBER	PRODUCT	WIDTH	DEPTH	HEIGHT	SHELF DEPTH	# OF SHELVES	# OF OPENINGS	WEIGHT	VOLUME	LIST PRICE	DESCRIPTION
DM-6020-S-LB-24-IPT	Double Face Starter	25 1/4"	19 1/2"	60"	9 1/2"	6	8			\$ 2,907	End, Mid, Top and Base Panels to be constructed from 1" thick 11-ply solid core, veneered 2 sides. Vertical, top and bottom edges banded with 1/4" external hardwood edging, edges to be eased. Front Edge: 3/4" thick x 2 1/2" high fascia - tongue and grooved to top.
DM-6020-A-LB-24-IPT	Double Face Adder	24 1/4"	19 1/2"	60"	9 1/2"	6	8			\$ 2,231	
DM-6024-S-LB-24-IPT	Double Face Starter	25 1/4"	23 1/2"	60"	11 1/2"	6	8			\$ 2,961	
DM-6024-A-LB-24-IPT	Double Face Adder	24 1/4"	23 1/2"	60"	11 1/2"	6	8			\$ 2,293	
DM-6020-S-LB-30-IPT	Double Face Starter	31 1/4"	19 1/2"	60"	9 1/2"	6	8			\$ 2,907	
DM-6020-A-LB-30-IPT	Double Face Adder	30 1/4"	19 1/2"	60"	9 1/2"	6	8			\$ 2,231	
DM-6024-S-LB-30-IPT	Double Face Starter	31 1/4"	23 1/2"	60"	11 1/2"	6	8			\$ 2,961	
DM-6024-A-LB-30-IPT	Double Face Adder	30 1/4"	23 1/2"	60"	11 1/2"	6	8			\$ 2,293	
DM-6020-S-LB-36-IPT	Double Face Starter	37 1/4"	19 1/2"	60"	9 1/2"	6	8	176 Lbs.	11 Cu Ft	\$ 2,619	
DM-6020-A-LB-36-IPT	Double Face Adder	36 1/4"	19 1/2"	60"	9 1/2"	6	8	145 Lbs.	10 Cu Ft	\$ 1,935	
DM-6024-S-LB-36-IPT	Double Face Starter	37 1/4"	23 1/2"	60"	11 1/2"	6	8	200 Lbs.	12 Cu Ft	\$ 2,675	
DM-6024-A-LB-36-IPT	Double Face Adder	36 1/4"	23 1/2"	60"	11 1/2"	6	8	164 Lbs.	11 Cu Ft	\$ 1,998	

	MODEL NUMBER	PRODUCT	WIDTH	DEPTH	HEIGHT	SHELF DEPTH	# OF SHELVES	# OF OPENINGS	WEIGHT	VOLUME	LIST PRICE	DESCRIPTION
 Model Shown DM-3610-S-SL-24	DM-3610-S-SL-24	Single Face Starter	25 1/4"	10 1/8"	36"	9 1/2"	1	2			\$ 1,493	End, Mid, Top and Base Panels to be constructed from 1" thick 11-ply solid core, veneered 2 sides. Vertical, top and bottom edges banded with 1/4" external hardwood edging, edges to be eased. Front Edge: 3/4" thick x 2 1/2" high fascia - tongue and grooved to top.
	DM-3610-A-SL-24	Single Face Adder	24 1/4"	10 1/8"	36"	9 1/2"	1	2			\$ 1,119	
	DM-3612-S-SL-24	Single Face Starter	25 1/4"	12 1/8"	36"	11 1/2"	1	2			\$ 1,555	
	DM-3612-A-SL-24	Single Face Adder	24 1/4"	12 1/8"	36"	11 1/2"	1	2			\$ 1,151	
 Model Shown DM-3612-S-SL-36	DM-3610-S-SL-30	Single Face Starter	31 1/4"	10 1/8"	36"	9 1/2"	1	2			\$ 1,493	
	DM-3610-A-SL-30	Single Face Adder	30 1/4"	10 1/8"	36"	9 1/2"	1	2			\$ 1,119	
	DM-3612-S-SL-30	Single Face Starter	31 1/4"	12 1/8"	36"	11 1/2"	1	2			\$ 1,555	
	DM-3612-A-SL-30	Single Face Adder	30 1/4"	12 1/8"	36"	11 1/2"	1	2			\$ 1,151	
 Model Shown DM-3612-A-SL-36	DM-3610-S-SL-36	Single Face Starter	37 1/4"	10 1/8"	36"	9 1/2"	1	2	50.6 Lbs.	4 Cu Ft	\$ 1,306	
	DM-3610-A-SL-36	Single Face Adder	36 1/4"	10 1/8"	36"	9 1/2"	1	2	46 Lbs.	4 Cu Ft	\$ 925	
	DM-3612-S-SL-36	Single Face Starter	37 1/4"	12 1/8"	36"	11 1/2"	1	2	50.6 Lbs.	5 Cu Ft	\$ 1,360	
	DM-3612-A-SL-36	Single Face Adder	36 1/4"	12 1/8"	36"	11 1/2"	1	2	47.2 Lbs.	5 Cu Ft	\$ 964	
 Model Shown DM-4210-S-SL-24	DM-4210-S-SL-24	Single Face Starter	25 1/4"	10 1/8"	42"	9 1/2"	2	3			\$ 1,873	
	DM-4210-A-SL-24	Single Face Adder	24 1/4"	10 1/8"	42"	9 1/2"	2	3			\$ 1,500	
	DM-4212-S-SL-24	Single Face Starter	25 1/4"	12 1/8"	42"	11 1/2"	2	3			\$ 1,929	
	DM-4212-A-SL-24	Single Face Adder	24 1/4"	12 1/8"	42"	11 1/2"	2	3			\$ 1,540	
 Model Shown DM-4212-S-SL-36	DM-4210-S-SL-30	Single Face Starter	31 1/4"	10 1/8"	42"	9 1/2"	2	3			\$ 1,873	
	DM-4210-A-SL-30	Single Face Adder	30 1/4"	10 1/8"	42"	9 1/2"	2	3			\$ 1,500	
	DM-4212-S-SL-30	Single Face Starter	31 1/4"	12 1/8"	42"	11 1/2"	2	3			\$ 1,929	
	DM-4212-A-SL-30	Single Face Adder	30 1/4"	12 1/8"	42"	11 1/2"	2	3			\$ 1,540	
 Model Shown DM-4212-A-SL-36	DM-4210-S-SL-36	Single Face Starter	37 1/4"	10 1/8"	42"	9 1/2"	2	3	55 Lbs.	5 Cu Ft	\$ 1,687	
	DM-4210-A-SL-36	Single Face Adder	36 1/4"	10 1/8"	42"	9 1/2"	2	3	52 Lbs.	5 Cu Ft	\$ 1,275	
	DM-4212-S-SL-36	Single Face Starter	37 1/4"	12 1/8"	42"	11 1/2"	2	3	60 Lbs.	5 Cu Ft	\$ 1,741	
	DM-4212-A-SL-36	Single Face Adder	36 1/4"	12 1/8"	42"	11 1/2"	2	3	53 Lbs.	5 Cu Ft	\$ 1,344	
	DM-4810-S-SL-24	Single Face Starter	25 1/4"	10 1/8"	48"	9 1/2"	2	3			\$ 1,904	
	DM-4810-A-SL-24	Single Face Adder	24 1/4"	10 1/8"	48"	9 1/2"	2	3			\$ 1,508	
	DM-4812-S-SL-24	Single Face Starter	25 1/4"	12 1/8"	48"	11 1/2"	2	3			\$ 1,945	
	DM-4812-A-SL-24	Single Face Adder	24 1/4"	12 1/8"	48"	11 1/2"	2	3			\$ 1,540	
	DM-4810-S-SL-30	Single Face Starter	31 1/4"	10 1/8"	48"	9 1/2"	2	3			\$ 1,904	
	DM-4810-A-SL-30	Single Face Adder	30 1/4"	10 1/8"	48"	9 1/2"	2	3			\$ 1,508	
	DM-4812-S-SL-30	Single Face Starter	31 1/4"	12 1/8"	48"	11 1/2"	2	3			\$ 1,945	
	DM-4812-A-SL-30	Single Face Adder	30 1/4"	12 1/8"	48"	11 1/2"	2	3			\$ 1,540	
	DM-4810-S-SL-36	Single Face Starter	37 1/4"	10 1/8"	48"	9 1/2"	2	3	74.8 Lbs.	5 Cu Ft	\$ 1,710	
	DM-4810-A-SL-36	Single Face Adder	36 1/4"	10 1/8"	48"	9 1/2"	2	3	65.5 Lbs.	5 Cu Ft	\$ 1,313	
	DM-4812-S-SL-36	Single Face Starter	37 1/4"	12 1/8"	48"	11 1/2"	2	3	82.8 Lbs.	6 Cu Ft	\$ 1,757	
	DM-4812-A-SL-36	Single Face Adder	36 1/4"	12 1/8"	48"	11 1/2"	2	3	71.3 Lbs.	6 Cu Ft	\$ 1,344	





	MODEL NUMBER	PRODUCT	WIDTH	DEPTH	HEIGHT	SHELF DEPTH	# OF SHELVES	# OF OPENINGS	WEIGHT	VOLUME	LIST PRICE	DESCRIPTION	
 <p>Model Shown DM-6012-S-SL-36</p>	DM-6010-S-SL-24	Single Face Starter	25 1/4"	10 1/8"	60"	9 1/2"	3	4			\$ 2,091	End, Mid, Top and Base Panels to be constructed from 1" thick 11-ply solid core, veneered 2 sides. Vertical, top and bottom edges banded with 1/4" external hardwood edging, edges to be eased. Front Edge: 3/4" thick x 2 1/2" high fascia - tongue and grooved to top.	
	DM-6010-A-SL-24	Single Face Adder	24 1/4"	10 1/8"	60"	9 1/2"	3	4			\$ 1,710		
	DM-6012-S-SL-24	Single Face Starter	25 1/4"	12 1/8"	60"	11 1/2"	3	4			\$ 2,139		
	DM-6012-A-SL-24	Single Face Adder	24 1/4"	12 1/8"	60"	11 1/2"	3	4			\$ 1,748		
	DM-6010-S-SL-30	Single Face Starter	31 1/4"	10 1/8"	60"	9 1/2"	3	4			\$ 2,091		
	DM-6010-A-SL-30	Single Face Adder	30 1/4"	10 1/8"	60"	9 1/2"	3	4			\$ 1,710		
	DM-6012-S-SL-30	Single Face Starter	31 1/4"	12 1/8"	60"	11 1/2"	3	4			\$ 2,139		
	DM-6012-A-SL-30	Single Face Adder	30 1/4"	12 1/8"	60"	11 1/2"	3	4			\$ 1,748		
 <p>Model Shown DM-6012-A-SL-36</p>	DM-6010-S-SL-36	Single Face Starter	37 1/4"	10 1/8"	60"	9 1/2"	3	4	100 Lbs.	6 Cu Ft	\$ 1,897		
	DM-6010-A-SL-36	Single Face Adder	36 1/4"	10 1/8"	60"	9 1/2"	3	4	86.3 Lbs.	6 Cu Ft	\$ 1,517		
	DM-6012-S-SL-36	Single Face Starter	37 1/4"	12 1/8"	60"	11 1/2"	3	4	116 Lbs.	8 Cu Ft	\$ 1,945		
	DM-6012-A-SL-36	Single Face Adder	36 1/4"	12 1/8"	60"	11 1/2"	3	4	95.5 Lbs.	7 Cu Ft	\$ 1,555		
 <p>Model Shown DM-7212-S-SL-36</p>	DM-7210-S-SL-24	Single Face Starter	25 1/4"	10 1/8"	72"	9 1/2"	4	5			\$ 2,339		
	DM-7210-A-SL-24	Single Face Adder	24 1/4"	10 1/8"	72"	9 1/2"	4	5			\$ 1,958		
	DM-7212-S-SL-24	Single Face Starter	25 1/4"	12 1/8"	72"	11 1/2"	4	5			\$ 2,401		
	DM-7212-A-SL-24	Single Face Adder	24 1/4"	12 1/8"	72"	11 1/2"	4	5			\$ 2,014		
	DM-7210-S-SL-30	Single Face Starter	31 1/4"	10 1/8"	72"	9 1/2"	4	5			\$ 2,339		
	DM-7210-A-SL-30	Single Face Adder	30 1/4"	10 1/8"	72"	9 1/2"	4	5			\$ 1,958		
	DM-7212-S-SL-30	Single Face Starter	31 1/4"	12 1/8"	72"	11 1/2"	4	5			\$ 2,401		
	DM-7212-A-SL-30	Single Face Adder	30 1/4"	12 1/8"	72"	11 1/2"	4	5			\$ 2,014		
	 <p>Model Shown DM-7212-A-SL-36</p>	DM-7210-S-SL-36	Single Face Starter	37 1/4"	10 1/8"	72"	9 1/2"	4	5	115 Lbs.	7 Cu Ft		\$ 2,146
		DM-7210-A-SL-36	Single Face Adder	36 1/4"	10 1/8"	72"	9 1/2"	4	5	96.6 Lbs.	7 Cu Ft		\$ 1,765
		DM-7212-S-SL-36	Single Face Starter	37 1/4"	12 1/8"	72"	11 1/2"	4	5	131 Lbs.	8 Cu Ft		\$ 2,215
		DM-7212-A-SL-36	Single Face Adder	36 1/4"	12 1/8"	72"	11 1/2"	4	5	109 Lbs.	8 Cu Ft		\$ 1,827







MODEL NUMBER	PRODUCT	WIDTH	DEPTH	HEIGHT	SHELF DEPTH	# OF SHELVES	# OF OPENINGS	WEIGHT	VOLUME	LIST PRICE	DESCRIPTION	
 Model Shown DM-8210-S-SL-36	DM-8210-S-SL-24	Single Face Starter	25 1/4"	10 1/8"	82"	9 1/2"	5			\$ 2,588	End, Mid, Top and Base Panels to be constructed from 1" thick 11-ply solid core, veneered 2 sides. Vertical, top and bottom edges banded with 1/4" external hardwood edging, edges to be eased. Front Edge: 3/4" thick x 2 1/2" high fascia - tongue and grooved to top.	
	DM-8210-A-SL-24	Single Face Adder	24 1/4"	10 1/8"	82"	9 1/2"	5			\$ 2,215		
	DM-8212-S-SL-24	Single Face Starter	25 1/4"	12 1/8"	82"	11 1/2"	5			\$ 2,666		
	DM-8212-A-SL-24	Single Face Adder	24 1/4"	12 1/8"	82"	11 1/2"	5			\$ 2,270		
	DM-8210-S-SL-30	Single Face Starter	31 1/4"	10 1/8"	82"	9 1/2"	5			\$ 2,588		
	DM-8210-A-SL-30	Single Face Adder	30 1/4"	10 1/8"	82"	9 1/2"	5			\$ 2,215		
	DM-8212-S-SL-30	Single Face Starter	31 1/4"	12 1/8"	82"	11 1/2"	5			\$ 2,666		
	DM-8212-A-SL-30	Single Face Adder	30 1/4"	12 1/8"	82"	11 1/2"	5			\$ 2,270		
	DM-8210-S-SL-36	Single Face Starter	37 1/4"	10 1/8"	82"	9 1/2"	5	6	129 Lbs.	8 Cu Ft		\$ 2,401
	DM-8210-A-SL-36	Single Face Adder	36 1/4"	10 1/8"	82"	9 1/2"	5	6	107 Lbs.	7 Cu Ft		\$ 2,029
	DM-8212-S-SL-36	Single Face Starter	37 1/4"	12 1/8"	82"	11 1/2"	5	6	145 Lbs.	9 Cu Ft		\$ 2,473
	DM-8212-A-SL-36	Single Face Adder	36 1/4"	12 1/8"	82"	11 1/2"	5	6	122 Lbs.	8 Cu Ft		\$ 2,083
 Model Shown DM-8212-A-SL-36	DM-9610-S-SL-24	Single Face Starter	25 1/4"	10 1/8"	96"	9 1/2"	6			\$ 2,846		
	DM-9610-A-SL-24	Single Face Adder	24 1/4"	10 1/8"	96"	9 1/2"	6			\$ 2,463		
	DM-9612-S-SL-24	Single Face Starter	25 1/4"	12 1/8"	96"	11 1/2"	6			\$ 2,930		
	DM-9612-A-SL-24	Single Face Adder	24 1/4"	12 1/8"	96"	11 1/2"	6			\$ 2,558		
	DM-9610-S-SL-30	Single Face Starter	31 1/4"	10 1/8"	96"	9 1/2"	6			\$ 2,846		
	DM-9610-A-SL-30	Single Face Adder	30 1/4"	10 1/8"	96"	9 1/2"	6			\$ 2,463		
	DM-9612-S-SL-30	Single Face Starter	31 1/4"	12 1/8"	96"	11 1/2"	6			\$ 2,930		
	DM-9612-A-SL-30	Single Face Adder	30 1/4"	12 1/8"	96"	11 1/2"	6			\$ 2,574		
	DM-9610-S-SL-36	Single Face Starter	37 1/4"	10 1/8"	96"	9 1/2"	6	7	156 Lbs.	9 Cu Ft	\$ 2,659	
	DM-9610-A-SL-36	Single Face Adder	36 1/4"	10 1/8"	96"	9 1/2"	6	7	128 Lbs.	8 Cu Ft	\$ 2,270	
	DM-9612-S-SL-36	Single Face Starter	37 1/4"	12 1/8"	96"	11 1/2"	6	7	177 Lbs.	10 Cu Ft	\$ 2,736	
	DM-9612-A-SL-36	Single Face Adder	36 1/4"	12 1/8"	96"	11 1/2"	6	7	145 Lbs.	9 Cu Ft	\$ 2,370	
 Model Shown DM-9612-A-SL-36												

	MODEL NUMBER	PRODUCT	WIDTH	DEPTH	HEIGHT	SHELF DEPTH	# OF SHELVES	# OF OPENINGS	WEIGHT	VOLUME	LIST PRICE	DESCRIPTION
 Model Shown DM-3624-S-SL-36-SB	DM-3620-S-SL-24-SB	Double Face Starter	25 1/4"	19 1/2"	36"	9 1/2"	2	4			\$ 2,705	End, Mid, Top and Base Panels to be constructed from 1" thick 11-ply solid core, veneered 2 sides. Vertical, top and bottom edges banded with 1/4" external hardwood edging, edges to be eased. Front Edge: 3/4" thick x 2 1/2" high fascia - tongue and grooved to top.
	DM-3620-A-SL-24-SB	Double Face Adder	24 1/4"	19 1/2"	36"	9 1/2"	2	4			\$ 2,053	
	DM-3624-S-SL-24-SB	Double Face Starter	25 1/4"	23 1/2"	36"	11 1/2"	2	4			\$ 2,744	
	DM-3624-A-SL-24-SB	Double Face Adder	24 1/4"	23 1/2"	36"	11 1/2"	2	4			\$ 2,069	
 Model Shown DM-3624-S-SL-36-SB	DM-3620-S-SL-30-SB	Double Face Starter	31 1/4"	19 1/2"	36"	9 1/2"	2	4			\$ 2,705	
	DM-3620-A-SL-30-SB	Double Face Adder	30 1/4"	19 1/2"	36"	9 1/2"	2	4			\$ 2,053	
	DM-3624-S-SL-30-SB	Double Face Starter	31 1/4"	23 1/2"	36"	11 1/2"	2	4			\$ 2,744	
	DM-3624-A-SL-30-SB	Double Face Adder	30 1/4"	23 1/2"	36"	11 1/2"	2	4			\$ 2,069	
 Model Shown DM-3624-A-SL-36-SB	DM-3620-S-SL-36-SB	Double Face Starter	37 1/4"	19 1/2"	36"	9 1/2"	2	4	88.6 Lbs.	7 Cu Ft	\$ 2,417	
	DM-3620-A-SL-36-SB	Double Face Adder	36 1/4"	19 1/2"	36"	9 1/2"	2	4	73.6 Lbs.	6 Cu Ft	\$ 1,757	
	DM-3624-S-SL-36-SB	Double Face Starter	37 1/4"	23 1/2"	36"	11 1/2"	2	4	110 Lbs.	10 Cu Ft	\$ 2,463	
	DM-3624-A-SL-36-SB	Double Face Adder	36 1/4"	23 1/2"	36"	11 1/2"	2	4	88.6 Lbs.	9 Cu Ft	\$ 1,780	
 Model Shown DM-4224-S-SL-36-SB	DM-4220-S-SL-24-SB	Double Face Starter	25 1/4"	19 1/2"	42"	9 1/2"	4	6			\$ 3,164	
	DM-4220-A-SL-24-SB	Double Face Adder	24 1/4"	19 1/2"	42"	9 1/2"	4	6			\$ 2,494	
	DM-4224-S-SL-24-SB	Double Face Starter	25 1/4"	23 1/2"	42"	11 1/2"	4	6			\$ 3,210	
	DM-4224-A-SL-24-SB	Double Face Adder	24 1/4"	23 1/2"	42"	11 1/2"	4	6			\$ 2,512	
 Model Shown DM-4224-S-SL-36-SB	DM-4220-S-SL-30-SB	Double Face Starter	31 1/4"	19 1/2"	42"	9 1/2"	4	6			\$ 3,164	
	DM-4220-A-SL-30-SB	Double Face Adder	30 1/4"	19 1/2"	42"	9 1/2"	4	6			\$ 2,494	
	DM-4224-S-SL-30-SB	Double Face Starter	31 1/4"	23 1/2"	42"	11 1/2"	4	6			\$ 3,210	
	DM-4224-A-SL-30-SB	Double Face Adder	30 1/4"	23 1/2"	42"	11 1/2"	4	6			\$ 2,512	
 Model Shown DM-4224-A-SL-36-SB	DM-4220-S-SL-36-SB	Double Face Starter	37 1/4"	19 1/2"	42"	9 1/2"	4	6	94 Lbs.	7 Cu Ft	\$ 2,876	
	DM-4220-A-SL-36-SB	Double Face Adder	36 1/4"	19 1/2"	42"	9 1/2"	4	6	78 Lbs.	7 Cu Ft	\$ 2,200	
	DM-4224-S-SL-36-SB	Double Face Starter	37 1/4"	23 1/2"	42"	11 1/2"	4	6	115 Lbs.	10 Cu Ft	\$ 2,923	
	DM-4224-A-SL-36-SB	Double Face Adder	36 1/4"	23 1/2"	42"	11 1/2"	4	6	113 Lbs.	10 Cu Ft	\$ 2,231	
	DM-4820-S-SL-24-SB	Double Face Starter	25 1/4"	19 1/2"	48"	9 1/2"	4	6			\$ 3,250	
	DM-4820-A-SL-24-SB	Double Face Adder	24 1/4"	19 1/2"	48"	9 1/2"	4	6			\$ 2,768	
	DM-4824-S-SL-24-SB	Double Face Starter	25 1/4"	23 1/2"	48"	11 1/2"	4	6			\$ 3,490	
	DM-4824-A-SL-24-SB	Double Face Adder	24 1/4"	23 1/2"	48"	11 1/2"	4	6			\$ 2,806	
	DM-4820-S-SL-30-SB	Double Face Starter	31 1/4"	19 1/2"	48"	9 1/2"	4	6			\$ 3,250	
	DM-4820-A-SL-30-SB	Double Face Adder	30 1/4"	19 1/2"	48"	9 1/2"	4	6			\$ 2,768	
	DM-4824-S-SL-30-SB	Double Face Starter	31 1/4"	23 1/2"	48"	11 1/2"	4	6			\$ 3,490	
	DM-4824-A-SL-30-SB	Double Face Adder	30 1/4"	23 1/2"	48"	11 1/2"	4	6			\$ 2,806	
	DM-4820-S-SL-36-SB	Double Face Starter	37 1/4"	19 1/2"	48"	9 1/2"	4	6	132 Lbs.	9 Cu Ft	\$ 3,141	
	DM-4820-A-SL-36-SB	Double Face Adder	36 1/4"	19 1/2"	48"	9 1/2"	4	6	109 Lbs.	8 Cu Ft	\$ 2,487	
	DM-4824-S-SL-36-SB	Double Face Starter	37 1/4"	23 1/2"	48"	11 1/2"	4	6	155 Lbs.	11 Cu Ft	\$ 3,195	
	DM-4824-A-SL-36-SB	Double Face Adder	36 1/4"	23 1/2"	48"	11 1/2"	4	6	127 Lbs.	10 Cu Ft	\$ 2,519	

	MODEL NUMBER	PRODUCT	WIDTH	DEPTH	HEIGHT	SHELF DEPTH	# OF SHELVES	# OF OPENINGS	WEIGHT	VOLUME	LIST PRICE	DESCRIPTION
 <p>Model Shown DM-6024-S-SL-36-SB</p>	DM-6020-S-SL-24-SB	Double Face Starter	25 1/4"	19 1/2"	60"	9 1/2"	6	8			\$ 3,848	End, Mid, Top and Base Panels to be constructed from 1" thick 11-ply solid core, veneered 2 sides. Vertical, top and bottom edges banded with 1/4" external hardwood edging, edges to be eased. Front Edge: 3/4" thick x 2 1/2" high fascia - tongue and grooved to top.
	DM-6020-A-SL-24-SB	Double Face Adder	24 1/4"	19 1/2"	60"	9 1/2"	6	8			\$ 3,164	
	DM-6024-S-SL-24-SB	Double Face Starter	25 1/4"	23 1/2"	60"	11 1/2"	6	8			\$ 3,903	
	DM-6024-A-SL-24-SB	Double Face Adder	24 1/4"	23 1/2"	60"	11 1/2"	6	8			\$ 3,234	
	DM-6020-S-SL-30-SB	Double Face Starter	31 1/4"	19 1/2"	60"	9 1/2"	6	8			\$ 3,848	
	DM-6020-A-SL-30-SB	Double Face Adder	30 1/4"	19 1/2"	60"	9 1/2"	6	8			\$ 3,164	
	DM-6024-S-SL-30-SB	Double Face Starter	31 1/4"	23 1/2"	60"	11 1/2"	6	8			\$ 3,903	
	DM-6024-A-SL-30-SB	Double Face Adder	30 1/4"	23 1/2"	60"	11 1/2"	6	8			\$ 3,234	
 <p>Model Shown DM-6024-A-SL-36-SB</p>	DM-6020-S-SL-36-SB	Double Face Starter	37 1/4"	19 1/2"	60"	9 1/2"	6	8	176 Lbs.	11 Cu Ft	\$ 3,560	
	DM-6020-A-SL-36-SB	Double Face Adder	36 1/4"	19 1/2"	60"	9 1/2"	6	8	145 Lbs.	10 Cu Ft	\$ 2,876	
	DM-6024-S-SL-36-SB	Double Face Starter	37 1/4"	23 1/2"	60"	11 1/2"	6	8	200 Lbs.	12 Cu Ft	\$ 3,614	
	DM-6024-A-SL-36-SB	Double Face Adder	36 1/4"	23 1/2"	60"	11 1/2"	6	8	164 Lbs.	11 Cu Ft	\$ 2,939	
 <p>Model Shown DM-7224-S-SL-36-SB</p>	DM-7220-S-SL-24-SB	Double Face Starter	25 1/4"	19 1/2"	72"	9 1/2"	8	10			\$ 4,361	
	DM-7220-A-SL-24-SB	Double Face Adder	24 1/4"	19 1/2"	72"	9 1/2"	8	10			\$ 3,677	
	DM-7224-S-SL-24-SB	Double Face Starter	25 1/4"	23 1/2"	72"	11 1/2"	8	10			\$ 4,423	
	DM-7224-A-SL-24-SB	Double Face Adder	24 1/4"	23 1/2"	72"	11 1/2"	8	10			\$ 3,739	
		DM-7220-S-SL-30-SB	Double Face Starter	31 1/4"	19 1/2"	72"	9 1/2"	8	10			\$ 4,361
		DM-7220-A-SL-30-SB	Double Face Adder	30 1/4"	19 1/2"	72"	9 1/2"	8	10			\$ 3,677
		DM-7224-S-SL-30-SB	Double Face Starter	31 1/4"	23 1/2"	72"	11 1/2"	8	10			\$ 4,423
		DM-7224-A-SL-30-SB	Double Face Adder	30 1/4"	23 1/2"	72"	11 1/2"	8	10			\$ 3,739
 <p>Model Shown DM-7224-A-SL-36-SB</p>	DM-7220-S-SL-36-SB	Double Face Starter	37 1/4"	19 1/2"	72"	9 1/2"	8	10	200 Lbs.	12 Cu Ft	\$ 4,073	
	DM-7220-A-SL-36-SB	Double Face Adder	36 1/4"	19 1/2"	72"	9 1/2"	8	10	164 Lbs.	11 Cu Ft	\$ 3,382	
	DM-7224-S-SL-36-SB	Double Face Starter	37 1/4"	23 1/2"	72"	11 1/2"	8	10	229 Lbs.	13 Cu Ft	\$ 4,135	
	DM-7224-A-SL-36-SB	Double Face Adder	36 1/4"	23 1/2"	72"	11 1/2"	8	10	186 Lbs.	12 Cu Ft	\$ 3,451	

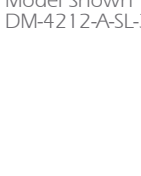

MODEL NUMBER	PRODUCT	WIDTH	DEPTH	HEIGHT	SHELF DEPTH	# OF SHELVES	# OF OPENINGS	WEIGHT	VOLUME	LIST PRICE	DESCRIPTION	
 <p>Model Shown DM-8224-S-SL-36-SB</p>  <p>Model Shown DM-8224-A-SL-36-SB</p>  <p>Model Shown DM-9624-S-SL-36-SB</p>  <p>Model Shown DM-9624-A-SL-36-SB</p>	DM-8220-S-SL-24-SB	Double Face Starter	25 1/4"	19 1/2"	82"	9 1/2"	10			\$ 4,694	End, Mid, Top and Base Panels to be constructed from 1" thick 11-ply solid core, veneered 2 sides. Vertical, top and bottom edges banded with 1/4" external hardwood edging, edges to be eased. Front Edge: 3/4" thick x 2 1/2" high fascia - tongue and grooved to top.	
	DM-8220-A-SL-24-SB	Double Face Adder	24 1/4"	19 1/2"	82"	9 1/2"	10			\$ 4,018		
	DM-8224-S-SL-24-SB	Double Face Starter	25 1/4"	23 1/2"	82"	11 1/2"	10			\$ 4,774		
	DM-8224-A-SL-24-SB	Double Face Adder	24 1/4"	23 1/2"	82"	11 1/2"	10			\$ 4,104		
	DM-8220-S-SL-30-SB	Double Face Starter	31 1/4"	19 1/2"	82"	9 1/2"	10			\$ 4,694		
	DM-8220-A-SL-30-SB	Double Face Adder	30 1/4"	19 1/2"	82"	9 1/2"	10			\$ 4,018		
	DM-8224-S-SL-30-SB	Double Face Starter	31 1/4"	23 1/2"	82"	11 1/2"	10			\$ 4,774		
	DM-8224-A-SL-30-SB	Double Face Adder	30 1/4"	23 1/2"	82"	11 1/2"	10			\$ 4,104		
	DM-8220-S-SL-36-SB	Double Face Starter	37 1/4"	19 1/2"	82"	9 1/2"	10	12	224 Lbs.	12 Cu Ft		\$ 4,408
	DM-8220-A-SL-36-SB	Double Face Adder	36 1/4"	19 1/2"	82"	9 1/2"	10	12	184 Lbs.	11 Cu Ft		\$ 3,732
	DM-8224-S-SL-36-SB	Double Face Starter	37 1/4"	23 1/2"	82"	11 1/2"	10	12	256 Lbs.	14 Cu Ft		\$ 4,493
	DM-8224-A-SL-36-SB	Double Face Adder	36 1/4"	23 1/2"	82"	11 1/2"	10	12	207 Lbs.	12 Cu Ft		\$ 3,817
DM-9620-S-SL-24-SB	Double Face Starter	25 1/4"	19 1/2"	96"	9 1/2"	12	14			\$ 5,045		
DM-9620-A-SL-24-SB	Double Face Adder	24 1/4"	19 1/2"	96"	9 1/2"	12	14			\$ 4,353		
DM-9624-S-SL-24-SB	Double Face Starter	25 1/4"	23 1/2"	96"	11 1/2"	12	14			\$ 5,130		
DM-9624-A-SL-24-SB	Double Face Adder	24 1/4"	23 1/2"	96"	11 1/2"	12	14			\$ 4,463		
DM-9620-S-SL-30-SB	Double Face Starter	31 1/4"	19 1/2"	96"	9 1/2"	12	14			\$ 5,045		
DM-9620-A-SL-30-SB	Double Face Adder	30 1/4"	19 1/2"	96"	9 1/2"	12	14			\$ 4,353		
DM-9624-S-SL-30-SB	Double Face Starter	31 1/4"	23 1/2"	96"	11 1/2"	12	14			\$ 5,130		
DM-9624-A-SL-30-SB	Double Face Adder	30 1/4"	23 1/2"	96"	11 1/2"	12	14			\$ 4,463		
DM-9620-S-SL-36-SB	Double Face Starter	37 1/4"	19 1/2"	96"	9 1/2"	12	14	276 Lbs.	13 Cu Ft	\$ 4,751		
DM-9620-A-SL-36-SB	Double Face Adder	36 1/4"	19 1/2"	96"	9 1/2"	12	14	220 Lbs.	12 Cu Ft	\$ 4,073		
DM-9624-S-SL-36-SB	Double Face Starter	37 1/4"	23 1/2"	96"	11 1/2"	12	14	315 Lbs.	15 Cu Ft	\$ 4,844		
DM-9624-A-SL-36-SB	Double Face Adder	36 1/4"	23 1/2"	96"	11 1/2"	12	14	247 Lbs.	13 Cu Ft	\$ 4,168		

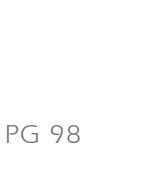
	MODEL NUMBER	PRODUCT	WIDTH	DEPTH	HEIGHT	SHELF DEPTH	# OF SHELVES	# OF OPENINGS	WEIGHT	VOLUME	LIST PRICE	DESCRIPTION
 Model Shown DM-3612-S-SL-36-IPT	DM-3610-S-SL-24-IPT	Single Face Starter	25 1/4"	10 1/8"	36"	9 1/2"	1	2			\$ 1,593	End, Mid, Top and Base Panels to be constructed from 1" thick 11-ply solid core, veneered 2 sides. Vertical, top and bottom edges banded with 1/4" external hardwood edging, edges to be eased. Front Edge: 3/4" thick x 2 1/2" high fascia - tongue and grooved to top.
	DM-3610-A-SL-24-IPT	Single Face Adder	24 1/4"	10 1/8"	36"	9 1/2"	1	2			\$ 1,220	
	DM-3612-S-SL-24-IPT	Single Face Starter	25 1/4"	12 1/8"	36"	11 1/2"	1	2			\$ 1,656	
	DM-3612-A-SL-24-IPT	Single Face Adder	24 1/4"	12 1/8"	36"	11 1/2"	1	2			\$ 1,251	
 Model Shown DM-3612-A-SL-36-IPT	DM-3610-S-SL-30-IPT	Single Face Starter	31 1/4"	10 1/8"	36"	9 1/2"	1	2			\$ 1,593	
	DM-3610-A-SL-30-IPT	Single Face Adder	30 1/4"	10 1/8"	36"	9 1/2"	1	2			\$ 1,220	
	DM-3612-S-SL-30-IPT	Single Face Starter	31 1/4"	12 1/8"	36"	11 1/2"	1	2			\$ 1,656	
	DM-3612-A-SL-30-IPT	Single Face Adder	30 1/4"	12 1/8"	36"	11 1/2"	1	2			\$ 1,251	
 Model Shown DM-3612-A-SL-36-IPT	DM-3610-S-SL-36-IPT	Single Face Starter	37 1/4"	10 1/8"	36"	9 1/2"	1	2	50.6 Lbs.	4 Cu Ft	\$ 1,406	
	DM-3610-A-SL-36-IPT	Single Face Adder	36 1/4"	10 1/8"	36"	9 1/2"	1	2	46 Lbs.	4 Cu Ft	\$ 1,019	
	DM-3612-S-SL-36-IPT	Single Face Starter	37 1/4"	12 1/8"	36"	11 1/2"	1	2	50.6 Lbs.	5 Cu Ft	\$ 1,462	
	DM-3612-A-SL-36-IPT	Single Face Adder	36 1/4"	12 1/8"	36"	11 1/2"	1	2	47.2 Lbs.	5 Cu Ft	\$ 1,065	
 Model Shown DM-4212-S-SL-36-IPT	DM-4210-S-SL-24-IPT	Single Face Starter	25 1/4"	10 1/8"	42"	9 1/2"	2	3			\$ 1,976	
	DM-4210-A-SL-24-IPT	Single Face Adder	24 1/4"	10 1/8"	42"	9 1/2"	2	3			\$ 1,593	
	DM-4212-S-SL-24-IPT	Single Face Starter	25 1/4"	12 1/8"	42"	11 1/2"	2	3			\$ 2,029	
	DM-4212-A-SL-24-IPT	Single Face Adder	24 1/4"	12 1/8"	42"	11 1/2"	2	3			\$ 1,641	
 Model Shown DM-4212-A-SL-36-IPT	DM-4210-S-SL-30-IPT	Single Face Starter	31 1/4"	10 1/8"	42"	9 1/2"	2	3			\$ 1,976	
	DM-4210-A-SL-30-IPT	Single Face Adder	30 1/4"	10 1/8"	42"	9 1/2"	2	3			\$ 1,593	
	DM-4212-S-SL-30-IPT	Single Face Starter	31 1/4"	12 1/8"	42"	11 1/2"	2	3			\$ 2,029	
	DM-4212-A-SL-30-IPT	Single Face Adder	30 1/4"	12 1/8"	42"	11 1/2"	2	3			\$ 1,641	
 Model Shown DM-4212-A-SL-36-IPT	DM-4210-S-SL-36-IPT	Single Face Starter	37 1/4"	10 1/8"	42"	9 1/2"	2	3	55 Lbs.	5 Cu Ft	\$ 1,780	
	DM-4210-A-SL-36-IPT	Single Face Adder	36 1/4"	10 1/8"	42"	9 1/2"	2	3	52 Lbs.	5 Cu Ft	\$ 1,369	
	DM-4212-S-SL-36-IPT	Single Face Starter	37 1/4"	12 1/8"	42"	11 1/2"	2	3	60 Lbs.	5 Cu Ft	\$ 1,841	
	DM-4212-A-SL-36-IPT	Single Face Adder	36 1/4"	12 1/8"	42"	11 1/2"	2	3	53 Lbs.	5 Cu Ft	\$ 1,447	
 Model Shown DM-4212-A-SL-36-IPT	DM-4810-S-SL-24-IPT	Single Face Starter	25 1/4"	10 1/8"	48"	9 1/2"	2	3			\$ 1,998	
	DM-4810-A-SL-24-IPT	Single Face Adder	24 1/4"	10 1/8"	48"	9 1/2"	2	3			\$ 1,610	
	DM-4812-S-SL-24-IPT	Single Face Starter	25 1/4"	12 1/8"	48"	11 1/2"	2	3			\$ 2,045	
	DM-4812-A-SL-24-IPT	Single Face Adder	24 1/4"	12 1/8"	48"	11 1/2"	2	3			\$ 1,641	
 Model Shown DM-4212-A-SL-36-IPT	DM-4810-S-SL-30-IPT	Single Face Starter	31 1/4"	10 1/8"	48"	9 1/2"	2	3			\$ 1,998	
	DM-4810-A-SL-30-IPT	Single Face Adder	30 1/4"	10 1/8"	48"	9 1/2"	2	3			\$ 1,610	
	DM-4812-S-SL-30-IPT	Single Face Starter	31 1/4"	12 1/8"	48"	11 1/2"	2	3			\$ 2,045	
	DM-4812-A-SL-30-IPT	Single Face Adder	30 1/4"	12 1/8"	48"	11 1/2"	2	3			\$ 1,641	
 Model Shown DM-4212-A-SL-36-IPT	DM-4810-S-SL-36-IPT	Single Face Starter	37 1/4"	10 1/8"	48"	9 1/2"	2	3	74.8 Lbs.	5 Cu Ft	\$ 1,811	
	DM-4810-A-SL-36-IPT	Single Face Adder	36 1/4"	10 1/8"	48"	9 1/2"	2	3	65.5 Lbs.	5 Cu Ft	\$ 1,393	
	DM-4812-S-SL-36-IPT	Single Face Starter	37 1/4"	12 1/8"	48"	11 1/2"	2	3	82.8 Lbs.	6 Cu Ft	\$ 1,858	
	DM-4812-A-SL-36-IPT	Single Face Adder	36 1/4"	12 1/8"	48"	11 1/2"	2	3	71.3 Lbs.	6 Cu Ft	\$ 1,447	











Model Shown  
DM-6012-S-SL-36-IPT





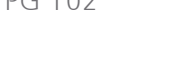



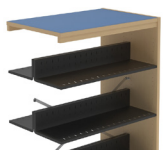



Model Shown  
DM-6012-A-SL-36-IPT





MODEL NUMBER	PRODUCT	WIDTH	DEPTH	HEIGHT	SHELF DEPTH	# OF SHELVES	# OF OPENINGS	WEIGHT	VOLUME	LIST PRICE	DESCRIPTION
DM-6010-S-SL-24-IPT	Single Face Starter	25 1/4"	10 1/8"	60"	9 1/2"	3	4			\$ 2,184	End, Mid, Top and Base Panels to be constructed from 1" thick 11-ply solid core, veneered 2 sides. Vertical, top and bottom edges banded with 1/4" external hardwood edging, edges to be eased. Front Edge: 3/4" thick x 2 1/2" high fascia - tongue and grooved to top.
DM-6010-A-SL-24-IPT	Single Face Adder	24 1/4"	10 1/8"	60"	9 1/2"	3	4			\$ 1,811	
DM-6012-S-SL-24-IPT	Single Face Starter	25 1/4"	12 1/8"	60"	11 1/2"	3	4			\$ 2,239	
DM-6012-A-SL-24-IPT	Single Face Adder	24 1/4"	12 1/8"	60"	11 1/2"	3	4			\$ 1,851	
DM-6010-S-SL-30-IPT	Single Face Starter	31 1/4"	10 1/8"	60"	9 1/2"	3	4			\$ 2,184	
DM-6010-A-SL-30-IPT	Single Face Adder	30 1/4"	10 1/8"	60"	9 1/2"	3	4			\$ 1,811	
DM-6012-S-SL-30-IPT	Single Face Starter	31 1/4"	12 1/8"	60"	11 1/2"	3	4			\$ 2,239	
DM-6012-A-SL-30-IPT	Single Face Adder	30 1/4"	12 1/8"	60"	11 1/2"	3	4			\$ 1,851	
DM-6010-S-SL-36-IPT	Single Face Starter	37 1/4"	10 1/8"	60"	9 1/2"	3	4	100 Lbs.	6 Cu Ft	\$ 1,998	
DM-6010-A-SL-36-IPT	Single Face Adder	36 1/4"	10 1/8"	60"	9 1/2"	3	4	86.3 Lbs.	6 Cu Ft	\$ 1,610	
DM-6012-S-SL-36-IPT	Single Face Starter	37 1/4"	12 1/8"	60"	11 1/2"	3	4	116 Lbs.	8 Cu Ft	\$ 2,045	
DM-6012-A-SL-36-IPT	Single Face Adder	36 1/4"	12 1/8"	60"	11 1/2"	3	4	95.5 Lbs.	7 Cu Ft	\$ 1,656	

	MODEL NUMBER	PRODUCT	WIDTH	DEPTH	HEIGHT	SHELF DEPTH	# OF SHELVES	# OF OPENINGS	WEIGHT	VOLUME	LIST PRICE	DESCRIPTION
 <p>Model Shown DM-3624-S-SL-36-IPT</p>	DM-3620-S-SL-24-SB-IPT	Double Face Starter	25 1/4"	19 1/2"	36"	9 1/2"	2	4			\$ 2,899	End, Mid, Top and Base Panels to be constructed from 1" thick 11-ply solid core, veneered 2 sides. Vertical, top and bottom edges banded with 1/4" external hardwood edging, edges to be eased. Front Edge: 3/4" thick x 2 1/2" high fascia - tongue and grooved to top.
	DM-3620-A-SL-24-SB-IPT	Double Face Adder	24 1/4"	19 1/2"	36"	9 1/2"	2	4			\$ 2,246	
	DM-3624-S-SL-24-SB-IPT	Double Face Starter	25 1/4"	23 1/2"	36"	11 1/2"	2	4			\$ 2,939	
	DM-3624-A-SL-24-SB-IPT	Double Face Adder	24 1/4"	23 1/2"	36"	11 1/2"	2	4			\$ 2,263	
 <p>Model Shown DM-3624-S-SL-36-IPT</p>	DM-3620-S-SL-30-SB-IPT	Double Face Starter	31 1/4"	19 1/2"	36"	9 1/2"	2	4			\$ 2,899	
	DM-3620-A-SL-30-SB-IPT	Double Face Adder	30 1/4"	19 1/2"	36"	9 1/2"	2	4			\$ 2,246	
	DM-3624-S-SL-30-SB-IPT	Double Face Starter	31 1/4"	23 1/2"	36"	11 1/2"	2	4			\$ 2,939	
	DM-3624-A-SL-30-SB-IPT	Double Face Adder	30 1/4"	23 1/2"	36"	11 1/2"	2	4			\$ 2,263	
 <p>Model Shown DM-3624-A-SL-36-IPT</p>	DM-3620-S-SL-36-SB-IPT	Double Face Starter	37 1/4"	19 1/2"	36"	9 1/2"	2	4	88.6 Lbs.	7 Cu Ft	\$ 2,605	
	DM-3620-A-SL-36-SB-IPT	Double Face Adder	36 1/4"	19 1/2"	36"	9 1/2"	2	4	73.6 Lbs.	6 Cu Ft	\$ 1,952	
	DM-3624-S-SL-36-SB-IPT	Double Face Starter	37 1/4"	23 1/2"	36"	11 1/2"	2	4	110 Lbs.	10 Cu Ft	\$ 2,659	
	DM-3624-A-SL-36-SB-IPT	Double Face Adder	36 1/4"	23 1/2"	36"	11 1/2"	2	4	88.6 Lbs.	9 Cu Ft	\$ 1,976	
 <p>Model Shown DM-4224-S-SL-36-IPT</p>	DM-4220-S-SL-24-SB-IPT	Double Face Starter	25 1/4"	19 1/2"	42"	9 1/2"	4	6			\$ 3,358	
	DM-4220-A-SL-24-SB-IPT	Double Face Adder	24 1/4"	19 1/2"	42"	9 1/2"	4	6			\$ 2,690	
	DM-4224-S-SL-24-SB-IPT	Double Face Starter	25 1/4"	23 1/2"	42"	11 1/2"	4	6			\$ 3,412	
	DM-4224-A-SL-24-SB-IPT	Double Face Adder	24 1/4"	23 1/2"	42"	11 1/2"	4	6			\$ 2,705	
 <p>Model Shown DM-4224-S-SL-36-IPT</p>	DM-4220-S-SL-30-SB-IPT	Double Face Starter	31 1/4"	19 1/2"	42"	9 1/2"	4	6			\$ 3,358	
	DM-4220-A-SL-30-SB-IPT	Double Face Adder	30 1/4"	19 1/2"	42"	9 1/2"	4	6			\$ 2,690	
	DM-4224-S-SL-30-SB-IPT	Double Face Starter	31 1/4"	23 1/2"	42"	11 1/2"	4	6			\$ 3,412	
	DM-4224-A-SL-30-SB-IPT	Double Face Adder	30 1/4"	23 1/2"	42"	11 1/2"	4	6			\$ 2,705	
 <p>Model Shown DM-4224-A-SL-36-IPT</p>	DM-4220-S-SL-36-SB-IPT	Double Face Starter	37 1/4"	19 1/2"	42"	9 1/2"	4	6	94 Lbs.	7 Cu Ft	\$ 3,070	
	DM-4220-A-SL-36-SB-IPT	Double Face Adder	36 1/4"	19 1/2"	42"	9 1/2"	4	6	78 Lbs.	7 Cu Ft	\$ 2,401	
	DM-4224-S-SL-36-SB-IPT	Double Face Starter	37 1/4"	23 1/2"	42"	11 1/2"	4	6	115 Lbs.	10 Cu Ft	\$ 3,116	
	DM-4224-A-SL-36-SB-IPT	Double Face Adder	36 1/4"	23 1/2"	42"	11 1/2"	4	6	113 Lbs.	10 Cu Ft	\$ 2,417	
 <p>Model Shown DM-4824-S-SL-36-IPT</p>	DM-4820-S-SL-24-SB-IPT	Double Face Starter	25 1/4"	19 1/2"	48"	9 1/2"	4	6			\$ 3,444	
	DM-4820-A-SL-24-SB-IPT	Double Face Adder	24 1/4"	19 1/2"	48"	9 1/2"	4	6			\$ 2,961	
	DM-4824-S-SL-24-SB-IPT	Double Face Starter	25 1/4"	23 1/2"	48"	11 1/2"	4	6			\$ 3,686	
	DM-4824-A-SL-24-SB-IPT	Double Face Adder	24 1/4"	23 1/2"	48"	11 1/2"	4	6			\$ 2,992	
 <p>Model Shown DM-4824-S-SL-36-IPT</p>	DM-4820-S-SL-30-SB-IPT	Double Face Starter	31 1/4"	19 1/2"	48"	9 1/2"	4	6			\$ 3,444	
	DM-4820-A-SL-30-SB-IPT	Double Face Adder	30 1/4"	19 1/2"	48"	9 1/2"	4	6			\$ 2,961	
	DM-4824-S-SL-30-SB-IPT	Double Face Starter	31 1/4"	23 1/2"	48"	11 1/2"	4	6			\$ 3,686	
	DM-4824-A-SL-30-SB-IPT	Double Face Adder	30 1/4"	23 1/2"	48"	11 1/2"	4	6			\$ 2,992	
<p>Model Shown DM-4824-S-SL-36-IPT</p>	DM-4820-S-SL-36-SB-IPT	Double Face Starter	37 1/4"	19 1/2"	48"	9 1/2"	4	6	132 Lbs.	9 Cu Ft	\$ 3,334	
	DM-4820-A-SL-36-SB-IPT	Double Face Adder	36 1/4"	19 1/2"	48"	9 1/2"	4	6	109 Lbs.	8 Cu Ft	\$ 2,682	
	DM-4824-S-SL-36-SB-IPT	Double Face Starter	37 1/4"	23 1/2"	48"	11 1/2"	4	6	155 Lbs.	11 Cu Ft	\$ 3,397	
	DM-4824-A-SL-36-SB-IPT	Double Face Adder	36 1/4"	23 1/2"	48"	11 1/2"	4	6	127 Lbs.	10 Cu Ft	\$ 2,712	





MODEL NUMBER	PRODUCT	WIDTH	DEPTH	HEIGHT	SHELF DEPTH	# OF SHELVES	# OF OPENINGS	WEIGHT	VOLUME	LIST PRICE	DESCRIPTION
 Model Shown DM-6024-S-SL-36-IPT	DM-6020-S-SL-24-SB-IPT	Double Face Starter	25 1/4"	19 1/2"	60"	9 1/2"	6			\$ 4,042	End, Mid, Top and Base Panels to be constructed from 1" thick 11-ply solid core, veneered 2 sides. Vertical, top and bottom edges banded with 1/4" external hardwood edging, edges to be eased. Front Edge: 3/4" thick x 2 1/2" high fascia - tongue and grooved to top.
	DM-6020-A-SL-24-SB-IPT	Double Face Adder	24 1/4"	19 1/2"	60"	9 1/2"	6			\$ 3,358	
	DM-6024-S-SL-24-SB-IPT	Double Face Starter	25 1/4"	23 1/2"	60"	11 1/2"	6			\$ 4,097	
	DM-6024-A-SL-24-SB-IPT	Double Face Adder	24 1/4"	23 1/2"	60"	11 1/2"	6			\$ 3,428	
 Model Shown DM-6024-A-SL-36-IPT	DM-6020-S-SL-30-SB-IPT	Double Face Starter	31 1/4"	19 1/2"	60"	9 1/2"	6			\$ 4,042	
	DM-6020-A-SL-30-SB-IPT	Double Face Adder	30 1/4"	19 1/2"	60"	9 1/2"	6			\$ 3,358	
	DM-6024-S-SL-30-SB-IPT	Double Face Starter	31 1/4"	23 1/2"	60"	11 1/2"	6			\$ 4,097	
	DM-6024-A-SL-30-SB-IPT	Double Face Adder	30 1/4"	23 1/2"	60"	11 1/2"	6			\$ 3,428	
	DM-6020-S-SL-36-SB-IPT	Double Face Starter	37 1/4"	19 1/2"	60"	9 1/2"	6	176 Lbs.	11 Cu Ft	\$ 3,756	
	DM-6020-A-SL-36-SB-IPT	Double Face Adder	36 1/4"	19 1/2"	60"	9 1/2"	6	145 Lbs.	10 Cu Ft	\$ 3,070	
	DM-6024-S-SL-36-SB-IPT	Double Face Starter	37 1/4"	23 1/2"	60"	11 1/2"	6	200 Lbs.	12 Cu Ft	\$ 3,801	
	DM-6024-A-SL-36-SB-IPT	Double Face Adder	36 1/4"	23 1/2"	60"	11 1/2"	6	164 Lbs.	11 Cu Ft	\$ 3,134	

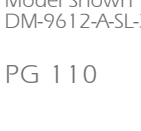



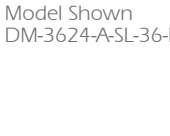

	MODEL NUMBER	PRODUCT	WIDTH	DEPTH	HEIGHT	SHELF DEPTH	# OF SHELVES	# OF OPENINGS	WEIGHT	VOLUME	LIST PRICE	DESCRIPTION
 Model Shown DM-3612-S-SL-36-PB	DM-3610-S-SL-24-PB	Single Face Starter	25 1/4"	10 1/8"	36"	9 1/2"	1	2			\$ 1,610	End, Mid, Top and Base Panels to be constructed from 1" thick 11-ply solid core, veneered 2 sides. Vertical, top and bottom edges banded with 1/4" external hardwood edging, edges to be eased. Front Edge: 3/4" thick x 2 1/2" high fascia - tongue and grooved to top.
	DM-3610-A-SL-24-PB	Single Face Adder	24 1/4"	10 1/8"	36"	9 1/2"	1	2			\$ 1,220	
	DM-3612-S-SL-24-PB	Single Face Starter	25 1/4"	12 1/8"	36"	11 1/2"	1	2			\$ 1,664	
	DM-3612-A-SL-24-PB	Single Face Adder	24 1/4"	12 1/8"	36"	11 1/2"	1	2			\$ 1,268	
 Model Shown DM-3612-A-SL-36-PB	DM-3610-S-SL-30-PB	Single Face Starter	31 1/4"	10 1/8"	36"	9 1/2"	1	2			\$ 1,571	
	DM-3610-A-SL-30-PB	Single Face Adder	30 1/4"	10 1/8"	36"	9 1/2"	1	2			\$ 1,220	
	DM-3612-S-SL-30-PB	Single Face Starter	31 1/4"	12 1/8"	36"	11 1/2"	1	2			\$ 1,664	
	DM-3612-A-SL-30-PB	Single Face Adder	30 1/4"	12 1/8"	36"	11 1/2"	1	2			\$ 1,268	
 Model Shown DM-3612-A-SL-36-PB	DM-3610-S-SL-36-PB	Single Face Starter	37 1/4"	10 1/8"	36"	9 1/2"	1	2	50.6 Lbs.	4 Cu Ft	\$ 1,406	
	DM-3610-A-SL-36-PB	Single Face Adder	36 1/4"	10 1/8"	36"	9 1/2"	1	2	46 Lbs.	4 Cu Ft	\$ 1,042	
	DM-3612-S-SL-36-PB	Single Face Starter	37 1/4"	12 1/8"	36"	11 1/2"	1	2	50.6 Lbs.	5 Cu Ft	\$ 1,478	
	DM-3612-A-SL-36-PB	Single Face Adder	36 1/4"	12 1/8"	36"	11 1/2"	1	2	47.2 Lbs.	5 Cu Ft	\$ 1,073	
 Model Shown DM-4212-S-SL-36-PB	DM-4210-S-SL-24-PB	Single Face Starter	25 1/4"	10 1/8"	42"	9 1/2"	2	3			\$ 1,983	
	DM-4210-A-SL-24-PB	Single Face Adder	24 1/4"	10 1/8"	42"	9 1/2"	2	3			\$ 1,610	
	DM-4212-S-SL-24-PB	Single Face Starter	25 1/4"	12 1/8"	42"	11 1/2"	2	3			\$ 2,045	
	DM-4212-A-SL-24-PB	Single Face Adder	24 1/4"	12 1/8"	42"	11 1/2"	2	3			\$ 1,648	
 Model Shown DM-4212-A-SL-36-PB	DM-4210-S-SL-30-PB	Single Face Starter	31 1/4"	10 1/8"	42"	9 1/2"	2	3			\$ 1,983	
	DM-4210-A-SL-30-PB	Single Face Adder	30 1/4"	10 1/8"	42"	9 1/2"	2	3			\$ 1,610	
	DM-4212-S-SL-30-PB	Single Face Starter	31 1/4"	12 1/8"	42"	11 1/2"	2	3			\$ 2,045	
	DM-4212-A-SL-30-PB	Single Face Adder	30 1/4"	12 1/8"	42"	11 1/2"	2	3			\$ 1,648	
 Model Shown DM-4212-A-SL-36-PB	DM-4210-S-SL-36-PB	Single Face Starter	37 1/4"	10 1/8"	42"	9 1/2"	2	3	55 Lbs.	5 Cu Ft	\$ 1,795	
	DM-4210-A-SL-36-PB	Single Face Adder	36 1/4"	10 1/8"	42"	9 1/2"	2	3	52 Lbs.	5 Cu Ft	\$ 1,393	
	DM-4212-S-SL-36-PB	Single Face Starter	37 1/4"	12 1/8"	42"	11 1/2"	2	3	60 Lbs.	5 Cu Ft	\$ 1,851	
	DM-4212-A-SL-36-PB	Single Face Adder	36 1/4"	12 1/8"	42"	11 1/2"	2	3	53 Lbs.	5 Cu Ft	\$ 1,462	
	DM-4810-S-SL-24-PB	Single Face Starter	25 1/4"	10 1/8"	48"	9 1/2"	2	3			\$ 2,014	
	DM-4810-A-SL-24-PB	Single Face Adder	24 1/4"	10 1/8"	48"	9 1/2"	2	3			\$ 1,610	
	DM-4812-S-SL-24-PB	Single Face Starter	25 1/4"	12 1/8"	48"	11 1/2"	2	3			\$ 2,060	
	DM-4812-A-SL-24-PB	Single Face Adder	24 1/4"	12 1/8"	48"	11 1/2"	2	3			\$ 1,648	
	DM-4810-S-SL-30-PB	Single Face Starter	31 1/4"	10 1/8"	48"	9 1/2"	2	3			\$ 2,014	
	DM-4810-A-SL-30-PB	Single Face Adder	30 1/4"	10 1/8"	48"	9 1/2"	2	3			\$ 1,610	
	DM-4812-S-SL-30-PB	Single Face Starter	31 1/4"	12 1/8"	48"	11 1/2"	2	3			\$ 2,060	
	DM-4812-A-SL-30-PB	Single Face Adder	30 1/4"	12 1/8"	48"	11 1/2"	2	3			\$ 1,648	
	DM-4810-S-SL-36-PB	Single Face Starter	37 1/4"	10 1/8"	48"	9 1/2"	2	3	74.8 Lbs.	5 Cu Ft	\$ 1,827	
	DM-4810-A-SL-36-PB	Single Face Adder	36 1/4"	10 1/8"	48"	9 1/2"	2	3	65.5 Lbs.	5 Cu Ft	\$ 1,431	
	DM-4812-S-SL-36-PB	Single Face Starter	37 1/4"	12 1/8"	48"	11 1/2"	2	3	82.8 Lbs.	6 Cu Ft	\$ 1,865	
	DM-4812-A-SL-36-PB	Single Face Adder	36 1/4"	12 1/8"	48"	11 1/2"	2	3	71.3 Lbs.	6 Cu Ft	\$ 1,462	

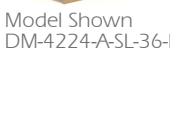

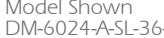

	MODEL NUMBER	PRODUCT	WIDTH	DEPTH	HEIGHT	SHELF DEPTH	# OF SHELVES	# OF OPENINGS	WEIGHT	VOLUME	LIST PRICE	DESCRIPTION
 <p>Model Shown DM-6012-S-SL-36-PB</p>	DM-6010-S-SL-24-PB	Single Face Starter	25 1/4"	10 1/8"	60"	9 1/2"	3	4			\$ 2,309	End, Mid, Top and Base Panels to be constructed from 1" thick 11-ply solid core, veneered 2 sides. Vertical, top and bottom edges banded with 1/4" external hardwood edging, edges to be eased. Front Edge: 3/4" thick x 2 1/2" high fascia - tongue and grooved to top.
	DM-6010-A-SL-24-PB	Single Face Adder	24 1/4"	10 1/8"	60"	9 1/2"	3	4			\$ 1,929	
	DM-6012-S-SL-24-PB	Single Face Starter	25 1/4"	12 1/8"	60"	11 1/2"	3	4			\$ 2,356	
	DM-6012-A-SL-24-PB	Single Face Adder	24 1/4"	12 1/8"	60"	11 1/2"	3	4			\$ 1,965	
	DM-6010-S-SL-30-PB	Single Face Starter	31 1/4"	10 1/8"	60"	9 1/2"	3	4			\$ 2,309	
	DM-6010-A-SL-30-PB	Single Face Adder	30 1/4"	10 1/8"	60"	9 1/2"	3	4			\$ 1,929	
	DM-6012-S-SL-30-PB	Single Face Starter	31 1/4"	12 1/8"	60"	11 1/2"	3	4			\$ 2,356	
	DM-6012-A-SL-30-PB	Single Face Adder	30 1/4"	12 1/8"	60"	11 1/2"	3	4			\$ 1,965	
 <p>Model Shown DM-6012-A-SL-36-PB</p>	DM-6010-S-SL-36-PB	Single Face Starter	37 1/4"	10 1/8"	60"	9 1/2"	3	4	100 Lbs.	6 Cu Ft	\$ 2,115	
	DM-6010-A-SL-36-PB	Single Face Adder	36 1/4"	10 1/8"	60"	9 1/2"	3	4	86.3 Lbs.	6 Cu Ft	\$ 1,741	
	DM-6012-S-SL-36-PB	Single Face Starter	37 1/4"	12 1/8"	60"	11 1/2"	3	4	116 Lbs.	8 Cu Ft	\$ 2,162	
	DM-6012-A-SL-36-PB	Single Face Adder	36 1/4"	12 1/8"	60"	11 1/2"	3	4	95.5 Lbs.	7 Cu Ft	\$ 1,772	
 <p>Model Shown DM-7212-S-SL-36-PB</p>	DM-7210-S-SL-24-PB	Single Face Starter	25 1/4"	10 1/8"	72"	9 1/2"	4	5			\$ 2,558	
	DM-7210-A-SL-24-PB	Single Face Adder	24 1/4"	10 1/8"	72"	9 1/2"	4	5			\$ 2,177	
	DM-7212-S-SL-24-PB	Single Face Starter	25 1/4"	12 1/8"	72"	11 1/2"	4	5			\$ 2,619	
	DM-7212-A-SL-24-PB	Single Face Adder	24 1/4"	12 1/8"	72"	11 1/2"	4	5			\$ 2,231	
	DM-7210-S-SL-30-PB	Single Face Starter	31 1/4"	10 1/8"	72"	9 1/2"	4	5			\$ 2,558	
	DM-7210-A-SL-30-PB	Single Face Adder	30 1/4"	10 1/8"	72"	9 1/2"	4	5			\$ 2,177	
	DM-7212-S-SL-30-PB	Single Face Starter	31 1/4"	12 1/8"	72"	11 1/2"	4	5			\$ 2,619	
	DM-7212-A-SL-30-PB	Single Face Adder	30 1/4"	12 1/8"	72"	11 1/2"	4	5			\$ 2,231	
	DM-7210-S-SL-36-PB	Single Face Starter	37 1/4"	10 1/8"	72"	9 1/2"	4	5	115 Lbs.	7 Cu Ft	\$ 2,370	
	DM-7210-A-SL-36-PB	Single Face Adder	36 1/4"	10 1/8"	72"	9 1/2"	4	5	96.6 Lbs.	7 Cu Ft	\$ 1,983	
	DM-7212-S-SL-36-PB	Single Face Starter	37 1/4"	12 1/8"	72"	11 1/2"	4	5	131 Lbs.	8 Cu Ft	\$ 2,441	
	DM-7212-A-SL-36-PB	Single Face Adder	36 1/4"	12 1/8"	72"	11 1/2"	4	5	109 Lbs.	8 Cu Ft	\$ 2,045	
 <p>Model Shown DM-7212-A-SL-36-PB</p>												

MODEL NUMBER	PRODUCT	WIDTH	DEPTH	HEIGHT	SHELF DEPTH	# OF SHELVES	# OF OPENINGS	WEIGHT	VOLUME	LIST PRICE	DESCRIPTION
 Model Shown DM-8212-S-SL-36-PB	DM-8210-S-SL-24-PB	Single Face Starter	25 1/4"	10 1/8"	82"	9 1/2"	5			\$ 2,806	End, Mid, Top and Base Panels to be constructed from 1" thick 11-ply solid core, veneered 2 sides. Vertical, top and bottom edges banded with 1/4" external hardwood edging, edges to be eased. Front Edge: 3/4" thick x 2 1/2" high fascia - tongue and grooved to top.
	DM-8210-A-SL-24-PB	Single Face Adder	24 1/4"	10 1/8"	82"	9 1/2"	5			\$ 2,441	
	DM-8212-S-SL-24-PB	Single Face Starter	25 1/4"	12 1/8"	82"	11 1/2"	5			\$ 2,884	
	DM-8212-A-SL-24-PB	Single Face Adder	24 1/4"	12 1/8"	82"	11 1/2"	5			\$ 2,487	
 Model Shown DM-8212-A-SL-36-PB	DM-8210-S-SL-30-PB	Single Face Starter	31 1/4"	10 1/8"	82"	9 1/2"	5			\$ 2,806	
	DM-8210-A-SL-30-PB	Single Face Adder	30 1/4"	10 1/8"	82"	9 1/2"	5			\$ 2,441	
	DM-8212-S-SL-30-PB	Single Face Starter	31 1/4"	12 1/8"	82"	11 1/2"	5			\$ 2,884	
	DM-8212-A-SL-30-PB	Single Face Adder	30 1/4"	12 1/8"	82"	11 1/2"	5			\$ 2,487	
 Model Shown DM-9612-S-SL-36-PB	DM-8210-S-SL-36-PB	Single Face Starter	37 1/4"	10 1/8"	82"	9 1/2"	5			\$ 2,619	
	DM-8210-A-SL-36-PB	Single Face Adder	36 1/4"	10 1/8"	82"	9 1/2"	5			\$ 2,246	
	DM-8212-S-SL-36-PB	Single Face Starter	37 1/4"	12 1/8"	82"	11 1/2"	5			\$ 2,698	
	DM-8212-A-SL-36-PB	Single Face Adder	36 1/4"	12 1/8"	82"	11 1/2"	5			\$ 2,301	
 Model Shown DM-9612-S-SL-36-PB	DM-9610-S-SL-24-PB	Single Face Starter	25 1/4"	10 1/8"	96"	9 1/2"	6			\$ 3,070	
	DM-9610-A-SL-24-PB	Single Face Adder	24 1/4"	10 1/8"	96"	9 1/2"	6			\$ 2,682	
	DM-9612-S-SL-24-PB	Single Face Starter	25 1/4"	12 1/8"	96"	11 1/2"	6			\$ 3,148	
	DM-9612-A-SL-24-PB	Single Face Adder	24 1/4"	12 1/8"	96"	11 1/2"	6			\$ 2,783	
 Model Shown DM-9612-A-SL-36-PB	DM-9610-S-SL-30-PB	Single Face Starter	31 1/4"	10 1/8"	96"	9 1/2"	6			\$ 3,070	
	DM-9610-A-SL-30-PB	Single Face Adder	30 1/4"	10 1/8"	96"	9 1/2"	6			\$ 2,682	
	DM-9612-S-SL-30-PB	Single Face Starter	31 1/4"	12 1/8"	96"	11 1/2"	6			\$ 3,148	
	DM-9612-A-SL-30-PB	Single Face Adder	30 1/4"	12 1/8"	96"	11 1/2"	6			\$ 2,783	
 Model Shown DM-9612-A-SL-36-PB	DM-9610-S-SL-36-PB	Single Face Starter	37 1/4"	10 1/8"	96"	9 1/2"	6			\$ 2,876	
	DM-9610-A-SL-36-PB	Single Face Adder	36 1/4"	10 1/8"	96"	9 1/2"	6			\$ 2,487	
	DM-9612-S-SL-36-PB	Single Face Starter	37 1/4"	12 1/8"	96"	11 1/2"	6			\$ 2,953	
	DM-9612-A-SL-36-PB	Single Face Adder	36 1/4"	12 1/8"	96"	11 1/2"	6			\$ 2,588	



	MODEL NUMBER	PRODUCT	WIDTH	DEPTH	HEIGHT	SHELF DEPTH	# OF SHELVES	# OF OPENINGS	WEIGHT	VOLUME	LIST PRICE	DESCRIPTION
 <p>Model Shown DM3624-S-SL-36-PB</p>	DM-3620-S-SL-24-PB	Double Face Starter	25 1/4"	19 1/2"	36"	9 1/2"	2	4			\$ 2,846	End, Mid, Top and Base Panels to be constructed from 1" thick 11-ply solid core, veneered 2 sides. Vertical, top and bottom edges banded with 1/4" external hardwood edging, edges to be eased. Front Edge: 3/4" thick x 2 1/2" high fascia - tongue and grooved to top.
	DM-3620-A-SL-24-PB	Double Face Adder	24 1/4"	19 1/2"	36"	9 1/2"	2	4			\$ 2,184	
	DM-3624-S-SL-24-PB	Double Face Starter	25 1/4"	23 1/2"	36"	11 1/2"	2	4			\$ 2,892	
	DM-3624-A-SL-24-PB	Double Face Adder	24 1/4"	23 1/2"	36"	11 1/2"	2	4			\$ 2,200	
 <p>Model Shown DM-3624-A-SL-36-PB</p>	DM-3620-S-SL-30-PB	Double Face Starter	31 1/4"	19 1/2"	36"	9 1/2"	2	4			\$ 2,846	
	DM-3620-A-SL-30-PB	Double Face Adder	30 1/4"	19 1/2"	36"	9 1/2"	2	4			\$ 2,184	
	DM-3624-S-SL-30-PB	Double Face Starter	31 1/4"	23 1/2"	36"	11 1/2"	2	4			\$ 2,892	
	DM-3624-A-SL-30-PB	Double Face Adder	30 1/4"	23 1/2"	36"	11 1/2"	2	4			\$ 2,200	
 <p>Model Shown DM-3624-A-SL-36-PB</p>	DM-3620-S-SL-36-PB	Double Face Starter	37 1/4"	19 1/2"	36"	9 1/2"	2	4	88.6 Lbs.	7 Cu Ft	\$ 2,551	
	DM-3620-A-SL-36-PB	Double Face Adder	36 1/4"	19 1/2"	36"	9 1/2"	2	4	73.6 Lbs.	6 Cu Ft	\$ 1,897	
	DM-3624-S-SL-36-PB	Double Face Starter	37 1/4"	23 1/2"	36"	11 1/2"	2	4	110 Lbs.	10 Cu Ft	\$ 2,605	
	DM-3624-A-SL-36-PB	Double Face Adder	36 1/4"	23 1/2"	36"	11 1/2"	2	4	88.6 Lbs.	9 Cu Ft	\$ 1,920	
 <p>Model Shown DM-4224-S-SL-36-PB</p>	DM-4220-S-SL-24-PB	Double Face Starter	25 1/4"	19 1/2"	42"	9 1/2"	4	6			\$ 3,304	
	DM-4220-A-SL-24-PB	Double Face Adder	24 1/4"	19 1/2"	42"	9 1/2"	4	6			\$ 2,636	
	DM-4224-S-SL-24-PB	Double Face Starter	25 1/4"	23 1/2"	42"	11 1/2"	4	6			\$ 3,351	
	DM-4224-A-SL-24-PB	Double Face Adder	24 1/4"	23 1/2"	42"	11 1/2"	4	6			\$ 2,659	
 <p>Model Shown DM-4224-S-SL-36-PB</p>	DM-4220-S-SL-30-PB	Double Face Starter	31 1/4"	19 1/2"	42"	9 1/2"	4	6			\$ 3,304	
	DM-4220-A-SL-30-PB	Double Face Adder	30 1/4"	19 1/2"	42"	9 1/2"	4	6			\$ 2,636	
	DM-4224-S-SL-30-PB	Double Face Starter	31 1/4"	23 1/2"	42"	11 1/2"	4	6			\$ 3,351	
	DM-4224-A-SL-30-PB	Double Face Adder	30 1/4"	23 1/2"	42"	11 1/2"	4	6			\$ 2,659	
 <p>Model Shown DM-4224-A-SL-36-PB</p>	DM-4220-S-SL-36-PB	Double Face Starter	37 1/4"	19 1/2"	42"	9 1/2"	4	6	94 Lbs.	7 Cu Ft	\$ 3,023	
	DM-4220-A-SL-36-PB	Double Face Adder	36 1/4"	19 1/2"	42"	9 1/2"	4	6	78 Lbs.	7 Cu Ft	\$ 2,339	
	DM-4224-S-SL-36-PB	Double Face Starter	37 1/4"	23 1/2"	42"	11 1/2"	4	6	115 Lbs.	10 Cu Ft	\$ 3,064	
	DM-4224-A-SL-36-PB	Double Face Adder	36 1/4"	23 1/2"	42"	11 1/2"	4	6	113 Lbs.	10 Cu Ft	\$ 2,363	
	DM-4820-S-SL-24-PB	Double Face Starter	25 1/4"	19 1/2"	48"	9 1/2"	4	6			\$ 3,397	
	DM-4820-A-SL-24-PB	Double Face Adder	24 1/4"	19 1/2"	48"	9 1/2"	4	6			\$ 2,915	
	DM-4824-S-SL-24-PB	Double Face Starter	25 1/4"	23 1/2"	48"	11 1/2"	4	6			\$ 3,631	
	DM-4824-A-SL-24-PB	Double Face Adder	24 1/4"	23 1/2"	48"	11 1/2"	4	6			\$ 2,946	
	DM-4820-S-SL-30-PB	Double Face Starter	31 1/4"	19 1/2"	48"	9 1/2"	4	6			\$ 3,397	
	DM-4820-A-SL-30-PB	Double Face Adder	30 1/4"	19 1/2"	48"	9 1/2"	4	6			\$ 2,915	
	DM-4824-S-SL-30-PB	Double Face Starter	31 1/4"	23 1/2"	48"	11 1/2"	4	6			\$ 3,631	
	DM-4824-A-SL-30-PB	Double Face Adder	30 1/4"	23 1/2"	48"	11 1/2"	4	6			\$ 2,946	
	DM-4820-S-SL-36-PB	Double Face Starter	37 1/4"	19 1/2"	48"	9 1/2"	4	6	132 Lbs.	9 Cu Ft	\$ 3,281	
	DM-4820-A-SL-36-PB	Double Face Adder	36 1/4"	19 1/2"	48"	9 1/2"	4	6	109 Lbs.	8 Cu Ft	\$ 2,619	
	DM-4824-S-SL-36-PB	Double Face Starter	37 1/4"	23 1/2"	48"	11 1/2"	4	6	155 Lbs.	11 Cu Ft	\$ 3,334	
	DM-4824-A-SL-36-PB	Double Face Adder	36 1/4"	23 1/2"	48"	11 1/2"	4	6	127 Lbs.	10 Cu Ft	\$ 2,659	

MODEL NUMBER	PRODUCT	WIDTH	DEPTH	HEIGHT	SHELF DEPTH	# OF SHELVES	# OF OPENINGS	WEIGHT	VOLUME	LIST PRICE	DESCRIPTION
	DM-6020-S-SL-24-PB	Double Face Starter	25 1/4"	19 1/2"	60"	9 1/2"	6			\$ 4,120	End, Mid, Top and Base Panels to be constructed from 1" thick 11-ply solid core, veneered 2 sides. Vertical, top and bottom edges banded with 1/4" external hardwood edging, edges to be eased. Front Edge: 3/4" thick x 2 1/2" high fascia - tongue and grooved to top.
	DM-6020-A-SL-24-PB	Double Face Adder	24 1/4"	19 1/2"	60"	9 1/2"	6			\$ 3,428	
	DM-6024-S-SL-24-PB	Double Face Starter	25 1/4"	23 1/2"	60"	11 1/2"	6			\$ 4,158	
	DM-6024-A-SL-24-PB	Double Face Adder	24 1/4"	23 1/2"	60"	11 1/2"	6			\$ 3,490	
	DM-6020-S-SL-30-PB	Double Face Starter	31 1/4"	19 1/2"	60"	9 1/2"	6			\$ 4,120	
	DM-6020-A-SL-30-PB	Double Face Adder	30 1/4"	19 1/2"	60"	9 1/2"	6			\$ 3,428	
	DM-6024-S-SL-30-PB	Double Face Starter	31 1/4"	23 1/2"	60"	11 1/2"	6			\$ 4,158	
	DM-6024-A-SL-30-PB	Double Face Adder	30 1/4"	23 1/2"	60"	11 1/2"	6			\$ 3,490	
	DM-6020-S-SL-36-PB	Double Face Starter	37 1/4"	19 1/2"	60"	9 1/2"	6			\$ 3,817	
	DM-6020-A-SL-36-PB	Double Face Adder	36 1/4"	19 1/2"	60"	9 1/2"	6	176 Lbs.	11 Cu Ft	\$ 3,141	
	DM-6024-S-SL-36-PB	Double Face Starter	37 1/4"	23 1/2"	60"	11 1/2"	6	200 Lbs.	12 Cu Ft	\$ 3,880	
	DM-6024-A-SL-36-PB	Double Face Adder	36 1/4"	23 1/2"	60"	11 1/2"	6	164 Lbs.	11 Cu Ft	\$ 3,210	
	DM-7220-S-SL-24-PB	Double Face Starter	25 1/4"	19 1/2"	72"	9 1/2"	8			\$ 4,626	
	DM-7220-A-SL-24-PB	Double Face Adder	24 1/4"	19 1/2"	72"	9 1/2"	8			\$ 3,934	
	DM-7224-S-SL-24-PB	Double Face Starter	25 1/4"	23 1/2"	72"	11 1/2"	8			\$ 4,687	
	DM-7224-A-SL-24-PB	Double Face Adder	24 1/4"	23 1/2"	72"	11 1/2"	8			\$ 4,004	
	DM-7220-S-SL-30-PB	Double Face Starter	31 1/4"	19 1/2"	72"	9 1/2"	8			\$ 4,626	
	DM-7220-A-SL-30-PB	Double Face Adder	30 1/4"	19 1/2"	72"	9 1/2"	8			\$ 3,934	
	DM-7224-S-SL-30-PB	Double Face Starter	31 1/4"	23 1/2"	72"	11 1/2"	8			\$ 4,687	
	DM-7224-A-SL-30-PB	Double Face Adder	30 1/4"	23 1/2"	72"	11 1/2"	8			\$ 4,004	
	DM-7220-S-SL-36-PB	Double Face Starter	37 1/4"	19 1/2"	72"	9 1/2"	8	200 Lbs.	12 Cu Ft	\$ 4,339	
	DM-7220-A-SL-36-PB	Double Face Adder	36 1/4"	19 1/2"	72"	9 1/2"	8	164 Lbs.	11 Cu Ft	\$ 3,654	
	DM-7224-S-SL-36-PB	Double Face Starter	37 1/4"	23 1/2"	72"	11 1/2"	8	229 Lbs.	13 Cu Ft	\$ 4,408	
	DM-7224-A-SL-36-PB	Double Face Adder	36 1/4"	23 1/2"	72"	11 1/2"	8	186 Lbs.	12 Cu Ft	\$ 3,717	

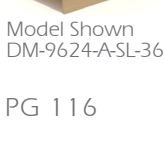
	MODEL NUMBER	PRODUCT	WIDTH	DEPTH	HEIGHT	SHELF DEPTH	# OF SHELVES	# OF OPENINGS	WEIGHT	VOLUME	LIST PRICE	DESCRIPTION
	DM-8220-S-SL-24-PB	Double Face Starter	25 1/4"	19 1/2"	82"	9 1/2"	10	12			\$ 4,960	End, Mid, Top and Base Panels to be constructed from 1" thick 11-ply solid core, veneered 2 sides. Vertical, top and bottom edges banded with 1/4" external hardwood edging, edges to be eased. Front Edge: 3/4" thick x 2 1/2" high fascia - tongue and grooved to top.
	DM-8220-A-SL-24-PB	Double Face Adder	24 1/4"	19 1/2"	82"	9 1/2"	10	12			\$ 4,283	
	DM-8224-S-SL-24-PB	Double Face Starter	25 1/4"	23 1/2"	82"	11 1/2"	10	12			\$ 5,045	
	DM-8224-A-SL-24-PB	Double Face Adder	24 1/4"	23 1/2"	82"	11 1/2"	10	12			\$ 4,361	
	DM-8220-S-SL-30-PB	Double Face Starter	31 1/4"	19 1/2"	82"	9 1/2"	10	12			\$ 4,960	
	DM-8220-A-SL-30-PB	Double Face Adder	30 1/4"	19 1/2"	82"	9 1/2"	10	12			\$ 4,283	
	DM-8224-S-SL-30-PB	Double Face Starter	31 1/4"	23 1/2"	82"	11 1/2"	10	12			\$ 5,045	
	DM-8224-A-SL-30-PB	Double Face Adder	30 1/4"	23 1/2"	82"	11 1/2"	10	12			\$ 4,361	
	DM-8220-S-SL-36-PB	Double Face Starter	37 1/4"	19 1/2"	82"	9 1/2"	10	12	224 Lbs.	12 Cu Ft	\$ 4,671	
	DM-8220-A-SL-36-PB	Double Face Adder	36 1/4"	19 1/2"	82"	9 1/2"	10	12	184 Lbs.	11 Cu Ft	\$ 3,987	
	DM-8224-S-SL-36-PB	Double Face Starter	37 1/4"	23 1/2"	82"	11 1/2"	10	12	256 Lbs.	14 Cu Ft	\$ 4,751	
	DM-8224-A-SL-36-PB	Double Face Adder	36 1/4"	23 1/2"	82"	11 1/2"	10	12	207 Lbs.	12 Cu Ft	\$ 4,080	
	DM-9620-S-SL-24-PB	Double Face Starter	25 1/4"	19 1/2"	96"	9 1/2"	12	14			\$ 5,310	
	DM-9620-A-SL-24-PB	Double Face Adder	24 1/4"	19 1/2"	96"	9 1/2"	12	14			\$ 4,626	
	DM-9624-S-SL-24-PB	Double Face Starter	25 1/4"	23 1/2"	96"	11 1/2"	12	14			\$ 5,403	
	DM-9624-A-SL-24-PB	Double Face Adder	24 1/4"	23 1/2"	96"	11 1/2"	12	14			\$ 4,727	
	DM-9620-S-SL-30-PB	Double Face Starter	31 1/4"	19 1/2"	96"	9 1/2"	12	14			\$ 5,310	
	DM-9620-A-SL-30-PB	Double Face Adder	30 1/4"	19 1/2"	96"	9 1/2"	12	14			\$ 4,626	
	DM-9624-S-SL-30-PB	Double Face Starter	31 1/4"	23 1/2"	96"	11 1/2"	12	14			\$ 5,403	
	DM-9624-A-SL-30-PB	Double Face Adder	30 1/4"	23 1/2"	96"	11 1/2"	12	14			\$ 4,727	
	DM-9620-S-SL-36-PB	Double Face Starter	37 1/4"	19 1/2"	96"	9 1/2"	12	14	276 Lbs.	13 Cu Ft	\$ 5,014	
	DM-9620-A-SL-36-PB	Double Face Adder	36 1/4"	19 1/2"	96"	9 1/2"	12	14	220 Lbs.	12 Cu Ft	\$ 4,329	
	DM-9624-S-SL-36-PB	Double Face Starter	37 1/4"	23 1/2"	96"	11 1/2"	12	14	315 Lbs.	15 Cu Ft	\$ 5,106	
	DM-9624-A-SL-36-PB	Double Face Adder	36 1/4"	23 1/2"	96"	11 1/2"	12	14	247 Lbs.	13 Cu Ft	\$ 4,439	

	MODEL NUMBER	PRODUCT	WIDTH	DEPTH	HEIGHT	SHELF DEPTH	# OF SHELVES	# OF OPENINGS	WEIGHT	VOLUME	LIST PRICE	DESCRIPTION
	DM-3610-S-SL-24-PB-IPT	Single Face Starter	25 1/4"	10 1/8"	36"	9 1/2"	1	2			\$ 1,703	End, Mid, Top and Base Panels to be constructed from 1" thick 11-ply solid core, veneered 2 sides. Vertical, top and bottom edges banded with 1/4" external hardwood edging, edges to be eased. Front Edge: 3/4" thick x 2 1/2" high fascia - tongue and grooved to top.
	DM-3610-A-SL-24-PB-IPT	Single Face Adder	24 1/4"	10 1/8"	36"	9 1/2"	1	2			\$ 1,323	
	DM-3612-S-SL-24-PB-IPT	Single Face Starter	25 1/4"	12 1/8"	36"	11 1/2"	1	2			\$ 1,757	
	DM-3612-A-SL-24-PB-IPT	Single Face Adder	24 1/4"	12 1/8"	36"	11 1/2"	1	2			\$ 1,360	
Model Shown DM-3612-S-SL-36-PB-IPT 	DM-3610-S-SL-30-PB-IPT	Single Face Starter	31 1/4"	10 1/8"	36"	9 1/2"	1	2			\$ 1,703	
	DM-3610-A-SL-30-PB-IPT	Single Face Adder	30 1/4"	10 1/8"	36"	9 1/2"	1	2			\$ 1,323	
	DM-3612-S-SL-30-PB-IPT	Single Face Starter	31 1/4"	12 1/8"	36"	11 1/2"	1	2			\$ 1,757	
	DM-3612-A-SL-30-PB-IPT	Single Face Adder	30 1/4"	12 1/8"	36"	11 1/2"	1	2			\$ 1,360	
Model Shown DM-3612-A-SL-36-PB-IPT 	DM-3610-S-SL-36-PB-IPT	Single Face Starter	37 1/4"	10 1/8"	36"	9 1/2"	1	2	50.6 Lbs.	4 Cu Ft	\$ 1,508	
	DM-3610-A-SL-36-PB-IPT	Single Face Adder	36 1/4"	10 1/8"	36"	9 1/2"	1	2	46 Lbs.	4 Cu Ft	\$ 1,135	
	DM-3612-S-SL-36-PB-IPT	Single Face Starter	37 1/4"	12 1/8"	36"	11 1/2"	1	2	50.6 Lbs.	5 Cu Ft	\$ 1,571	
	DM-3612-A-SL-36-PB-IPT	Single Face Adder	36 1/4"	12 1/8"	36"	11 1/2"	1	2	47.2 Lbs.	5 Cu Ft	\$ 1,166	
	DM-4210-S-SL-24-PB-IPT	Single Face Starter	25 1/4"	10 1/8"	42"	9 1/2"	2	3			\$ 2,083	
	DM-4210-A-SL-24-PB-IPT	Single Face Adder	24 1/4"	10 1/8"	42"	9 1/2"	2	3			\$ 1,710	
	DM-4212-S-SL-24-PB-IPT	Single Face Starter	25 1/4"	12 1/8"	42"	11 1/2"	2	3			\$ 2,139	
	DM-4212-A-SL-24-PB-IPT	Single Face Adder	24 1/4"	12 1/8"	42"	11 1/2"	2	3			\$ 1,741	
Model Shown DM-4212-S-SL-36-PB-IPT 	DM-4210-S-SL-30-PB-IPT	Single Face Starter	31 1/4"	10 1/8"	42"	9 1/2"	2	3			\$ 2,083	
	DM-4210-A-SL-30-PB-IPT	Single Face Adder	30 1/4"	10 1/8"	42"	9 1/2"	2	3			\$ 1,710	
	DM-4212-S-SL-30-PB-IPT	Single Face Starter	31 1/4"	12 1/8"	42"	11 1/2"	2	3			\$ 2,139	
	DM-4212-A-SL-30-PB-IPT	Single Face Adder	30 1/4"	12 1/8"	42"	11 1/2"	2	3			\$ 1,741	
Model Shown DM-4212-A-SL-36-PB-IPT 	DM-4210-S-SL-36-PB-IPT	Single Face Starter	37 1/4"	10 1/8"	42"	9 1/2"	2	3	55 Lbs.	5 Cu Ft	\$ 1,889	
	DM-4210-A-SL-36-PB-IPT	Single Face Adder	36 1/4"	10 1/8"	42"	9 1/2"	2	3	52 Lbs.	5 Cu Ft	\$ 1,486	
	DM-4212-S-SL-36-PB-IPT	Single Face Starter	37 1/4"	12 1/8"	42"	11 1/2"	2	3	60 Lbs.	5 Cu Ft	\$ 1,945	
	DM-4212-A-SL-36-PB-IPT	Single Face Adder	36 1/4"	12 1/8"	42"	11 1/2"	2	3	53 Lbs.	5 Cu Ft	\$ 1,555	
	DM-4810-S-SL-24-PB-IPT	Single Face Starter	25 1/4"	10 1/8"	48"	9 1/2"	2	3			\$ 2,107	
	DM-4810-A-SL-24-PB-IPT	Single Face Adder	24 1/4"	10 1/8"	48"	9 1/2"	2	3			\$ 1,710	
	DM-4812-S-SL-24-PB-IPT	Single Face Starter	25 1/4"	12 1/8"	48"	11 1/2"	2	3			\$ 2,153	
	DM-4812-A-SL-24-PB-IPT	Single Face Adder	24 1/4"	12 1/8"	48"	11 1/2"	2	3			\$ 1,741	
	DM-4810-S-SL-30-PB-IPT	Single Face Starter	31 1/4"	10 1/8"	48"	9 1/2"	2	3			\$ 2,107	
	DM-4810-A-SL-30-PB-IPT	Single Face Adder	30 1/4"	10 1/8"	48"	9 1/2"	2	3			\$ 1,710	
	DM-4812-S-SL-30-PB-IPT	Single Face Starter	31 1/4"	12 1/8"	48"	11 1/2"	2	3			\$ 2,153	
	DM-4812-A-SL-30-PB-IPT	Single Face Adder	30 1/4"	12 1/8"	48"	11 1/2"	2	3			\$ 1,741	
	DM-4810-S-SL-36-PB-IPT	Single Face Starter	37 1/4"	10 1/8"	48"	9 1/2"	2	3	74.8 Lbs.	5 Cu Ft	\$ 1,920	
	DM-4810-A-SL-36-PB-IPT	Single Face Adder	36 1/4"	10 1/8"	48"	9 1/2"	2	3	65.5 Lbs.	5 Cu Ft	\$ 1,524	
	DM-4812-S-SL-36-PB-IPT	Single Face Starter	37 1/4"	12 1/8"	48"	11 1/2"	2	3	82.8 Lbs.	6 Cu Ft	\$ 1,958	
	DM-4812-A-SL-36-PB-IPT	Single Face Adder	36 1/4"	12 1/8"	48"	11 1/2"	2	3	71.3 Lbs.	6 Cu Ft	\$ 1,555	

MODEL NUMBER	PRODUCT	WIDTH	DEPTH	HEIGHT	SHELF DEPTH	# OF SHELVES	# OF OPENINGS	WEIGHT	VOLUME	LIST PRICE	DESCRIPTION
DM-6010-S-SL-24-PB-IPT	Single Face Starter	25 1/4"	10 1/8"	60"	9 1/2"	3	4			\$ 2,401	End, Mid, Top and Base Panels to be constructed from 1" thick 11-ply solid core, veneered 2 sides. Vertical, top and bottom edges banded with 1/4" external hardwood edging, edges to be eased. Front Edge: 3/4" thick x 2 1/2" high fascia - tongue and grooved to top.
DM-6010-A-SL-24-PB-IPT	Single Face Adder	24 1/4"	10 1/8"	60"	9 1/2"	3	4			\$ 2,029	
DM-6012-S-SL-24-PB-IPT	Single Face Starter	25 1/4"	12 1/8"	60"	11 1/2"	3	4			\$ 2,456	
DM-6012-A-SL-24-PB-IPT	Single Face Adder	24 1/4"	12 1/8"	60"	11 1/2"	3	4			\$ 2,069	
DM-6010-S-SL-30-PB-IPT	Single Face Starter	31 1/4"	10 1/8"	60"	9 1/2"	3	4			\$ 2,401	
DM-6010-A-SL-30-PB-IPT	Single Face Adder	30 1/4"	10 1/8"	60"	9 1/2"	3	4			\$ 2,029	
DM-6012-S-SL-30-PB-IPT	Single Face Starter	31 1/4"	12 1/8"	60"	11 1/2"	3	4			\$ 2,456	
DM-6012-A-SL-30-PB-IPT	Single Face Adder	30 1/4"	12 1/8"	60"	11 1/2"	3	4			\$ 2,069	
DM-6010-S-SL-36-PB-IPT	Single Face Starter	37 1/4"	10 1/8"	60"	9 1/2"	3	4	100 Lbs.	6 Cu Ft	\$ 2,215	
DM-6010-A-SL-36-PB-IPT	Single Face Adder	36 1/4"	10 1/8"	60"	9 1/2"	3	4	86.3 Lbs.	6 Cu Ft	\$ 1,841	
DM-6012-S-SL-36-PB-IPT	Single Face Starter	37 1/4"	12 1/8"	60"	11 1/2"	3	4	116 Lbs.	8 Cu Ft	\$ 2,263	
DM-6012-A-SL-36-PB-IPT	Single Face Adder	36 1/4"	12 1/8"	60"	11 1/2"	3	4	95.5 Lbs.	7 Cu Ft	\$ 1,873	



Model Shown  
DM-6012-S-SL-36-PB-IPT



Model Shown  
DM-6012-A-SL-36-PB-IPT







	MODEL NUMBER	PRODUCT	WIDTH	DEPTH	HEIGHT	SHELF DEPTH	# OF SHELVES	# OF OPENINGS	WEIGHT	VOLUME	LIST PRICE	DESCRIPTION
	DM-3620-S-SL-24-PB-IPT	Double Face Starter	25 1/4"	19 1/2"	36"	9 1/2"	2	4			\$ 3,039	End, Mid, Top and Base Panels to be constructed from 1" thick 11-ply solid core, veneered 2 sides. Vertical, top and bottom edges banded with 1/4" external hardwood edging, edges to be eased. Front Edge: 3/4" thick x 2 1/2" high fascia - tongue and grooved to top.
	DM-3620-A-SL-24-PB-IPT	Double Face Adder	24 1/4"	19 1/2"	36"	9 1/2"	2	4			\$ 2,379	
	DM-3624-S-SL-24-PB-IPT	Double Face Starter	25 1/4"	23 1/2"	36"	11 1/2"	2	4			\$ 3,085	
	DM-3624-A-SL-24-PB-IPT	Double Face Adder	24 1/4"	23 1/2"	36"	11 1/2"	2	4			\$ 2,401	
Model Shown DM-3624-S-SL-36-PB-IPT 	DM-3620-S-SL-30-PB-IPT	Double Face Starter	31 1/4"	19 1/2"	36"	9 1/2"	2	4			\$ 3,039	
	DM-3620-A-SL-30-PB-IPT	Double Face Adder	30 1/4"	19 1/2"	36"	9 1/2"	2	4			\$ 2,379	
	DM-3624-S-SL-30-PB-IPT	Double Face Starter	31 1/4"	23 1/2"	36"	11 1/2"	2	4			\$ 3,085	
	DM-3624-A-SL-30-PB-IPT	Double Face Adder	30 1/4"	23 1/2"	36"	11 1/2"	2	4			\$ 2,401	
Model Shown DM-3624-A-SL-36-PB-IPT 	DM-3620-S-SL-36-PB-IPT	Double Face Starter	37 1/4"	19 1/2"	36"	9 1/2"	2	4	88.6 Lbs.	7 Cu Ft	\$ 2,744	
	DM-3620-A-SL-36-PB-IPT	Double Face Adder	36 1/4"	19 1/2"	36"	9 1/2"	2	4	73.6 Lbs.	6 Cu Ft	\$ 2,091	
	DM-3624-S-SL-36-PB-IPT	Double Face Starter	37 1/4"	23 1/2"	36"	11 1/2"	2	4	110 Lbs.	10 Cu Ft	\$ 2,791	
	DM-3624-A-SL-36-PB-IPT	Double Face Adder	36 1/4"	23 1/2"	36"	11 1/2"	2	4	88.6 Lbs.	9 Cu Ft	\$ 2,115	
	DM-4220-S-SL-24-PB-IPT	Double Face Starter	25 1/4"	19 1/2"	42"	9 1/2"	4	6			\$ 3,498	
	DM-4220-A-SL-24-PB-IPT	Double Face Adder	24 1/4"	19 1/2"	42"	9 1/2"	4	6			\$ 2,822	
	DM-4224-S-SL-24-PB-IPT	Double Face Starter	25 1/4"	23 1/2"	42"	11 1/2"	4	6			\$ 3,545	
	DM-4224-A-SL-24-PB-IPT	Double Face Adder	24 1/4"	23 1/2"	42"	11 1/2"	4	6			\$ 2,853	
Model Shown DM-4224-S-SL-36-PB-IPT 	DM-4220-S-SL-30-PB-IPT	Double Face Starter	31 1/4"	19 1/2"	42"	9 1/2"	4	6			\$ 3,498	
	DM-4220-A-SL-30-PB-IPT	Double Face Adder	30 1/4"	19 1/2"	42"	9 1/2"	4	6			\$ 2,822	
	DM-4224-S-SL-30-PB-IPT	Double Face Starter	31 1/4"	23 1/2"	42"	11 1/2"	4	6			\$ 3,545	
	DM-4224-A-SL-30-PB-IPT	Double Face Adder	30 1/4"	23 1/2"	42"	11 1/2"	4	6			\$ 2,853	
	DM-4220-S-SL-36-PB-IPT	Double Face Starter	37 1/4"	19 1/2"	42"	9 1/2"	4	6	94 Lbs.	7 Cu Ft	\$ 3,210	
	DM-4220-A-SL-36-PB-IPT	Double Face Adder	36 1/4"	19 1/2"	42"	9 1/2"	4	6	78 Lbs.	7 Cu Ft	\$ 2,535	
	DM-4224-S-SL-36-PB-IPT	Double Face Starter	37 1/4"	23 1/2"	42"	11 1/2"	4	6	115 Lbs.	10 Cu Ft	\$ 3,258	
	DM-4224-A-SL-36-PB-IPT	Double Face Adder	36 1/4"	23 1/2"	42"	11 1/2"	4	6	113 Lbs.	10 Cu Ft	\$ 2,558	
Model Shown DM-4224-A-SL-36-PB-IPT 	DM-4820-S-SL-24-PB-IPT	Double Face Starter	25 1/4"	19 1/2"	48"	9 1/2"	4	6			\$ 3,582	
	DM-4820-A-SL-24-PB-IPT	Double Face Adder	24 1/4"	19 1/2"	48"	9 1/2"	4	6			\$ 3,110	
	DM-4824-S-SL-24-PB-IPT	Double Face Starter	25 1/4"	23 1/2"	48"	11 1/2"	4	6			\$ 3,817	
	DM-4824-A-SL-24-PB-IPT	Double Face Adder	24 1/4"	23 1/2"	48"	11 1/2"	4	6			\$ 3,141	
	DM-4820-S-SL-30-PB-IPT	Double Face Starter	31 1/4"	19 1/2"	48"	9 1/2"	4	6			\$ 3,582	
	DM-4820-A-SL-30-PB-IPT	Double Face Adder	30 1/4"	19 1/2"	48"	9 1/2"	4	6			\$ 3,110	
	DM-4824-S-SL-30-PB-IPT	Double Face Starter	31 1/4"	23 1/2"	48"	11 1/2"	4	6			\$ 3,817	
	DM-4824-A-SL-30-PB-IPT	Double Face Adder	30 1/4"	23 1/2"	48"	11 1/2"	4	6			\$ 3,141	
	DM-4820-S-SL-36-PB-IPT	Double Face Starter	37 1/4"	19 1/2"	48"	9 1/2"	4	6	132 Lbs.	9 Cu Ft	\$ 3,475	
	DM-4820-A-SL-36-PB-IPT	Double Face Adder	36 1/4"	19 1/2"	48"	9 1/2"	4	6	109 Lbs.	8 Cu Ft	\$ 2,822	
	DM-4824-S-SL-36-PB-IPT	Double Face Starter	37 1/4"	23 1/2"	48"	11 1/2"	4	6	155 Lbs.	11 Cu Ft	\$ 3,529	
	DM-4824-A-SL-36-PB-IPT	Double Face Adder	36 1/4"	23 1/2"	48"	11 1/2"	4	6	127 Lbs.	10 Cu Ft	\$ 2,853	

MODEL NUMBER	PRODUCT	WIDTH	DEPTH	HEIGHT	SHELF DEPTH	# OF SHELVES	# OF OPENINGS	WEIGHT	VOLUME	LIST PRICE	DESCRIPTION
	DM-6020-S-SL-24-PB-IPT	Double Face Starter	25 1/4"	19 1/2"	60"	9 1/2"	6			\$ 4,315	End, Mid, Top and Base Panels to be constructed from 1" thick 11-ply solid core, veneered 2 sides. Vertical, top and bottom edges banded with 1/4" external hardwood edging, edges to be eased. Front Edge: 3/4" thick x 2 1/2" high fascia - tongue and grooved to top.
	DM-6020-A-SL-24-PB-IPT	Double Face Adder	24 1/4"	19 1/2"	60"	9 1/2"	6			\$ 3,614	
	DM-6024-S-SL-24-PB-IPT	Double Face Starter	25 1/4"	23 1/2"	60"	11 1/2"	6			\$ 4,353	
	DM-6024-A-SL-24-PB-IPT	Double Face Adder	24 1/4"	23 1/2"	60"	11 1/2"	6			\$ 3,686	
	DM-6020-S-SL-30-PB-IPT	Double Face Starter	31 1/4"	19 1/2"	60"	9 1/2"	6			\$ 4,315	
	DM-6020-A-SL-30-PB-IPT	Double Face Adder	30 1/4"	19 1/2"	60"	9 1/2"	6			\$ 3,614	
	DM-6024-S-SL-30-PB-IPT	Double Face Starter	31 1/4"	23 1/2"	60"	11 1/2"	6			\$ 4,353	
	DM-6024-A-SL-30-PB-IPT	Double Face Adder	30 1/4"	23 1/2"	60"	11 1/2"	6			\$ 3,686	
	DM-6020-S-SL-36-PB-IPT	Double Face Starter	37 1/4"	19 1/2"	60"	9 1/2"	6	176 Lbs.	11 Cu Ft	\$ 4,050	
	DM-6020-A-SL-36-PB-IPT	Double Face Adder	36 1/4"	19 1/2"	60"	9 1/2"	6	145 Lbs.	10 Cu Ft	\$ 3,334	
	DM-6024-S-SL-36-PB-IPT	Double Face Starter	37 1/4"	23 1/2"	60"	11 1/2"	6	200 Lbs.	12 Cu Ft	\$ 4,073	
	DM-6024-A-SL-36-PB-IPT	Double Face Adder	36 1/4"	23 1/2"	60"	11 1/2"	6	164 Lbs.	11 Cu Ft	\$ 3,397	

Model Shown  
DM-6024-S-SL-36-PB-IPT



Model Shown  
DM-6024-A-SL-36-PB-IPT

	MODEL NUMBER	PRODUCT	WIDTH	DEPTH	HEIGHT	SHELF DEPTH	# OF SHELVES	# OF OPENINGS	WEIGHT	VOLUME	LIST PRICE	DESCRIPTION
 Model Shown DM-3612-S-M-36	DM-3612-S-M-24	Single Face Starter	25 1/4"	12 1/8"	36"		1	2			\$ 1,772	End, Mid, Top and Base Panels to be constructed from 1" thick 11-ply solid core, veneered 2 sides. Vertical, top and bottom edges banded with 1/4" external hardwood edging, edges to be eased. Front Edge: 3/4" thick x 2 1/2" high fascia - tongue and grooved to top.
	DM-3612-A-M-24	Single Face Adder	24 1/4"	12 1/8"	36"		1	2			\$ 1,360	
	DM-3612-S-M-30	Single Face Starter	31 1/4"	12 1/8"	36"		1	2			\$ 1,772	
	DM-3612-A-M-30	Single Face Adder	30 1/4"	12 1/8"	36"		1	2			\$ 1,360	
	DM-3612-S-M-36	Single Face Starter	37 1/4"	12 1/8"	36"		1	2	80.5 Lbs.	6 Cu Ft	\$ 1,578	
	DM-3612-A-M-36	Single Face Adder	36 1/4"	12 1/8"	36"		1	2	77.1 Lbs.	6 Cu Ft	\$ 1,166	
 Model Shown DM-3612-A-M-36	DM-4212-S-M-24	Single Face Starter	25 1/4"	12 1/8"	42"		2	3			\$ 2,076	
	DM-4212-A-M-24	Single Face Adder	24 1/4"	12 1/8"	42"		2	3			\$ 1,671	
	DM-4212-S-M-30	Single Face Starter	31 1/4"	12 1/8"	42"		2	3			\$ 2,091	
	DM-4212-A-M-30	Single Face Adder	30 1/4"	12 1/8"	42"		2	3			\$ 1,671	
	DM-4212-S-M-36	Single Face Starter	37 1/4"	12 1/8"	42"		2	3	82.5 Lbs.	7 Cu Ft	\$ 1,889	
	DM-4212-A-M-36	Single Face Adder	36 1/4"	12 1/8"	42"		2	3	80 Lbs.	7 Cu Ft	\$ 1,478	
 Model Shown DM-4212-S-M-36	DM-4812-S-M-24	Single Face Starter	25 1/4"	12 1/8"	48"		2	3			\$ 2,200	
	DM-4812-A-M-24	Single Face Adder	24 1/4"	12 1/8"	48"		2	3			\$ 1,748	
	DM-4812-S-M-30	Single Face Starter	31 1/4"	12 1/8"	48"		2	3			\$ 2,200	
	DM-4812-A-M-30	Single Face Adder	30 1/4"	12 1/8"	48"		2	3			\$ 1,748	
	DM-4812-S-M-36	Single Face Starter	37 1/4"	12 1/8"	48"		2	3	128 Lbs.	7 Cu Ft	\$ 1,976	
	DM-4812-A-M-36	Single Face Adder	36 1/4"	12 1/8"	48"		2	3	116 Lbs.	7 Cu Ft	\$ 1,547	
 Model Shown DM-4212-A-M-36	DM-6012-S-M-24	Single Face Starter	25 1/4"	12 1/8"	60"		3	4			\$ 2,317	
	DM-6012-A-M-24	Single Face Adder	24 1/4"	12 1/8"	60"		3	4			\$ 1,912	
	DM-6012-S-M-30	Single Face Starter	31 1/4"	12 1/8"	60"		3	4			\$ 2,317	
	DM-6012-A-M-30	Single Face Adder	30 1/4"	12 1/8"	60"		3	4			\$ 1,912	
	DM-6012-S-M-36	Single Face Starter	37 1/4"	12 1/8"	60"		3	4	176 Lbs.	10 Cu Ft	\$ 2,122	
	DM-6012-A-M-36	Single Face Adder	36 1/4"	12 1/8"	60"		3	4	155 Lbs.	9 Cu Ft	\$ 1,717	
 Model Shown DM-6012-S-M-36	DM-6012-S-M-36	Single Face Starter	37 1/4"	12 1/8"	60"		3	4	176 Lbs.	10 Cu Ft	\$ 2,122	
	DM-6012-A-M-36	Single Face Adder	36 1/4"	12 1/8"	60"		3	4	155 Lbs.	9 Cu Ft	\$ 1,717	
	 Model Shown DM-6012-A-M-36	DM-6012-S-M-36	Single Face Starter	37 1/4"	12 1/8"	60"		3	4	176 Lbs.	10 Cu Ft	\$ 2,122
		DM-6012-A-M-36	Single Face Adder	36 1/4"	12 1/8"	60"		3	4	155 Lbs.	9 Cu Ft	\$ 1,717



MODEL NUMBER	PRODUCT	WIDTH	DEPTH	HEIGHT	SHELF DEPTH	# OF SHELVES	# OF OPENINGS	WEIGHT	VOLUME	LIST PRICE	DESCRIPTION
DM-7212-S-M-24	Single Face Starter	25 1/4"	12 1/8"	72"		4	5			\$ 2,619	End, Mid, Top and Base Panels to be constructed from 1" thick 11-ply solid core, veneered 2 sides. Vertical, top and bottom edges banded with 1/4" external hardwood edging, edges to be eased. Front Edge: 3/4" thick x 2 1/2" high fascia - tongue and grooved to top.
DM-7212-A-M-24	Single Face Adder	24 1/4"	12 1/8"	72"		4	5			\$ 2,215	
DM-7212-S-M-30	Single Face Starter	31 1/4"	12 1/8"	72"		4	5			\$ 2,619	
DM-7212-A-M-30	Single Face Adder	30 1/4"	12 1/8"	72"		4	5			\$ 2,215	
DM-7212-S-M-36	Single Face Starter	37 1/4"	12 1/8"	72"		4	5	206 Lbs.	11 Cu Ft	\$ 2,433	
DM-7212-A-M-36	Single Face Adder	36 1/4"	12 1/8"	72"		4	5	184 Lbs.	10 Cu Ft	\$ 2,014	



Model Shown  
DM-7212-S-M-36



Model Shown  
DM-7212-A-M-36







DM-8212-S-M-24	Single Face Starter	25 1/4"	12 1/8"	82"		5	6			\$ 2,921	
DM-8212-A-M-24	Single Face Adder	24 1/4"	12 1/8"	82"		5	6			\$ 2,498	
DM-8212-S-M-30	Single Face Starter	31 1/4"	12 1/8"	82"		5	6			\$ 2,921	
DM-8212-A-M-30	Single Face Adder	30 1/4"	12 1/8"	82"		5	6			\$ 2,498	
DM-8212-S-M-36	Single Face Starter	37 1/4"	12 1/8"	82"		5	6	236 Lbs.	12 Cu Ft	\$ 2,744	
DM-8212-A-M-36	Single Face Adder	36 1/4"	12 1/8"	82"		5	6	213 Lbs.	11 Cu Ft	\$ 2,312	



Model Shown  
DM-8212-S-M-36



Model Shown  
DM-8212-A-M-36

	MODEL NUMBER	PRODUCT	WIDTH	DEPTH	HEIGHT	SHELF DEPTH	# OF SHELVES	# OF OPENINGS	WEIGHT	VOLUME	LIST PRICE	DESCRIPTION
 <p>Model Shown DM-3624-S-M-36</p>	DM-3624-S-M-24	Single Face Starter	25 1/4"	23 1/2"	36"		2	4			\$ 3,195	End, Mid, Top and Base Panels to be constructed from 1" thick 11-ply solid core, veneered 2 sides. Vertical, top and bottom edges banded with 1/4" external hardwood edging, edges to be eased. Front Edge: 3/4" thick x 2 1/2" high fascia - tongue and grooved to top.
	DM-3624-A-M-24	Single Face Adder	24 1/4"	23 1/2"	36"		2	4			\$ 2,487	
	DM-3624-S-M-30	Single Face Starter	31 1/4"	23 1/2"	36"		2	4			\$ 3,195	
	DM-3624-A-M-30	Single Face Adder	30 1/4"	23 1/2"	36"		2	4			\$ 2,487	
	DM-3624-S-M-36	Single Face Starter	37 1/4"	23 1/2"	36"		2	4	170 Lbs.	12 Cu Ft	\$ 2,899	
	DM-3624-A-M-36	Single Face Adder	36 1/4"	23 1/2"	36"		2	4	148 Lbs.	11 Cu Ft	\$ 2,200	
 <p>Model Shown DM-3624-A-M-36</p>	DM-4224-S-M-24	Single Face Starter	25 1/4"	23 1/2"	42"		4	6			\$ 3,786	
	DM-4224-A-M-24	Single Face Adder	24 1/4"	23 1/2"	42"		4	6			\$ 3,095	
	DM-4224-S-M-30	Single Face Starter	31 1/4"	23 1/2"	42"		4	6			\$ 3,786	
	DM-4224-A-M-30	Single Face Adder	30 1/4"	23 1/2"	42"		4	6			\$ 3,095	
	DM-4224-S-M-36	Single Face Starter	37 1/4"	23 1/2"	42"		4	6	180 Lbs.	13 Cu Ft	\$ 3,498	
	DM-4224-A-M-36	Single Face Adder	36 1/4"	23 1/2"	42"		4	6	158 Lbs.	12 Cu Ft	\$ 2,806	
 <p>Model Shown DM-4224-S-M-36</p>	DM-4824-S-M-24	Single Face Starter	25 1/4"	23 1/2"	48"		4	6			\$ 3,973	
	DM-4824-A-M-24	Single Face Adder	24 1/4"	23 1/2"	48"		4	6			\$ 3,250	
	DM-4824-S-M-30	Single Face Starter	31 1/4"	23 1/2"	48"		4	6			\$ 3,973	
	DM-4824-A-M-30	Single Face Adder	30 1/4"	23 1/2"	48"		4	6			\$ 3,250	
	DM-4824-S-M-36	Single Face Starter	37 1/4"	23 1/2"	48"		4	6	245 Lbs.	14 Cu Ft	\$ 3,677	
	DM-4824-A-M-36	Single Face Adder	36 1/4"	23 1/2"	48"		4	6	216 Lbs.	13 Cu Ft	\$ 2,939	
 <p>Model Shown DM-4224-A-M-36</p>	DM-6024-S-M-24	Single Face Starter	25 1/4"	23 1/2"	60"		6	8			\$ 4,283	
	DM-6024-A-M-24	Single Face Adder	24 1/4"	23 1/2"	60"		6	8			\$ 3,575	
	DM-6024-S-M-30	Single Face Starter	31 1/4"	23 1/2"	60"		6	8			\$ 4,283	
	DM-6024-A-M-30	Single Face Adder	30 1/4"	23 1/2"	60"		6	8			\$ 3,575	
	DM-6024-S-M-36	Single Face Starter	37 1/4"	23 1/2"	60"		6	8	320 Lbs.	16 Cu Ft	\$ 3,987	
	DM-6024-A-M-36	Single Face Adder	36 1/4"	23 1/2"	60"		6	8	284 Lbs.	15 Cu Ft	\$ 3,288	
 <p>Model Shown DM-6024-S-M-36</p>	DM-6024-S-M-36	Single Face Starter	37 1/4"	23 1/2"	60"		6	8	320 Lbs.	16 Cu Ft	\$ 3,987	
	DM-6024-A-M-36	Single Face Adder	36 1/4"	23 1/2"	60"		6	8	284 Lbs.	15 Cu Ft	\$ 3,288	
	 <p>Model Shown DM-6024-A-M-36</p>	DM-6024-S-M-36	Single Face Starter	37 1/4"	23 1/2"	60"		6	8	320 Lbs.	16 Cu Ft	\$ 3,987
		DM-6024-A-M-36	Single Face Adder	36 1/4"	23 1/2"	60"		6	8	284 Lbs.	15 Cu Ft	\$ 3,288

MODEL NUMBER	PRODUCT	WIDTH	DEPTH	HEIGHT	SHELF DEPTH	# OF SHELVES	# OF OPENINGS	WEIGHT	VOLUME	LIST PRICE	DESCRIPTION
DM-7224-S-M-24	Single Face Starter	25 1/4"	23 1/2"	72"		8	10			\$ 4,875	End, Mid, Top and Base Panels to be constructed from 1" thick 11-ply solid core, veneered 2 sides. Vertical, top and bottom edges banded with 1/4" external hardwood edging, edges to be eased. Front Edge: 3/4" thick x 2 1/2" high fascia - tongue and grooved to top.
DM-7224-A-M-24	Single Face Adder	24 1/4"	23 1/2"	72"		8	10			\$ 4,158	
DM-7224-S-M-30	Single Face Starter	31 1/4"	23 1/2"	72"		8	10			\$ 4,875	
DM-7224-A-M-30	Single Face Adder	30 1/4"	23 1/2"	72"		8	10			\$ 4,158	
DM-7224-S-M-36	Single Face Starter	37 1/4"	23 1/2"	72"		8	10	378 Lbs.	18 Cu Ft	\$ 4,578	
DM-7224-A-M-36	Single Face Adder	36 1/4"	23 1/2"	72"		8	10	336 Lbs.	17 Cu Ft	\$ 3,880	



Model Shown  
DM-7224-S-M-36



Model Shown  
DM-7224-A-M-36







DM-8224-S-M-24	Single Face Starter	25 1/4"	23 1/2"	82"		10	12			\$ 5,465	
DM-8224-A-M-24	Single Face Adder	24 1/4"	23 1/2"	82"		10	12			\$ 4,741	
DM-8224-S-M-30	Single Face Starter	31 1/4"	23 1/2"	82"		10	12			\$ 5,465	
DM-8224-A-M-30	Single Face Adder	30 1/4"	23 1/2"	82"		10	12			\$ 4,741	
DM-8224-S-M-36	Single Face Starter	37 1/4"	23 1/2"	82"		10	12	436 Lbs.	20 Cu Ft	\$ 5,169	
DM-8224-A-M-36	Single Face Adder	36 1/4"	23 1/2"	82"		10	12	388 Lbs.	19 Cu Ft	\$ 4,470	













Model Shown  
DM-8224-S-M-36







Model Shown  
DM-8224-A-M-36

	MODEL NUMBER	PRODUCT	WIDTH	DEPTH	HEIGHT	SHELF DEPTH	# OF SHELVES	# OF OPENINGS	WEIGHT	VOLUME	LIST PRICE	DESCRIPTION
 Model Shown DM-3612-S-M-36-IPT	DM-3612-S-M-24-IPT	Single Face Starter	25 1/4"	12 1/8"	36"		1	2			\$ 1,873	End, Mid, Top and Base Panels to be constructed from 1" thick 11-ply solid core, veneered 2 sides. Vertical, top and bottom edges banded with 1/4" external hardwood edging, edges to be eased. Front Edge: 3/4" thick x 2 1/2" high fascia - tongue and grooved to top.
	DM-3612-A-M-24-IPT	Single Face Adder	24 1/4"	12 1/8"	36"		1	2			\$ 1,462	
	DM-3612-S-M-30-IPT	Single Face Starter	31 1/4"	12 1/8"	36"		1	2			\$ 1,873	
	DM-3612-A-M-30-IPT	Single Face Adder	30 1/4"	12 1/8"	36"		1	2			\$ 1,462	
	DM-3612-S-M-36-IPT	Single Face Starter	37 1/4"	12 1/8"	36"		1	2	80.5 Lbs.	6 Cu Ft	\$ 1,680	
	DM-3612-A-M-36-IPT	Single Face Adder	36 1/4"	12 1/8"	36"		1	2	77.1 Lbs.	6 Cu Ft	\$ 1,268	
 Model Shown DM-3612-A-M-36-IPT												
 Model Shown DM-4212-S-M-36-IPT	DM-4212-S-M-24-IPT	Single Face Starter	25 1/4"	12 1/8"	42"		2	3			\$ 2,169	
	DM-4212-A-M-24-IPT	Single Face Adder	24 1/4"	12 1/8"	42"		2	3			\$ 1,765	
	DM-4212-S-M-30-IPT	Single Face Starter	31 1/4"	12 1/8"	42"		2	3			\$ 2,169	
	DM-4212-A-M-30-IPT	Single Face Adder	30 1/4"	12 1/8"	42"		2	3			\$ 1,765	
	DM-4212-S-M-36-IPT	Single Face Starter	37 1/4"	12 1/8"	42"		2	3	82.5 Lbs.	7 Cu Ft	\$ 1,983	
	DM-4212-A-M-36-IPT	Single Face Adder	36 1/4"	12 1/8"	42"		2	3	80 Lbs.	7 Cu Ft	\$ 1,571	
 Model Shown DM-4212-A-M-36-IPT	DM-4812-S-M-24-IPT	Single Face Starter	25 1/4"	12 1/8"	48"		2	3			\$ 2,293	
	DM-4812-A-M-24-IPT	Single Face Adder	24 1/4"	12 1/8"	48"		2	3			\$ 1,851	
	DM-4812-S-M-30-IPT	Single Face Starter	31 1/4"	12 1/8"	48"		2	3			\$ 2,293	
	DM-4812-A-M-30-IPT	Single Face Adder	30 1/4"	12 1/8"	48"		2	3			\$ 1,851	
	DM-4812-S-M-36-IPT	Single Face Starter	37 1/4"	12 1/8"	48"		2	3	128 Lbs.	7 Cu Ft	\$ 2,076	
	DM-4812-A-M-36-IPT	Single Face Adder	36 1/4"	12 1/8"	48"		2	3	116 Lbs.	7 Cu Ft	\$ 1,648	
 Model Shown DM-6012-S-M-36-IPT	DM-6012-S-M-24-IPT	Single Face Starter	25 1/4"	12 1/8"	60"		3	4			\$ 2,417	
	DM-6012-A-M-24-IPT	Single Face Adder	24 1/4"	12 1/8"	60"		3	4			\$ 2,014	
	DM-6012-S-M-30-IPT	Single Face Starter	31 1/4"	12 1/8"	60"		3	4			\$ 2,417	
	DM-6012-A-M-30-IPT	Single Face Adder	30 1/4"	12 1/8"	60"		3	4			\$ 2,014	
	DM-6012-S-M-36-IPT	Single Face Starter	37 1/4"	12 1/8"	60"		3	4	176 Lbs.	10 Cu Ft	\$ 2,215	
	DM-6012-A-M-36-IPT	Single Face Adder	36 1/4"	12 1/8"	60"		3	4	155 Lbs.	9 Cu Ft	\$ 1,811	
 Model Shown DM-6012-A-M-36-IPT												





	MODEL NUMBER	PRODUCT	WIDTH	DEPTH	HEIGHT	SHELF DEPTH	# OF SHELVES	# OF OPENINGS	WEIGHT	VOLUME	LIST PRICE	DESCRIPTION
 <p>Model Shown DM-3624-S-M-36-IPT</p>	DM-3624-S-M-24-IPT	Single Face Starter	25 1/4"	23 1/2"	36"		2	4			\$ 3,365	End, Mid, Top and Base Panels to be constructed from 1" thick 11-ply solid core, veneered 2 sides. Vertical, top and bottom edges banded with 1/4" external hardwood edging, edges to be eased. Front Edge: 3/4" thick x 2 1/2" high fascia - tongue and grooved to top.
	DM-3624-A-M-24-IPT	Single Face Adder	24 1/4"	23 1/2"	36"		2	4			\$ 2,682	
	DM-3624-S-M-30-IPT	Single Face Starter	31 1/4"	23 1/2"	36"		2	4			\$ 3,365	
	DM-3624-A-M-30-IPT	Single Face Adder	30 1/4"	23 1/2"	36"		2	4			\$ 2,682	
	DM-3624-S-M-36-IPT	Single Face Starter	37 1/4"	23 1/2"	36"		2	4	170 Lbs.	12 Cu Ft	\$ 3,095	
	DM-3624-A-M-36-IPT	Single Face Adder	36 1/4"	23 1/2"	36"		2	4	148 Lbs.	11 Cu Ft	\$ 2,387	
 <p>Model Shown DM-3624-A-M-36-IPT</p>	DM-4224-S-M-24-IPT	Single Face Starter	25 1/4"	23 1/2"	42"		4	6			\$ 3,980	
	DM-4224-A-M-24-IPT	Single Face Adder	24 1/4"	23 1/2"	42"		4	6			\$ 3,288	
	DM-4224-S-M-30-IPT	Single Face Starter	31 1/4"	23 1/2"	42"		4	6			\$ 3,980	
	DM-4224-A-M-30-IPT	Single Face Adder	30 1/4"	23 1/2"	42"		4	6			\$ 3,288	
	DM-4224-S-M-36-IPT	Single Face Starter	37 1/4"	23 1/2"	42"		4	6	180 Lbs.	13 Cu Ft	\$ 3,693	
	DM-4224-A-M-36-IPT	Single Face Adder	36 1/4"	23 1/2"	42"		4	6	158 Lbs.	12 Cu Ft	\$ 2,992	
 <p>Model Shown DM-4224-S-M-36-IPT</p>	DM-4824-S-M-24-IPT	Single Face Starter	25 1/4"	23 1/2"	48"		4	6			\$ 4,168	
	DM-4824-A-M-24-IPT	Single Face Adder	24 1/4"	23 1/2"	48"		4	6			\$ 3,444	
	DM-4824-S-M-30-IPT	Single Face Starter	31 1/4"	23 1/2"	48"		4	6			\$ 4,168	
	DM-4824-A-M-30-IPT	Single Face Adder	30 1/4"	23 1/2"	48"		4	6			\$ 3,444	
	DM-4824-S-M-36-IPT	Single Face Starter	37 1/4"	23 1/2"	48"		4	6	245 Lbs.	14 Cu Ft	\$ 3,903	
	DM-4824-A-M-36-IPT	Single Face Adder	36 1/4"	23 1/2"	48"		4	6	216 Lbs.	13 Cu Ft	\$ 3,134	
 <p>Model Shown DM-4224-A-M-36-IPT</p>	DM-6024-S-M-24-IPT	Single Face Starter	25 1/4"	23 1/2"	60"		6	8			\$ 4,315	
	DM-6024-A-M-24-IPT	Single Face Adder	24 1/4"	23 1/2"	60"		6	8			\$ 3,770	
	DM-6024-S-M-30-IPT	Single Face Starter	31 1/4"	23 1/2"	60"		6	8			\$ 4,315	
	DM-6024-A-M-30-IPT	Single Face Adder	30 1/4"	23 1/2"	60"		6	8			\$ 3,770	
	DM-6024-S-M-36-IPT	Single Face Starter	37 1/4"	23 1/2"	60"		6	8	320 Lbs.	16 Cu Ft	\$ 4,222	
	DM-6024-A-M-36-IPT	Single Face Adder	36 1/4"	23 1/2"	60"		6	8	284 Lbs.	15 Cu Ft	\$ 3,482	
 <p>Model Shown DM-6024-A-M-36-IPT</p>												

	MODEL NUMBER	PRODUCT	WIDTH	DEPTH	HEIGHT	SHELF DEPTH	# OF SHELVES	# OF OPENINGS	WEIGHT	VOLUME	LIST PRICE	DESCRIPTION
 <p>Model Shown DM-AF-4818-S-36</p>		A-Frame Shelving, Single Face										
	DM-AF-4818-S-36	Starter	37 <sup>3</sup> / <sub>8</sub> "	18"	48"	5 <sup>3</sup> / <sub>8</sub> "	3	4			\$ 1,758	
	DM-AF-4818-A-36	Adder	36 <sup>1</sup> / <sub>4</sub> "	18"	48"	5 <sup>3</sup> / <sub>8</sub> "	3	4			\$ 1,236	
	DM-AF-6018-S-36	Starter	37 <sup>3</sup> / <sub>8</sub> "	18"	60"	5 <sup>3</sup> / <sub>8</sub> "	4	5			\$ 1,899	
	DM-AF-6018-A-36	Adder	36 <sup>1</sup> / <sub>4</sub> "	18"	60"	5 <sup>3</sup> / <sub>8</sub> "	4	5			\$ 1,392	
	DM-AF-7218-S-36	Starter	37 <sup>3</sup> / <sub>8</sub> "	18"	72"	5 <sup>3</sup> / <sub>8</sub> "	5	6			\$ 2,012	
	DM-AF-7218-A-36	Adder	36 <sup>1</sup> / <sub>4</sub> "	18"	72"	5 <sup>3</sup> / <sub>8</sub> "	5	6			\$ 1,529	
 <p>Model Shown DM-AF-4818-A-36</p>												
 <p>Model Shown DM-AF-4824-S-36</p>		A-Frame Shelving, Double Face										
	DM-AF-4824-S-36	Starter	37 <sup>3</sup> / <sub>8</sub> "	24"	48"	5 <sup>3</sup> / <sub>8</sub> "	6	8			\$ 2,800	
	DM-AF-4824-A-36	Adder	36 <sup>1</sup> / <sub>4</sub> "	24"	48"	5 <sup>3</sup> / <sub>8</sub> "	6	8			\$ 1,989	
	DM-AF-6024-S-36	Starter	37 <sup>3</sup> / <sub>8</sub> "	24"	60"	5 <sup>3</sup> / <sub>8</sub> "	8	10			\$ 2,883	
	DM-AF-6024-A-36	Adder	36 <sup>1</sup> / <sub>4</sub> "	24"	60"	5 <sup>3</sup> / <sub>8</sub> "	8	10			\$ 2,070	
	DM-AF-7224-S-36	Starter	37 <sup>3</sup> / <sub>8</sub> "	24"	72"	5 <sup>3</sup> / <sub>8</sub> "	10	12			\$ 3,085	
	DM-AF-7224-A-36	Adder	36 <sup>1</sup> / <sub>4</sub> "	24"	72"	5 <sup>3</sup> / <sub>8</sub> "	10	12			\$ 2,278	
 <p>Model Shown DM-AF-4824-A-36</p>												
 <p>Model Shown DM-AF-4824-S-36-SW</p>		A-Frame Shelving, Double Face, Slatwall End Panel										
	DM-AF-4824-S-36-SW	Starter	37 <sup>3</sup> / <sub>8</sub> "	24"	48"	5 <sup>3</sup> / <sub>8</sub> "	6	8			\$ 2,977	
	DM-AF-4824-A-36-SW	Adder	36 <sup>1</sup> / <sub>4</sub> "	24"	48"	5 <sup>3</sup> / <sub>8</sub> "	6	8			\$ 1,989	
	DM-AF-6024-S-36-SW	Starter	37 <sup>3</sup> / <sub>8</sub> "	24"	60"	5 <sup>3</sup> / <sub>8</sub> "	8	10			\$ 3,125	
	DM-AF-6024-A-36-SW	Adder	36 <sup>1</sup> / <sub>4</sub> "	24"	60"	5 <sup>3</sup> / <sub>8</sub> "	8	10			\$ 2,070	
	DM-AF-7224-S-36-SW	Starter	37 <sup>3</sup> / <sub>8</sub> "	24"	72"	5 <sup>3</sup> / <sub>8</sub> "	10	12			\$ 3,381	
	DM-AF-7224-A-36-SW	Adder	36 <sup>1</sup> / <sub>4</sub> "	24"	72"	5 <sup>3</sup> / <sub>8</sub> "	10	12			\$ 2,278	
 <p>Model Shown DM-AF-4824-A-36-SW</p>												

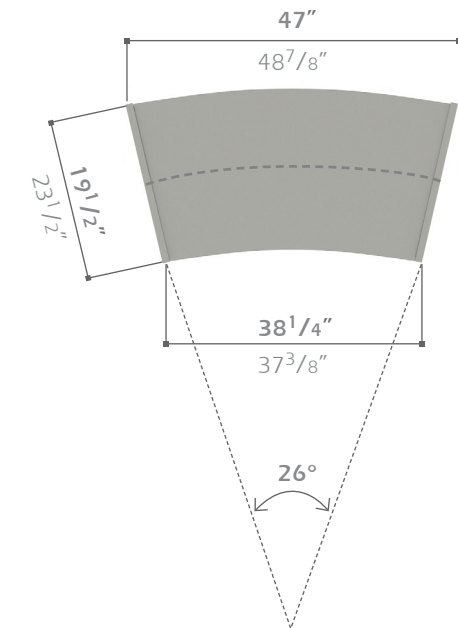
	MODEL NUMBER	PRODUCT	WIDTH	DEPTH	HEIGHT	SHELF DEPTH	# OF SHELVES	# OF OPENINGS	WEIGHT	VOLUME	LIST PRICE	
 Model Shown DM-CV-3624-S-36		26° Curved Shelving, Double Face										
	DM-CV-3620-S-36	Starter	47"	19 1/2"	36"		2	4	88.6 Lbs.	7 Cu Ft	\$ 3,029	
	DM-CV-3620-A-36	Adder	46"	19 1/2"	36"		2	4	73.6 Lbs.	6 Cu Ft	\$ 2,069	
	DM-CV-3624-S-36	Starter	48 7/8"	23 1/2"	36"		2	4	110 Lbs.	10 Cu Ft	\$ 3,097	
	DM-CV-3624-A-36	Adder	47 7/8"	23 1/2"	36"		2	4	95 Lbs.	9 Cu Ft	\$ 2,103	
 Model Shown DM-CV-4224-A-36		26° Curved Shelving, Double Face										
	DM-CV-4220-S-36	Starter	47"	19 1/2"	42"		4	6	94 Lbs.	7 Cu Ft	\$ 3,349	
	DM-CV-4220-A-36	Adder	46"	19 1/2"	42"		4	6	78 Lbs.	7 Cu Ft	\$ 2,386	
	DM-CV-4224-S-36	Starter	48 7/8"	23 1/2"	42"		4	6	115 Lbs.	10 Cu Ft	\$ 3,428	
	DM-CV-4224-A-36	Adder	47 7/8"	23 1/2"	42"		4	6	113 Lbs.	10 Cu Ft	\$ 2,432	
 Model Shown DM-CV-4824-S-36		26° Curved Shelving, Double Face										
	DM-CV-4820-S-36	Starter	47"	19 1/2"	48"		4	6	132 Lbs.	9 Cu Ft	\$ 3,474	
	DM-CV-4820-A-36	Adder	46"	19 1/2"	48"		4	6	109 Lbs.	8 Cu Ft	\$ 2,487	
	DM-CV-4824-S-36	Starter	48 7/8"	23 1/2"	48"		4	6	155 Lbs.	11 Cu Ft	\$ 3,564	
	DM-CV-4824-A-36	Adder	47 7/8"	23 1/2"	48"		4	6	127 Lbs.	10 Cu Ft	\$ 2,533	
 Model Shown DM-CV-6024-S-36		26° Curved Shelving, Double Face										
	DM-CV-6020-S-36	Starter	47"	19 1/2"	60"		6	8	176 Lbs.	11 Cu Ft	\$ 3,585	
	DM-CV-6020-A-36	Adder	46"	19 1/2"	60"		6	8	145 Lbs.	10 Cu Ft	\$ 2,573	
	DM-CV-6024-S-36	Starter	48 7/8"	23 1/2"	60"		6	8	200 Lbs.	12 Cu Ft	\$ 3,675	
	DM-CV-6024-A-36	Adder	47 7/8"	23 1/2"	60"		6	8	164 Lbs.	11 Cu Ft	\$ 2,554	

End, Mid, Top and Base Panels to be constructed from 1" thick 11-ply solid core, veneered 2 sides. Vertical, top and bottom edges banded with 1/4" external hardwood edging, edges to be eased.





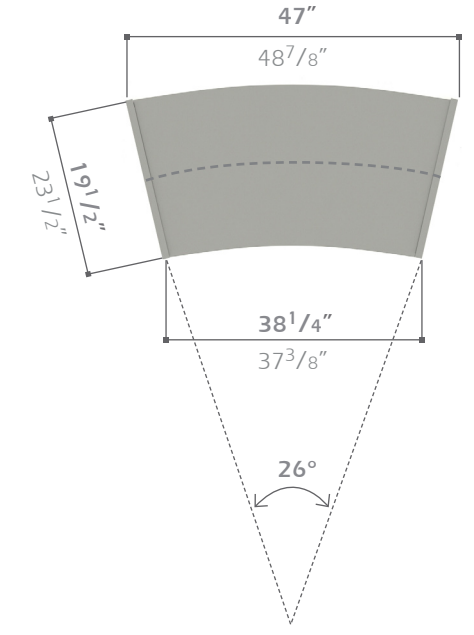

	MODEL NUMBER	PRODUCT	WIDTH	DEPTH	HEIGHT	SHELF DEPTH	# OF SHELVES	# OF OPENINGS	WEIGHT	VOLUME	LIST PRICE	DESCRIPTION
 <p>Model Shown DM-CV-3624-S-36-IPT</p>		26° Curved Shelving, Double Face										End, Mid, Top and Base Panels to be constructed from 1" thick 11-ply solid core, veneered 2 sides. Vertical, top and bottom edges banded with 1/4" external hardwood edging, edges to be eased.
	DM-CV-3620-S-36-IPT	Starter	47"	19 1/2"	36"		2	4	88.6 Lbs.	7 Cu Ft	\$ 3,244	
	DM-CV-3620-A-36-IPT	Adder	46"	19 1/2"	36"		2	4	73.6 Lbs.	6 Cu Ft	\$ 2,284	
	DM-CV-3624-S-36-IPT	Starter	48 7/8"	23 1/2"	36"		2	4	110 Lbs.	10 Cu Ft	\$ 3,312	
	DM-CV-3624-A-36-IPT	Adder	47 7/8"	23 1/2"	36"		2	4	95 Lbs.	9 Cu Ft	\$ 2,318	
 <p>Model Shown DM-CV-3624-A-36-IPT</p>		26° Curved Shelving, Double Face										
	DM-CV-4220-S-36-IPT	Starter	47"	19 1/2"	42"		4	6	94 Lbs.	7 Cu Ft	\$ 3,564	
	DM-CV-4220-A-36-IPT	Adder	46"	19 1/2"	42"		4	6	78 Lbs.	7 Cu Ft	\$ 2,601	
	DM-CV-4224-S-36-IPT	Starter	48 7/8"	23 1/2"	42"		4	6	115 Lbs.	10 Cu Ft	\$ 3,643	
	DM-CV-4224-A-36-IPT	Adder	47 7/8"	23 1/2"	42"		4	6	113 Lbs.	10 Cu Ft	\$ 2,647	
 <p>Model Shown DM-CV-4824-S-36-IPT</p>		26° Curved Shelving, Double Face										
	DM-CV-4820-S-36-IPT	Starter	47"	19 1/2"	48"		4	6	132 Lbs.	9 Cu Ft	\$ 3,689	
	DM-CV-4820-A-36-IPT	Adder	46"	19 1/2"	48"		4	6	109 Lbs.	8 Cu Ft	\$ 2,704	
	DM-CV-4824-S-36-IPT	Starter	48 7/8"	23 1/2"	48"		4	6	155 Lbs.	11 Cu Ft	\$ 3,778	
	DM-CV-4824-A-36-IPT	Adder	47 7/8"	23 1/2"	48"		4	6	127 Lbs.	10 Cu Ft	\$ 2,750	
 <p>Model Shown DM-CV-6024-S-36-IPT</p>		26° Curved Shelving, Double Face										
	DM-CV-6020-S-36-IPT	Starter	47"	19 1/2"	60"		6	8	176 Lbs.	11 Cu Ft	\$ 3,800	
	DM-CV-6020-A-36-IPT	Adder	46"	19 1/2"	60"		6	8	145 Lbs.	10 Cu Ft	\$ 2,786	
	DM-CV-6024-S-36-IPT	Starter	48 7/8"	23 1/2"	60"		6	8	200 Lbs.	12 Cu Ft	\$ 3,892	
	DM-CV-6024-A-36-IPT	Adder	47 7/8"	23 1/2"	60"		6	8	164 Lbs.	11 Cu Ft	\$ 2,769	







MODEL NUMBER	PRODUCT	WIDTH	DEPTH	HEIGHT	WEIGHT	VOLUME	LIST PRICE	DESCRIPTION	
 <p>Model Shown S-BA7212E</p>	S-BA3010E	Bolt Assembly	1"	10 <sup>1</sup> / <sub>8</sub> "	30"		\$ 529		
	S-BA3610E	Single Face End Panels	1"	10 <sup>1</sup> / <sub>8</sub> "	36"	7 Lbs.	0.3 Cu Ft	\$ 552	
	S-BA4210E		1"	10 <sup>1</sup> / <sub>8</sub> "	42"	8 Lbs.	0.3 Cu Ft	\$ 568	
	S-BA4810E		1"	10 <sup>1</sup> / <sub>8</sub> "	48"	9 Lbs.	0.3 Cu Ft	\$ 583	
	S-BA6010E		1"	10 <sup>1</sup> / <sub>8</sub> "	60"	12 Lbs.	0.4 Cu Ft	\$ 614	
	S-BA7210E		1"	10 <sup>1</sup> / <sub>8</sub> "	72"	14 Lbs.	0.5 Cu Ft	\$ 637	
	S-BA8210E		1"	10 <sup>1</sup> / <sub>8</sub> "	82"	16 Lbs.	0.6 Cu Ft	\$ 669	
	S-BA9610E		1"	10 <sup>1</sup> / <sub>8</sub> "	96"	19 Lbs.	0.7 Cu Ft	\$ 700	
	S-BA3012E	Bolt Assembly	1"	12 <sup>1</sup> / <sub>8</sub> "	30"			\$ 692	
	S-BA3612E	Single Face End Panels	1"	12 <sup>1</sup> / <sub>8</sub> "	36"	7 Lbs.	0.3 Cu Ft	\$ 731	
S-BA4212E		1"	12 <sup>1</sup> / <sub>8</sub> "	42"	8 Lbs.	0.3 Cu Ft	\$ 746		
S-BA4812E		1"	12 <sup>1</sup> / <sub>8</sub> "	48"	9 Lbs.	0.3 Cu Ft	\$ 622		
S-BA6012E		1"	12 <sup>1</sup> / <sub>8</sub> "	60"	12 Lbs.	0.4 Cu Ft	\$ 653		
S-BA7212E		1"	12 <sup>1</sup> / <sub>8</sub> "	72"	14 Lbs.	0.5 Cu Ft	\$ 684		
S-BA8212E		1"	12 <sup>1</sup> / <sub>8</sub> "	82"	16 Lbs.	0.6 Cu Ft	\$ 715		
S-BA9612E		1"	12 <sup>1</sup> / <sub>8</sub> "	96"	19 Lbs.	0.7 Cu Ft	\$ 746		
S-BA3014E	Bolt Assembly	1"	14 <sup>5</sup> / <sub>8</sub> "	30"			\$ 739		
S-BA3614E	Single Face End Panels	1"	14 <sup>5</sup> / <sub>8</sub> "	36"	7 Lbs.	0.3 Cu Ft	\$ 777		
S-BA4214E		1"	14 <sup>5</sup> / <sub>8</sub> "	42"	8 Lbs.	0.3 Cu Ft	\$ 793		
S-BA4814E		1"	14 <sup>5</sup> / <sub>8</sub> "	48"	9 Lbs.	0.3 Cu Ft	\$ 653		
S-BA6014E		1"	14 <sup>5</sup> / <sub>8</sub> "	60"	12 Lbs.	0.4 Cu Ft	\$ 684		
S-BA7214E		1"	14 <sup>5</sup> / <sub>8</sub> "	72"	14 Lbs.	0.5 Cu Ft	\$ 715		
S-BA8214E		1"	14 <sup>5</sup> / <sub>8</sub> "	82"	16 Lbs.	0.6 Cu Ft	\$ 746		
S-BA9614E		1"	14 <sup>5</sup> / <sub>8</sub> "	96"	19 Lbs.	0.7 Cu Ft	\$ 777		
S-BA3020E	Bolt Assembly	1"	19 <sup>1</sup> / <sub>2</sub> "	30"			\$ 910		
S-BA3620E	Double Face End Panels	1"	19 <sup>1</sup> / <sub>2</sub> "	36"	14 Lbs.	0.6 Cu Ft	\$ 957		
S-BA4220E		1"	19 <sup>1</sup> / <sub>2</sub> "	42"	15 Lbs.	0.6 Cu Ft	\$ 981		
S-BA4820E		1"	19 <sup>1</sup> / <sub>2</sub> "	48"	18 Lbs.	0.7 Cu Ft	\$ 1,011		
S-BA6020E		1"	19 <sup>1</sup> / <sub>2</sub> "	60"	24 Lbs.	0.8 Cu Ft	\$ 1,073		
S-BA7220E		1"	19 <sup>1</sup> / <sub>2</sub> "	72"	28 Lbs.	1 Cu Ft	\$ 1,127		
S-BA8220E		1"	19 <sup>1</sup> / <sub>2</sub> "	82"	32 Lbs.	1.2 Cu Ft	\$ 1,189		
S-BA9620E		1"	19 <sup>1</sup> / <sub>2</sub> "	96"	38 Lbs.	1.4 Cu Ft	\$ 1,229		
S-BA3024E	Bolt Assembly	1"	23 <sup>1</sup> / <sub>2</sub> "	30"			\$ 941		
S-BA3624E	Double Face End Panels	1"	23 <sup>1</sup> / <sub>2</sub> "	36"	14 Lbs.	0.6 Cu Ft	\$ 981		
S-BA4224E		1"	23 <sup>1</sup> / <sub>2</sub> "	42"	15 Lbs.	0.6 Cu Ft	\$ 1,011		
S-BA4824E		1"	23 <sup>1</sup> / <sub>2</sub> "	48"	18 Lbs.	0.7 Cu Ft	\$ 1,042		
S-BA6024E		1"	23 <sup>1</sup> / <sub>2</sub> "	60"	24 Lbs.	0.8 Cu Ft	\$ 1,095		
S-BA7224E		1"	23 <sup>1</sup> / <sub>2</sub> "	72"	28 Lbs.	1 Cu Ft	\$ 1,158		
S-BA8224E		1"	23 <sup>1</sup> / <sub>2</sub> "	82"	32 Lbs.	1.2 Cu Ft	\$ 1,220		
S-BA9624E		1"	23 <sup>1</sup> / <sub>2</sub> "	96"	38 Lbs.	1.4 Cu Ft	\$ 1,275		
S-BA3028E	Bolt Assembly	1"	28 <sup>1</sup> / <sub>2</sub> "	30"			\$ 1,027		
S-BA3628E	Double Face End Panels	1"	28 <sup>1</sup> / <sub>2</sub> "	36"	14 Lbs.	0.6 Cu Ft	\$ 1,073		
S-BA4228E		1"	28 <sup>1</sup> / <sub>2</sub> "	42"	15 Lbs.	0.6 Cu Ft	\$ 1,105		
S-BA4828E		1"	28 <sup>1</sup> / <sub>2</sub> "	48"	18 Lbs.	0.7 Cu Ft	\$ 1,158		
S-BA6028E		1"	28 <sup>1</sup> / <sub>2</sub> "	60"	24 Lbs.	0.8 Cu Ft	\$ 1,236		
S-BA7228E		1"	28 <sup>1</sup> / <sub>2</sub> "	72"	28 Lbs.	1 Cu Ft	\$ 1,336		
S-BA8228E		1"	28 <sup>1</sup> / <sub>2</sub> "	82"	32 Lbs.	1.2 Cu Ft	\$ 1,423		
S-BA9628E		1"	28 <sup>1</sup> / <sub>2</sub> "	96"	38 Lbs.	1.4 Cu Ft	\$ 1,687		



MODEL NUMBER	PRODUCT	WIDTH	DEPTH	HEIGHT	WEIGHT	VOLUME	LIST PRICE	DESCRIPTION
 <p>Model Shown S-BA7212M</p>	S-BA3010M	Bolt Assembly	1"	10 <sup>1</sup> / <sub>8</sub> "	30"		\$ 552	
	S-BA3610M	Single Face Mid Panels	1"	10 <sup>1</sup> / <sub>8</sub> "	36"	7 Lbs.	0.3 Cu Ft	\$ 583
	S-BA4210M		1"	10 <sup>1</sup> / <sub>8</sub> "	42"	8 Lbs.	0.3 Cu Ft	\$ 598
	S-BA4810M		1"	10 <sup>1</sup> / <sub>8</sub> "	48"	9 Lbs.	0.3 Cu Ft	\$ 614
	S-BA6010M		1"	10 <sup>1</sup> / <sub>8</sub> "	60"	12 Lbs.	0.4 Cu Ft	\$ 637
	S-BA7210M		1"	10 <sup>1</sup> / <sub>8</sub> "	72"	14 Lbs.	0.5 Cu Ft	\$ 669
	S-BA8210M		1"	10 <sup>1</sup> / <sub>8</sub> "	82"	16 Lbs.	0.6 Cu Ft	\$ 700
	S-BA9610M		1"	10 <sup>1</sup> / <sub>8</sub> "	96"	19 Lbs.	0.7 Cu Ft	\$ 731
	S-BA3012M	Bolt Assembly	1"	12 <sup>1</sup> / <sub>8</sub> "	30"			\$ 568
S-BA3612M	Single Face Mid Panels	1"	12 <sup>1</sup> / <sub>8</sub> "	36"	7 Lbs.	0.3 Cu Ft	\$ 598	
S-BA4212M		1"	12 <sup>1</sup> / <sub>8</sub> "	42"	8 Lbs.	0.3 Cu Ft	\$ 614	
S-BA4812M		1"	12 <sup>1</sup> / <sub>8</sub> "	48"	9 Lbs.	0.3 Cu Ft	\$ 622	
S-BA6012M		1"	12 <sup>1</sup> / <sub>8</sub> "	60"	12 Lbs.	0.4 Cu Ft	\$ 653	
S-BA7212M		1"	12 <sup>1</sup> / <sub>8</sub> "	72"	14 Lbs.	0.5 Cu Ft	\$ 684	
S-BA8212M		1"	12 <sup>1</sup> / <sub>8</sub> "	82"	16 Lbs.	0.6 Cu Ft	\$ 715	
S-BA9612M		1"	12 <sup>1</sup> / <sub>8</sub> "	96"	19 Lbs.	0.7 Cu Ft	\$ 746	
S-BA3014M	Bolt Assembly	1"	14 <sup>5</sup> / <sub>8</sub> "	30"			\$ 598	
S-BA3614M	Single Face Mid Panels	1"	14 <sup>5</sup> / <sub>8</sub> "	36"	7 Lbs.	0.3 Cu Ft	\$ 622	
S-BA4214M		1"	14 <sup>5</sup> / <sub>8</sub> "	42"	8 Lbs.	0.3 Cu Ft	\$ 676	
S-BA4814M		1"	14 <sup>5</sup> / <sub>8</sub> "	48"	9 Lbs.	0.3 Cu Ft	\$ 653	
S-BA6014M		1"	14 <sup>5</sup> / <sub>8</sub> "	60"	12 Lbs.	0.4 Cu Ft	\$ 684	
S-BA7214M		1"	14 <sup>5</sup> / <sub>8</sub> "	72"	14 Lbs.	0.5 Cu Ft	\$ 746	
S-BA8214M		1"	14 <sup>5</sup> / <sub>8</sub> "	82"	16 Lbs.	0.6 Cu Ft	\$ 777	
S-BA9614M		1"	14 <sup>5</sup> / <sub>8</sub> "	96"	19 Lbs.	0.7 Cu Ft	\$ 800	
S-BA3020M	Bolt Assembly	1"	19 <sup>1</sup> / <sub>2</sub> "	30"			\$ 941	
S-BA3620M	Double Face Mid Panels	1"	19 <sup>1</sup> / <sub>2</sub> "	36"	14 Lbs.	0.6 Cu Ft	\$ 981	
S-BA4220M		1"	19 <sup>1</sup> / <sub>2</sub> "	42"	15 Lbs.	0.6 Cu Ft	\$ 1,011	
S-BA4820M		1"	19 <sup>1</sup> / <sub>2</sub> "	48"	18 Lbs.	0.7 Cu Ft	\$ 1,042	
S-BA6020M		1"	19 <sup>1</sup> / <sub>2</sub> "	60"	24 Lbs.	0.8 Cu Ft	\$ 1,095	
S-BA7220M		1"	19 <sup>1</sup> / <sub>2</sub> "	72"	28 Lbs.	1 Cu Ft	\$ 1,158	
S-BA8220M		1"	19 <sup>1</sup> / <sub>2</sub> "	82"	32 Lbs.	1.2 Cu Ft	\$ 1,220	
S-BA9620M		1"	19 <sup>1</sup> / <sub>2</sub> "	96"	38 Lbs.	1.4 Cu Ft	\$ 1,275	
S-BA3024M	Bolt Assembly	1"	23 <sup>1</sup> / <sub>2</sub> "	30"			\$ 964	
S-BA3624M	Double Face Mid Panels	1"	23 <sup>1</sup> / <sub>2</sub> "	36"	14 Lbs.	0.6 Cu Ft	\$ 1,011	
S-BA4224M		1"	23 <sup>1</sup> / <sub>2</sub> "	42"	15 Lbs.	0.6 Cu Ft	\$ 1,042	
S-BA4824M		1"	23 <sup>1</sup> / <sub>2</sub> "	48"	18 Lbs.	0.7 Cu Ft	\$ 1,073	
S-BA6024M		1"	23 <sup>1</sup> / <sub>2</sub> "	60"	24 Lbs.	0.8 Cu Ft	\$ 1,127	
S-BA7224M		1"	23 <sup>1</sup> / <sub>2</sub> "	72"	28 Lbs.	1 Cu Ft	\$ 1,189	
S-BA8224M		1"	23 <sup>1</sup> / <sub>2</sub> "	82"	32 Lbs.	1.2 Cu Ft	\$ 1,244	
S-BA9624M		1"	23 <sup>1</sup> / <sub>2</sub> "	96"	38 Lbs.	1.4 Cu Ft	\$ 1,306	
S-BA3028M	Bolt Assembly	1"	28 <sup>1</sup> / <sub>2</sub> "	30"			\$ 1,049	
S-BA3628M	Double Face Mid Panels	1"	28 <sup>1</sup> / <sub>2</sub> "	36"	14 Lbs.	0.6 Cu Ft	\$ 1,095	
S-BA4228M		1"	28 <sup>1</sup> / <sub>2</sub> "	42"	15 Lbs.	0.6 Cu Ft	\$ 1,135	
S-BA4828M		1"	28 <sup>1</sup> / <sub>2</sub> "	48"	18 Lbs.	0.7 Cu Ft	\$ 1,189	
S-BA6028M		1"	28 <sup>1</sup> / <sub>2</sub> "	60"	24 Lbs.	0.8 Cu Ft	\$ 1,275	
S-BA7228M		1"	28 <sup>1</sup> / <sub>2</sub> "	72"	28 Lbs.	1 Cu Ft	\$ 1,369	
S-BA8228M		1"	28 <sup>1</sup> / <sub>2</sub> "	82"	32 Lbs.	1.2 Cu Ft	\$ 1,454	
S-BA9628M		1"	28 <sup>1</sup> / <sub>2</sub> "	96"	38 Lbs.	1.4 Cu Ft	\$ 1,547	

	MODEL NUMBER	PRODUCT	WIDTH	DEPTH	HEIGHT	WEIGHT	VOLUME	LIST PRICE	DESCRIPTION
	S-BAT1024	Bolt Assembly Single Face Top Shelf	23 1/4"	9 3/4"	2 1/2"	7 Lbs.	0.3 Cu Ft	\$ 536	
	S-BAT1224		23 1/4"	11 3/4"	2 1/2"			\$ 552	
	S-BAT1424		23 1/4"	14 1/4"	2 1/2"			\$ 568	
	S-BAT1030		29 1/4"	9 3/4"	2 1/2"			\$ 536	
	S-BAT1230		29 1/4"	11 3/4"	2 1/2"			\$ 552	
	S-BAT1430		29 1/4"	14 1/4"	2 1/2"			\$ 568	
	S-BAT1036		35 1/4"	9 3/4"	2 1/2"	7 Lbs	0.8 Cu Ft	\$ 452	
	S-BAT1236		35 1/4"	11 3/4"	2 1/2"	9 Lbs	0.8 Cu Ft	\$ 466	
	S-BAT1436		35 1/4"	14 1/4"	2 1/2"	10 Lbs	0.8 Cu Ft	\$ 483	
	S-BAT2024	Bolt Assembly Double Face Top Shelf	23 1/4"	19 1/4"	2 1/2"			\$ 770	
	S-BAT2424		23 1/4"	23 1/4"	2 1/2"			\$ 800	
	S-BAT2824		23 1/4"	28 1/4"	2 1/2"			\$ 839	
	S-BAT2030		29 1/4"	19 1/4"	2 1/2"			\$ 770	
	S-BAT2430		29 1/4"	23 1/4"	2 1/2"			\$ 800	
	S-BAT2830		29 1/4"	28 1/4"	2 1/2"			\$ 839	
	S-BAT2036		35 1/4"	19 1/4"	2 1/2"	14 Lbs	1.5 Cu Ft	\$ 637	
	S-BAT2436		35 1/4"	23 1/4"	2 1/2"	16 Lbs	1.5 Cu Ft	\$ 669	
	S-BAT2836		35 1/4"	28 1/4"	2 1/2"	18 Lbs	1.5 Cu Ft	\$ 715	
	S-BAB1024	Bolt Assembly Single Face Bottom Shelf	23 1/4"	9 3/4"	2 1/2"			\$ 560	
	S-BAB1224		23 1/4"	11 3/4"	2 1/2"			\$ 576	
	S-BAB1424		23 1/4"	14 1/4"	2 1/2"			\$ 590	
	S-BAB1030		29 1/4"	9 3/4"	2 1/2"			\$ 560	
	S-BAB1230		29 1/4"	11 3/4"	2 1/2"			\$ 576	
	S-BAB1430		29 1/4"	14 1/4"	2 1/2"			\$ 590	
	S-BAB1036		35 1/4"	9 3/4"	2 1/2"	7 Lbs	0.8 Cu Ft	\$ 466	
	S-BAB1236		35 1/4"	11 3/4"	2 1/2"	9 Lbs	0.8 Cu Ft	\$ 490	
	S-BAB1436		35 1/4"	14 1/4"	2 1/2"	10 Lbs	0.8 Cu Ft	\$ 505	
	S-BAB2024	Bolt Assembly Double Face Bottom Shelf	23 1/4"	19 1/4"	2 1/2"			\$ 810	
	S-BAB2424		23 1/4"	23 1/4"	2 1/2"			\$ 839	
	S-BAB2824		23 1/4"	28 1/4"	2 1/2"			\$ 877	
	S-BAB2030		29 1/4"	19 1/4"	2 1/2"			\$ 810	
	S-BAB2430		29 1/4"	23 1/4"	2 1/2"			\$ 839	
	S-BAB2830		29 1/4"	28 1/4"	2 1/2"			\$ 910	
	S-BAB2036		35 1/4"	19 1/4"	2 1/2"	14 Lbs	1.5 Cu Ft	\$ 669	
	S-BAB2436		35 1/4"	23 1/4"	2 1/2"	16 Lbs	1.5 Cu Ft	\$ 700	
	S-BAB2836		35 1/4"	28 1/4"	2 1/2"	18 Lbs	1.5 Cu Ft	\$ 746	

MODEL NUMBER	PRODUCT	WIDTH	DEPTH	HEIGHT	WEIGHT	VOLUME	LIST PRICE	DESCRIPTION
	S-PB30S-24	Printed Backs - Single Face	24"	30"			\$ 78	
	S-PB30S-30		30"	30"			\$ 78	
	S-PB30S-36		36"	30"			\$ 86	
	S-PB36S-24		24"	36"	9 Lbs.	0.2 Cu Ft	\$ 78	
	S-PB36S-30		30"	36"			\$ 78	
	S-PB36S-36		36"	36"			\$ 86	
	S-PB42S-24		24"	42"			\$ 78	
	S-PB42S-30		30"	42"			\$ 78	
	S-PB42S-36		36"	42"	9 Lbs.	0.2 Cu Ft	\$ 86	
	S-PB48S-24		24"	48"			\$ 78	
	S-PB48S-30		30"	48"			\$ 78	
	S-PB48S-36		36"	48"	12 Lbs.	0.3 Cu Ft	\$ 86	
	S-PB60S-24		24"	60"			\$ 93	
	S-PB60S-30		30"	60"			\$ 110	
	S-PB60S-36		36"	60"	15 Lbs.	0.3 Cu Ft	\$ 110	
	S-PB72S-24		24"	72"			\$ 131	
	S-PB72S-30		30"	72"			\$ 131	
	S-PB72S-36		36"	72"	18 Lbs.	0.4 Cu Ft	\$ 131	
	S-PB84S-24		24"	82"			\$ 131	
	S-PB84S-30		30"	82"			\$ 131	
	S-PB84S-36		36"	82"	21 Lbs.	0.4 Cu Ft	\$ 131	
	S-PB96S-24		24"	96"			\$ 131	
	S-PB96S-30		30"	96"			\$ 131	
	S-PB96S-36		36"	96"	24 Lbs.	0.5 Cu Ft	\$ 131	

Model Shown  
S-PB72D-24

MODEL NUMBER	PRODUCT	WIDTH	DEPTH	HEIGHT	WEIGHT	VOLUME	LIST PRICE	DESCRIPTION
	S-PB30D-24	Printed Backs - Double Face	24"	30"			\$ 93	
	S-PB30D-30		30"	30"			\$ 93	
	S-PB30D-36		36"	30"			\$ 93	
	S-PB36D-24		24"	36"	9 Lbs.	0.2 Cu Ft	\$ 93	
	S-PB36D-30		30"	36"			\$ 93	
	S-PB36D-36		36"	36"			\$ 93	
	S-PB42D-24		24"	42"	9 Lbs.	0.2 Cu Ft	\$ 93	
	S-PB42D-30		30"	42"			\$ 93	
	S-PB42D-36		36"	42"			\$ 93	
Model Shown S-PB72D-24	S-PB48D-24		24"	48"	12 Lbs.	0.3 Cu Ft	\$ 93	
	S-PB48D-30		30"	48"			\$ 93	
	S-PB48D-36		36"	48"			\$ 93	
	S-PB60D-24		24"	60"	15 Lbs.	0.3 Cu Ft	\$ 148	
	S-PB60D-30		30"	60"			\$ 148	
	S-PB60D-36		36"	60"			\$ 148	
	S-PB72D-24		24"	72"	18 Lbs.	0.4 Cu Ft	\$ 148	
	S-PB72D-30		30"	72"			\$ 148	
	S-PB72D-36		36"	72"			\$ 148	
	S-PB84D-24		24"	82"	21 Lbs.	0.4 Cu Ft	\$ 148	
	S-PB84D-30		30"	82"			\$ 148	
	S-PB84D-36		36"	82"			\$ 148	
	S-PB96D-24		24"	96"	24 Lbs.	0.5 Cu Ft	\$ 148	
	S-PB96D-30		30"	96"			\$ 148	
	S-PB96D-36		36"	96"			\$ 148	

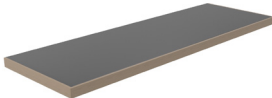
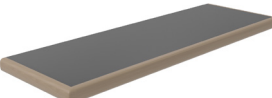
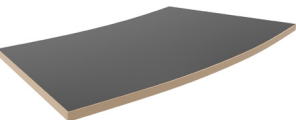
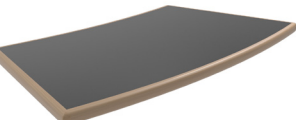
MODEL NUMBER	PRODUCT	WIDTH	DEPTH	HEIGHT	WEIGHT	VOLUME	LIST PRICE	DESCRIPTION	
 <p>Model Shown S-PLSS-3612</p>	S-PLSS-2410	Sloped Continuous Plastic	24"	9 <sup>3</sup> / <sub>4</sub> "	7"	45 Lbs.	0.6 Cu Ft	\$ 560	
	S-PLSS-2412	Laminate Top, Single Face	24"	11 <sup>3</sup> / <sub>4</sub> "	7"			\$ 576	
	S-PLSS-2414		24"	14 <sup>1</sup> / <sub>4</sub> "	7"			\$ 590	
	S-PLSS-3010		30"	9 <sup>3</sup> / <sub>4</sub> "	7"			\$ 560	
	S-PLSS-3012		30"	11 <sup>3</sup> / <sub>4</sub> "	7"			\$ 576	
	S-PLSS-3014		30"	14 <sup>1</sup> / <sub>4</sub> "	7"			\$ 590	
	S-PLSS-3610		36"	9 <sup>3</sup> / <sub>4</sub> "	7"			\$ 474	
	S-PLSS-3612		36"	11 <sup>3</sup> / <sub>4</sub> "	7"			\$ 490	
	S-PLSS-3614		36"	14 <sup>1</sup> / <sub>4</sub> "	7"			\$ 498	
	 <p>Model Shown S-PLSD-3624</p>	S-PLSD-2420	Sloped Continuous Plastic	24"	19 <sup>1</sup> / <sub>4</sub> "	7"	75 Lbs.	17 Cu Ft	\$ 762
		S-PLSD-2424	Laminate Top, Double Face	24"	23 <sup>1</sup> / <sub>4</sub> "	7"			\$ 785
		S-PLSD-2428		24"	28 <sup>1</sup> / <sub>4</sub> "	7"			\$ 810
S-PLSD-3020			30"	19 <sup>1</sup> / <sub>4</sub> "	7"			\$ 762	
S-PLSD-3024			30"	23 <sup>1</sup> / <sub>4</sub> "	7"			\$ 785	
S-PLSD-3028			30"	28 <sup>1</sup> / <sub>4</sub> "	7"			\$ 810	
S-PLSD-3620			36"	19 <sup>1</sup> / <sub>4</sub> "	7"			\$ 676	
S-PLSD-3624			36"	23 <sup>1</sup> / <sub>4</sub> "	7"			\$ 700	
S-PLSD-3628			36"	28 <sup>1</sup> / <sub>4</sub> "	7"			\$ 715	
 <p>Model Shown S-CT36S-B</p>	Continuous Top, Square Edge (Beta)								
	S-CT36S-B	Single Face	36"	12"	1"	30 Lbs.	0.4 Cu Ft	\$ 256	
 <p>Model Shown S-CT36S-R</p>	Continuous Top, Bullnose Edge (Ronda)								
	S-CT36S-R	Single Face	36"	12"	1"	30 Lbs.	0.4 Cu Ft	\$ 436	
 <p>Model Shown S-CV36-20-B</p>	Continuous Curved Top (Beta)								
	S-CV36-20-B	Double Face, 20" D	36"	20"	1"	60 Lbs.	0.7 Cu Ft	\$ 475	
 <p>Model Shown S-CV36-20-R</p>	Continuous Curved Top (Ronda)								
	S-CV36-20-R	Double Face, 20" D	36"	20"	1"	60 Lbs.	0.7 Cu Ft	\$ 614	
	S-CV36-24-R	Double Face, 24" D	36"	24"	1"	60 Lbs.	0.7 Cu Ft	\$ 633	

Sloped Top option is only available for Shelving units with a height of 36", 42", or 48"

Note: With this option the overall height of the unit will increase;

36" increases to 43"  
42" increases to 49"  
48" increases to 55"

Single faced tops shall receive edges on 2 short and 1 long edge. Double faced tops shall receive edges on 2 long and 2 short edges. Tops longer than 108" shall be joined together using tight joint fasteners. Suitable for shelving up to 60" high.

Prices are given per individual bay. Multiply the list price by the number of bay lengths required.

	MODEL NUMBER	PRODUCT	WIDTH	DEPTH	HEIGHT	WEIGHT	VOLUME	LIST PRICE	DESCRIPTION
 <p>Model Shown S-VB72D-24</p>	S-VB30S-24	Veneer Backs - Single Face	24"		30"			\$ 178	
	S-VB30S-30		30"		30"			\$ 178	
	S-VB30S-36		36"		30"			\$ 178	
	S-VB36S-24		24"		36"	9 Lbs.	0.2 Cu Ft	\$ 178	
	S-VB36S-30		30"		36"			\$ 178	
	S-VB36S-36		36"		36"			\$ 178	
	S-VB42S-24		24"		42"			\$ 178	
	S-VB42S-30		30"		42"			\$ 178	
	S-VB42S-36		36"		42"	9 Lbs.	0.2 Cu Ft	\$ 178	
	S-VB48S-24		24"		48"			\$ 178	
	S-VB48S-30		30"		48"			\$ 178	
	S-VB48S-36		36"		48"	12 Lbs.	0.3 Cu Ft	\$ 178	
	S-VB60S-24		24"		60"			\$ 273	
	S-VB60S-30		30"		60"			\$ 273	
	S-VB60S-36		36"		60"	15 Lbs.	0.3 Cu Ft	\$ 273	
	S-VB72S-24		24"		72"			\$ 273	
	S-VB72S-30		30"		72"			\$ 273	
	S-VB72S-36		36"		72"	18 Lbs.	0.4 Cu Ft	\$ 273	
S-VB82S-24		24"		82"			\$ 273		
S-VB82S-30		30"		82"			\$ 273		
S-VB82S-36		36"		82"	21 Lbs.	0.4 Cu Ft	\$ 273		
S-VB96S-24		24"		96"			\$ 273		
S-VB96S-30		30"		96"			\$ 273		
S-VB96S-36		36"		96"	24 Lbs.	0.5 Cu Ft	\$ 273		

MODEL NUMBER	PRODUCT	WIDTH	DEPTH	HEIGHT	WEIGHT	VOLUME	LIST PRICE	DESCRIPTION
	S-VB30D-24	Veneer Backs - Double Face	24"	30"			\$ 273	
	S-VB30D-30		30"	30"			\$ 273	
	S-VB30D-36		36"	30"			\$ 273	
	S-VB36D-24		24"	36"	9 Lbs.	0.2 Cu Ft	\$ 273	
	S-VB36D-30		30"	36"			\$ 273	
	S-VB36D-36		36"	36"			\$ 273	
	S-VB42D-24		24"	42"			\$ 273	
	S-VB42D-30		30"	42"			\$ 273	
	S-VB42D-36		36"	42"	9 Lbs.	0.2 Cu Ft	\$ 273	
	S-VB48D-24		24"	48"			\$ 273	
	S-VB48D-30		30"	48"			\$ 273	
	S-VB48D-36		36"	48"	12 Lbs.	0.3 Cu Ft	\$ 273	
	S-VB60D-24		24"	60"			\$ 397	
	S-VB60D-30		30"	60"			\$ 397	
	S-VB60D-36		36"	60"	15 Lbs.	0.3 Cu Ft	\$ 397	
	S-VB72D-24		24"	72"			\$ 397	
	S-VB72D-30		30"	72"			\$ 397	
	S-VB72D-36		36"	72"	18 Lbs.	0.4 Cu Ft	\$ 397	
	S-VB82D-24		24"	82"			\$ 397	
	S-VB82D-30		30"	82"			\$ 397	
	S-VB82D-36		36"	82"	21 Lbs.	0.4 Cu Ft	\$ 397	
	S-VB96D-24		24"	96"			\$ 397	
	S-VB96D-30		30"	96"			\$ 397	
	S-VB96D-36		36"	96"	24 Lbs.	0.5 Cu Ft	\$ 397	

Model Shown  
S-VB72D-24



MODEL NUMBER	PRODUCT	WIDTH	DEPTH	HEIGHT	WEIGHT	VOLUME	LIST PRICE	DESCRIPTION
	S-FB-V-30-24	Finished Back Veneer Option	24"	30"			\$ 568	
	S-FB-V-30-30		30"	30"			\$ 568	
	S-FB-V-30-36		36"	30"			\$ 568	
	S-FB-V-36-24		24"	36"	9 Lbs.	0.2 Cu Ft	\$ 568	
	S-FB-V-36-30		30"	36"			\$ 568	
	S-FB-V-36-36		36"	36"			\$ 568	
	S-FB-V-42-24		24"	42"			\$ 568	
	S-FB-V-42-30		30"	42"			\$ 568	
	S-FB-V-42-36		36"	42"	9 Lbs.	0.2 Cu Ft	\$ 568	
	S-FB-V-48-24		24"	48"			\$ 568	
	S-FB-V-48-30		30"	48"			\$ 568	
	S-FB-V-48-36		36"	48"	12 Lbs.	0.3 Cu Ft	\$ 568	
	S-FB-V-60-24		24"	60"			\$ 715	
	S-FB-V-60-30		30"	60"			\$ 715	
	S-FB-V-60-36		36"	60"	15 Lbs.	0.3 Cu Ft	\$ 715	
	S-FB-V-72-24		24"	72"			\$ 715	
	S-FB-V-72-30		30"	72"			\$ 715	
	S-FB-V-72-36		36"	72"	18 Lbs.	0.4 Cu Ft	\$ 715	
	S-FB-V-82-24		24"	82"			\$ 715	
	S-FB-V-82-30		30"	82"			\$ 715	
	S-FB-V-82-36		36"	82"	21 Lbs.	0.4 Cu Ft	\$ 715	
	S-FB-V-96-24		24"	96"			\$ 715	
	S-FB-V-96-30		30"	96"			\$ 715	
	S-FB-V-96-36		36"	96"	24 Lbs.	0.5 Cu Ft	\$ 715	





Model Shown  
S-FB-V-72-24



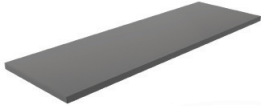
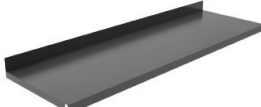

MODEL NUMBER	PRODUCT	WIDTH	DEPTH	HEIGHT	WEIGHT	VOLUME	LIST PRICE	DESCRIPTION
	S-FB-C-30-24	Finished Back Cork Option	24"	30"			\$ 831	
	S-FB-C-30-30		30"	30"			\$ 831	
	S-FB-C-30-36		36"	30"			\$ 831	
	S-FB-C-36-24		24"	36"	9 Lbs.	0.2 Cu Ft	\$ 831	
	S-FB-C-36-30		30"	36"			\$ 831	
	S-FB-C-36-36		36"	36"			\$ 831	
	S-FB-C-42-24		24"	42"	9 Lbs.	0.2 Cu Ft	\$ 831	
	S-FB-C-42-30		30"	42"			\$ 831	
	S-FB-C-42-36		36"	42"			\$ 831	
Model Shown S-FB-C-72-24	S-FB-C-48-24		24"	48"	12 Lbs.	0.3 Cu Ft	\$ 831	
	S-FB-C-48-30		30"	48"			\$ 831	
	S-FB-C-48-36		36"	48"			\$ 831	
	S-FB-C-60-24		24"	60"	15 Lbs.	0.3 Cu Ft	\$ 1,182	
	S-FB-C-60-30		30"	60"			\$ 1,182	
	S-FB-C-60-36		36"	60"			\$ 1,182	
	S-FB-C-72-24		24"	72"	18 Lbs.	0.4 Cu Ft	\$ 1,182	
	S-FB-C-72-30		30"	72"			\$ 1,182	
	S-FB-C-72-36		36"	72"			\$ 1,182	
	S-FB-C-82-24		24"	82"	21 Lbs.	0.4 Cu Ft	\$ 1,182	
	S-FB-C-82-30		30"	82"			\$ 1,182	
	S-FB-C-82-36		36"	82"			\$ 1,182	
	S-FB-C-96-24		24"	96"	24 Lbs.	0.5 Cu Ft	\$ 1,182	
	S-FB-C-96-30		30"	96"			\$ 1,182	
	S-FB-C-96-36		36"	96"			\$ 1,182	



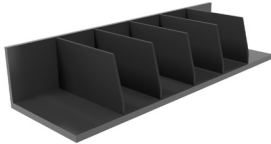
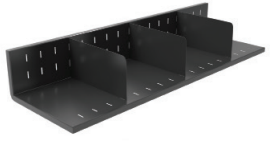
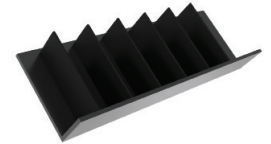

MODEL NUMBER	PRODUCT	WIDTH	DEPTH	HEIGHT	WEIGHT	VOLUME	LIST PRICE	DESCRIPTION
S-FB-S-30-24 S-FB-S-30-30 S-FB-S-30-36	Finished Back Slotwall Option	24"		30"			\$ 1,011	
		30"		30"			\$ 1,011	
		36"		30"			\$ 1,011	
S-FB-S-36-24 S-FB-S-36-30 S-FB-S-36-36		24"		36"	9 Lbs.	0.2 Cu Ft	\$ 1,011	
		30"		36"			\$ 1,011	
		36"		36"			\$ 1,011	
S-FB-S-42-24 S-FB-S-42-30 S-FB-S-42-36		24"		42"	9 Lbs.	0.2 Cu Ft	\$ 1,011	
		30"		42"			\$ 1,011	
		36"		42"			\$ 1,011	
S-FB-S-48-24 S-FB-S-48-30 S-FB-S-48-36		24"		48"	12 Lbs.	0.3 Cu Ft	\$ 1,011	
		30"		48"			\$ 1,011	
		36"		48"			\$ 1,011	
S-FB-S-60-24 S-FB-S-60-30 S-FB-S-60-36		24"		60"	15 Lbs.	0.3 Cu Ft	\$ 1,602	
		30"		60"			\$ 1,602	
		36"		60"			\$ 1,602	
S-FB-S-72-24 S-FB-S-72-30 S-FB-S-72-36		24"		72"	18 Lbs.	0.4 Cu Ft	\$ 1,602	
		30"		72"			\$ 1,602	
		36"		72"			\$ 1,602	
S-FB-S-82-24 S-FB-S-82-30 S-FB-S-82-36		24"		82"	21 Lbs.	0.4 Cu Ft	\$ 1,602	
		30"		82"			\$ 1,602	
		36"		82"			\$ 1,602	
S-FB-S-96-24 S-FB-S-96-30 S-FB-S-96-36		24"		96"	24 Lbs.	0.5 Cu Ft	\$ 1,602	
		30"		96"			\$ 1,602	
		36"		96"			\$ 1,602	











Model Shown  
S-FB-S-72-24

	MODEL NUMBER	PRODUCT	WIDTH	DEPTH	HEIGHT	WEIGHT	VOLUME	LIST PRICE	DESCRIPTION
 Model Shown M-F12-36	M-F10-24	Flat Metal Shelf	23 <sup>1</sup> / <sub>4</sub> "	9 <sup>1</sup> / <sub>2</sub> "	3 <sup>3</sup> / <sub>4</sub> "			\$ 86	Metal shelf with no book stop back edge.
	M-F12-24		23 <sup>1</sup> / <sub>4</sub> "	11 <sup>1</sup> / <sub>2</sub> "	3 <sup>3</sup> / <sub>4</sub> "			\$ 86	
	M-F10-30		29 <sup>1</sup> / <sub>4</sub> "	9 <sup>1</sup> / <sub>2</sub> "	3 <sup>3</sup> / <sub>4</sub> "			\$ 86	
	M-F12-30		29 <sup>1</sup> / <sub>4</sub> "	11 <sup>1</sup> / <sub>2</sub> "	3 <sup>3</sup> / <sub>4</sub> "			\$ 86	
	M-F10-36		35 <sup>1</sup> / <sub>4</sub> "	9 <sup>1</sup> / <sub>2</sub> "	3 <sup>3</sup> / <sub>4</sub> "	5 Lbs.	0.2 Cu Ft	\$ 86	
	M-F12-36		35 <sup>1</sup> / <sub>4</sub> "	11 <sup>1</sup> / <sub>2</sub> "	3 <sup>3</sup> / <sub>4</sub> "	6 Lbs.	0.2 Cu Ft	\$ 93	
 Model Shown M-LB12-36	M-LB10-24	Low Back Metal Shelf	23 <sup>1</sup> / <sub>4</sub> "	9 <sup>1</sup> / <sub>2</sub> "	1 <sup>3</sup> / <sub>4</sub> "			\$ 86	Metal shelf with a 1 <sup>1</sup> / <sub>4</sub> " high book stop back edge.
	M-LB12-24		23 <sup>1</sup> / <sub>4</sub> "	11 <sup>1</sup> / <sub>2</sub> "	1 <sup>3</sup> / <sub>4</sub> "			\$ 93	
	M-LB10-30		29 <sup>1</sup> / <sub>4</sub> "	9 <sup>1</sup> / <sub>2</sub> "	1 <sup>3</sup> / <sub>4</sub> "			\$ 86	
	M-LB12-30		29 <sup>1</sup> / <sub>4</sub> "	11 <sup>1</sup> / <sub>2</sub> "	1 <sup>3</sup> / <sub>4</sub> "			\$ 93	
	M-LB10-36		35 <sup>1</sup> / <sub>4</sub> "	9 <sup>1</sup> / <sub>2</sub> "	1 <sup>3</sup> / <sub>4</sub> "	5 Lbs.	0.2 Cu Ft	\$ 93	
	M-LB12-36		35 <sup>1</sup> / <sub>4</sub> "	11 <sup>1</sup> / <sub>2</sub> "	1 <sup>3</sup> / <sub>4</sub> "	6 Lbs.	0.2 Cu Ft	\$ 100	
 Model Shown M-M12-36	M-M12-24	Metal Magazine Shelf	23 <sup>1</sup> / <sub>4</sub> "	1"	12"	8 Lbs.	0.2 Cu Ft	\$ 155	Hinged metal magazine shelf with 12" height and 1" deep x 3 <sup>3</sup> / <sub>4</sub> " high lip. Includes two side brackets for installation.
	M-M12-30		29 <sup>1</sup> / <sub>4</sub> "	1"	12"			\$ 155	
	M-M12-36		35 <sup>1</sup> / <sub>4</sub> "	1"	12"			\$ 155	
 Model Shown M-C12-IN-36	M-C10-IN-36	26° Curved Metal Inside Shelf	40 <sup>1</sup> / <sub>4</sub> "	9 <sup>1</sup> / <sub>2</sub> "	3 <sup>3</sup> / <sub>4</sub> "			\$ 251	Curved metal shelf without shop back edge.
	M-C12-IN-36		40 <sup>1</sup> / <sub>4</sub> "	11 <sup>1</sup> / <sub>2</sub> "	3 <sup>3</sup> / <sub>4</sub> "			\$ 248	
 Model Shown M-C12-OT-36	M-C10-OT-36	26° Curved Metal Outside Shelf	44 <sup>3</sup> / <sub>4</sub> "	9 <sup>1</sup> / <sub>2</sub> "	3 <sup>3</sup> / <sub>4</sub> "			\$ 251	
	M-C12-OT-36		45 <sup>1</sup> / <sub>2</sub> "	11 <sup>1</sup> / <sub>2</sub> "	3 <sup>3</sup> / <sub>4</sub> "			\$ 248	

	MODEL NUMBER	PRODUCT	WIDTH	DEPTH	HEIGHT	WEIGHT	VOLUME	LIST PRICE	DESCRIPTION
 <p>Model Shown M-SL12-36</p>	M-SL12-24	Metal Picture Book Shelf	23 1/4"	11 1/2"	4 3/4"	9 Lbs.	1 Cu Ft	\$ 304	18 gauge cold rolled steel with flanges. Front of shelf bent to 90 degrees, 4" high above the shelf. Back flange forms a triple bend End flanges notched to accept 3/16" galvanized shelf support pin.
	M-SL12-30		29 1/4"	11 1/2"	4 3/4"			\$ 304	
	M-SL12-36		35 1/4"	11 1/2"	4 3/4"			\$ 312	
 <p>Model Shown SL12-36</p>	SL12-24	Slotted Metal Shelf	23 1/4"	11 1/2"	4 3/4"			\$ 248	Divider shelf is 5" high with 3 metal dividers. Shelf is slotted at 2" intervals.
	SL12-30		29 1/4"	11 1/2"	4 3/4"			\$ 248	
	SL12-36		35 1/4"	11 1/2"	4 3/4"			\$ 273	
 <p>Model Shown M-ME12-36</p>	M-ME12-24	Metal Media Shelf	23 1/4"	4 3/4"	12	15 Lbs.	1 Cu Ft	\$ 260	
	M-ME12-30		29 1/4"	4 3/4"	12			\$ 271	
	M-ME12-36		35 1/4"	4 3/4"	12			\$ 284	
 <p>Model Shown S-SWS32</p>	S-SWS08	Slot Wall Display Shelves	8"	3 1/2"	5 1/2"	1 Lbs.	0.1 Cu Ft	\$ 86	Clear acrylic u-shaped literature holder.
	S-SWS16		16"	3 1/2"	5 1/2"	1.5 Lbs.	0.1 Cu Ft	\$ 152	
	S-SWS32		32"	3 1/2"	5 1/2"	2.5 Lbs.	0.1 Cu Ft	\$ 282	
	M-GSB-1024	Bottom Metal Grooved Shelf Option	23 1/4"	9 1/2"	3 3/8"			\$ 54	Grooved metal shelf to accept pendant dividers. Upcharge is applicable. Notes: Each shelf comes with one pendant divider. Additional pendants can be ordered separately.
	M-GSB-1224		23 1/4"	11 1/2"	3 3/8"			\$ 54	
	M-GSB-1030	29 1/4"	9 1/2"	3 3/8"	\$ 54				
	M-GSB-1230	29 1/4"	11 1/2"	3 3/8"	\$ 54				
	M-GSB-1036	35 1/4"	9 1/2"	3 3/8"	\$ 54				
M-GSB-1236	35 1/4"	11 1/2"	3 3/8"	\$ 54					
	PD-01	Wire Pendant Divider						\$ 24	Wire pendant divider: chrome finish.

	MODEL NUMBER	PRODUCT	WIDTH	DEPTH	HEIGHT	WEIGHT	VOLUME	LIST PRICE	DESCRIPTION
	S-FPS	Top Filler Panel, Single Face				2 Lbs.	0.1 Cu Ft	\$ 202	
	S-FPD	Top Filler Panel, Double Face				4 Lbs.	0.1 Cu Ft	\$ 335	
	S-FPT	Top Filler Panel, Tristar				5 Lbs.	0.1 Cu Ft	\$ 452	
	S-FPF	Front Filler Panel				5 Lbs.	0.1 Cu Ft	\$ 483	

	MODEL NUMBER	PRODUCT	WIDTH	DEPTH	HEIGHT	WEIGHT	VOLUME	LIST PRICE	DESCRIPTION
	S-MS3624	Mobile Shelving Bottom Frame (Max 60" H Shelving)	36"	24"				\$ 590	
	S-MSC3624	Mobile Shelving Curved Bottom Frame (Max 60" H Shelving)	36"	24"	4 <sup>3</sup> / <sub>4</sub> "			\$ 864	
	S-SB	Sway Brace	60"					\$ 140	

	MODEL NUMBER	PRODUCT	WIDTH	DEPTH	HEIGHT	WEIGHT	VOLUME	LIST PRICE	DESCRIPTION
 <p>Model Shown DM-BE6</p>	M-BE6	Metal Book End	5"	5"	6"	0.8 Lbs.	0.1 Cu Ft	\$ 24	
	M-BE9		5"	5"	9"	1 Lbs.	0.1 Cu Ft	\$ 31	
	S-H35	Hanging Kick Bag Rod	35 1/4"	3/8"	3/8"	6 Lbs.	0.1 Cu Ft	\$ 241	
	S-140	Wall Mounted Newspaper Rack	35 1/4"	12"	30 1/2"	40 Lbs.	9 Cu Ft	\$ 949	
	G-NS	Newspaper Stick	34"	3/4"		0.5 Lbs.	0.1 Cu Ft	\$ 110	
	M-SP-24	24" Metal Media Spacer	23 1/4"	3 1/2"	4 1/2"			\$ 48	Metal media spacers are utilized to reduce shelf space depth in order to accompany various medias such as paperbacks or DVDs. Universally, the spacer can reduce the shelf depth by either 3 1/2" or 4 1/2" in dimension.
	M-SP-30	30" Metal Media Spacer	29 1/4"	3 1/2"	4 1/2"			\$ 48	
	M-SP-36	36" Metal Media Spacer	35 1/4"	3 1/2"	4 1/2"			\$ 44	

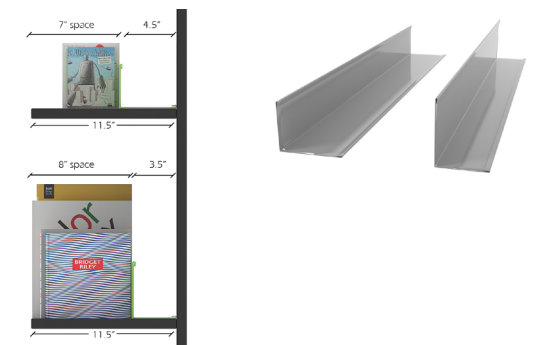



Palmieri Furniture Limited ("Palmieri") warrants that its products and collections are free from defects in materials and workmanship for the life of the product, except as set forth below. Palmieri Limited Lifetime Warranty is valid from the date of delivery.

**Exceptions to the Limited Lifetime Warranty: Seating: two (2) years**

Goods sold hereunder are covered by a Limited Lifetime Warranty, free against defects in material and workmanship provided the goods and services are subjected to normal use and service. The applicable warranty period commences from shipping date to Purchaser of any item of the goods, whichever occurs first, or any other warranty period otherwise stipulated in writing by Palmieri under this sale. For components not supplied by Palmieri, the original manufacturer's warranty shall apply to the extent assignable by Palmieri. The obligation under this warranty is limited to the repair or replacement, at Palmieri's option, of defective parts F.O.B. point of shipment provided that prompt notice of any defect is given by Purchaser to Palmieri in writing within the applicable warranty period and that upon the Purchaser's return of the defective parts to Palmieri or, if designated by Palmieri, to the location where the works are made, properly packed and with transportation charges prepaid by Purchaser, an inspection thereof shall reveal to Palmieri's satisfaction that Purchaser's claim is valid under the terms of this warranty. Purchaser shall assume all responsibility and expense for dismantling, removal, re-installation and freight in connection with the foregoing. The same obligations and conditions extend to replacement parts furnished by Palmieri hereunder.

Palmieri does not assume liability for installation, labour or consequential damages. Palmieri makes no warranty other than the one set forth herein. All other warranties, legal, expressed or implied, including but not limited to any expressed or implied warranty of merchantability, of fitness for the intended use thereof or against infringement are hereby expressly excluded. The applicable warranty ceases to be effective if the goods are altered or repaired other than by persons authorized or approved by Palmieri to perform such work. Repairs or replacement deliveries do not interrupt or prolong the term of the warranty. The warranty ceases to be effective if Purchaser fails to handle and use the goods sold hereunder in a safe and reasonable manner and in accordance with any written instructions from the manufacturers.

**Warranty Does Not Apply To Product Failure Or Loss Resulting From:**

Abuse, misuse or accident, alteration or modification of product by customer or third party, normal wear and tear, improper installation, handling or incorrect use. The substitution of part components or hardware not approved or authorized by Palmieri, acts of God, unauthorized repairs, improper storage, and environmental conditions such as irregular temperature control either inside or outside the environment.

**Warranty Provides Exclusive Remedies:**

If a product fails under ordinary use as a result of a defect in material or workmanship, Palmieri will: (A) repair, or (B) replace the furniture. The replacement or repair of the Furniture or Seating will be at the discretion of Palmieri. If the defect or workmanship cannot be remedied on site, repairs can be made at the factory. (C) If the product repair or replacement is not commercially practicable or cannot be remade in a timely manner Palmieri will refund the purchase price of the affected product. A product "Defect" means: an inadequacy in the materials or workmanship of the product that (A) existed at the time when you received the product from Palmieri or Palmieri authorized Reseller and (B) causes a failure of the product to perform under ordinary use in accordance with the materials and documentation accompanying the product. "Ordinary Use" means: use of the product (A) in accordance with all applicable local, state or federal laws, codes and regulations and (B) in accordance with manufacturer recommendations and or instructions in the materials and documentation accompanying the product or through shop drawings. A "Palmieri Authorized Reseller" means: any dealer that is legally permitted to conduct business in the jurisdiction where the product is sold and is duly authorized by Palmieri to sell the product.

Warranty work must be approved by authorized personnel of Palmieri Furniture Limited in Richmond Hill, Ontario, Canada.

**A copy of the original purchase order must accompany all claims.**

**Warranty Does Not Cover:**

Matching of colours, stains, textures, grains and any other variations in materials. Select and Custom Surfaces and materials are only warranted for their application on the specified product and are not covered by our warranty, except as warranted by the original supplier, for quality, colorfastness, shade variations or abrasion and textiles purchased for Palmieri product.

**This limited warranty is the sole remedy for product defect and no other express or implied warranty is provided. Warranty is not transferable and valid only for the original purchaser acquiring a product from Palmieri or a Palmieri authorized reseller for the purchaser's own use and not for resale, remarketing or distribution. Limited Lifetime Warranty (25 years)**

**GENERAL**

The following Terms and Conditions of Quote and Sale shall apply to any sale of goods and services by Palmieri Furniture Limited (hereinafter called "Palmieri"). Purchaser shall be deemed to have full knowledge of the terms and conditions herein and such terms and conditions shall be binding if either the goods and services referred to herein are delivered to and accepted by Purchaser, or if Purchaser does not within five (5) days from the date hereof deliver to Palmieri written objection to said terms and conditions or any part thereof.

In the event of any conflict or inconsistency between the terms and conditions of sale herein and the terms and conditions contained in Purchaser's order or in any other form issued by Purchaser, whether or not any such form has been acknowledged or accepted by Palmieri, Palmieri's terms and conditions herein shall prevail. No waiver, alteration or modification of these terms and conditions shall be binding upon Palmieri unless made in writing and signed by a duly authorized representative of Palmieri.

**1. QUOTATIONS / PRODUCT QUOTED**

Unless otherwise stated, **Palmieri's quotations shall be null and void unless accepted by Purchaser within thirty (30) days from the date of quotation.** Quotes may be subject to change before order placement, due to increased material costs and or other factors that could impact the final cost of production and our final understanding of the product required. If the items quoted do not reflect the intended product requirements of the customer, Palmieri will not be held responsible for increased costs for those product changes. We reserve the right to edit or re-quote any portion of a previously submitted quotation subject to our final understanding of the product required by the client.

**2. PALMIERI DRAWINGS**

Palmieri provides drawings for Custom & Standard product we produce to our clients upon request. We consider these drawings to be Private and Confidential and are provided for the sole purpose and use of our clients to understand the product we are providing. The use of these confidential materials is limited to the transaction between the parties and at no point are these confidential materials to be sent to any of our competitors or parties quoting for the same purpose.

**A minimum \$ 85.00 NET Engineering Administrative Fee will apply for Custom Product Drawings**

**(Note: The first set of Custom product drawings will be free of charge)**

**A minimum \$ 120.00 NET Engineering Administrative Fee will apply for all Standard Product Drawings**

### 3. TERMS OF PAYMENT

For authorized customers; Orders at a \$ 75,000.00 threshold will require a mandatory 25% deposit. Orders over and above \$ 100,000.00 requires a mandatory (25%) deposit at time of order, a mandatory (25%) deposit prior to product shipment and the balance to be paid within thirty (30) days of date of shipment. Payment not be made to Palmieri when due, Palmieri reserves the right to charge Purchaser with interest on such overdue payments. Interest of 2% per month (24% per annum) is charged on all overdue accounts, unless otherwise specified. The charging of such interest shall not be construed as obligating Palmieri to grant any extension of time in the terms of payment. All goods remain the property of Palmieri, until balance is paid in full to Palmieri.

### 4. TITLE

Title to the goods or any part thereof shall not pass from Palmieri to Purchaser until all payments due hereunder have been duly made, except as otherwise expressly stipulated herein. The goods shall be and remain personal or moveable property, notwithstanding their mode of attachment to realty or other property. If default is made in any of the payments herein, Purchaser agrees that Palmieri may retain all payments which have been made on account of the purchase price as liquidated damages, and Palmieri shall be free to enter the premises where the goods may be located and remove them as Palmieri's property, without prejudice to Palmieri's right to recover any further expenses or damages Palmieri may suffer by reason of such nonpayment.

### 5. TAXES

Prices do not include Goods & Services Tax, Provincial or Municipal sales, use, value-added or similar tax. All applicable taxes are extra. Our Harmonized Sales Tax (HST) registration number is R104055066.

### 6. THE AGREEMENT

An acceptance and official confirmation of Purchasers' order by signing Palmieri's Order Confirmation the Purchaser therefore is accepting terms and conditions as expressed herein Palmieri's Terms and Conditions of Quote and Sale by Palmieri and shall constitute the complete agreement, subject to the terms and conditions of sale herein set forth, and shall supersede all previous quotations, orders or agreements.

### 7. LEAD TIME / DELIVERY / DELAYS

Lead time is determined only when final material/finish selection and drawing approvals are received by Palmieri from the client. The accuracy of Palmieri's lead times, is created to the best of our ability with the information provided to us. Confirmed lead time is conveyed to the client by means of Order Confirmation. They do not preclude the client from checking the accuracy of your requirement and our Order Confirmation. Any noted discrepancies are to be reported immediately to Palmieri Customer Service Department for correction and re-issue of revised Order Confirmation. By signing and dating the Order Confirmation the client accepts the terms and conditions of quote and sale.

Lead time on our Order Confirmation do not account for delays that could potentially occur for special materials specified by the client that are outside of our standard finishes and materials program that are out of our control and will affect the lead time on the order. Palmieri will notify the client immediately when these delays occur and adjust the lead time accordingly.

Delivery schedules are approximate and are based on prevailing market conditions applicable respectively at

the time of Palmieri's quotation and Palmieri's acceptance of clients' order, if certain portions of an order are completed by the quoted lead time while other portions have experienced delays outside of our control. The client may choose to part ship the order at their discretion and expense. Otherwise the entire order will ship with the delayed portion at a later date. Palmieri may extend delivery schedules or may, at its option, cancel Purchaser's order in full or in part without liability other than to return any deposit or prepayment which is unearned by reason of the cancellation.

### 8. CHANGES AND CANCELLATION

Orders accepted by Palmieri are not subject to changes or cancellation by Purchaser without the written consent of Palmieri. In such cases where Palmieri authorizes changes or cancellation, Palmieri reserves the right to charge the Purchaser with reasonable costs based upon expenses already incurred and commitments made by Palmieri, including, without limitation, any labour done, material purchased and also including Supplier's usual overhead and reasonable profit and cancellation charges from Palmieri's suppliers. Palmieri will communicate to the Purchaser additional costs incurred by way of Revised Order Confirmation. Revised Order Confirmation will include applicable costs incurred and modification to lead times (if applicable). The Purchaser must provide Palmieri written confirmation of additional costs, before any changes can be processed on the order.

**A minimum charge of \$ 100.00 NET Change Order Request fee will apply**

**A minimum charge of \$ 150.00 NET Cancel Order Request fee will apply**

### 9. SHIPPING LOCATION / SHIPPING QUOTES / COST OF TRANSPORTATION

Unless otherwise stated, all prices are F.O.B. our factory in Richmond Hill, Ontario, Canada.

Customary methods of transportation shall be selected by Palmieri and such transportation will be at Purchaser's expense. Shipping quotations are made at time of furniture quotation and are outside the control of Palmieri. **Shipping quotes are valid for ten (10) business days from the time of quote.** We do our best to maintain shipping costs as quoted, however all shipping weights and cubic feet shown are approximate only, various construction materials and packaging methods may add to the weights given. All quoted prices, unless otherwise stated on the quotation, are based on the current exchange rates, tariffs, fuel surcharges and costs of manufacture and are subject to change by Palmieri with or without notice until Purchaser's acceptance. Palmieri does not assume responsibility or liability for shipping costs, product during transit, or variances from the shipping weights or cubic feet shown in our specification guides. Special methods of transportation will be used upon Purchaser's request and at Purchaser's additional expense, provided reasonable notice of Purchaser's transportation requirements are given by Purchaser to Palmieri prior to shipment. Palmieri will notify the client prior to shipping product if shipping costs as quoted change, at which point the client must approve the adjusted shipping costs.

### 10. RECEIVING PRODUCT / REPORTING DAMAGE / STORAGE OF PRODUCT

Upon receipt of Palmieri product, the receiver of the goods must immediately inspect the product to ensure it is free of shipping damage. If the product is deemed in good order, the receiver of the product must ensure

to sign off on the accompanying carriers Bill of lading in good condition. Except for obligations stated under "Warranty" herein, Palmieri's responsibility for the product ceases once the product has been received and signed off in good order and is the full responsibility of the receiver and subsequently the owner.

In the event shipping damage is discovered during receipt of shipment, it is the responsibility of the receiver to ensure all noted damage is recorded on the carrier's Bill of Lading prior to sign off. All noted shipping damage claims must be reported to Palmieri within **24 hours** of receipt of the product onsite, failure to do so will result in the claim being deemed null and void. All shipping damage claims are to be reported directly to Palmieri's Shipping Manager. Please call our toll free number at **1-800-413-4440 ext. 33** or submit the claim by Fax directly to **1-905-731-9878**. Palmieri will not accept any shipping damage claims submitted **after 24 hours** and it shall be conclusively presumed that the goods were delivered in good condition.

Storage of product, Palmieri will not be held responsible for any potential damages or shortages for product shipped and received by Purchaser and is subsequently placed into storage and not inspected within 24 hours of receipt.

#### 11. INSTALLATION / SHORTAGES / BACK CHARGES

Unless otherwise expressly stipulated, the goods shall be installed by and at the risk and expense of Purchaser.

In the event that Palmieri is requested to supervise such installation, Palmieri's responsibility shall be limited to exercising that degree of skill customary in the trade in supervising installations of the same type. Purchaser shall remain responsible for all other aspects of the work including compliance with the local regulations. It is the responsibility of the Purchaser to ensure hardware and parts are received in good order. Packing slip and hardware list to be provided by Palmieri with every order at time of shipping. Purchaser has the responsibility to notify Palmieri immediately without delay of issues that arise; subsequently Palmieri will take action to provide prompt resolution.

Shortages must be reported to Palmieri within **24 hours** of receipt of the goods and failure to do so may be at the expense of the Purchaser.

If deemed missing hardware and parts short shipped from the factory, Palmieri will arrange to ship freight prepaid to destination. Palmieri will only be responsible for replacement costs of missing hardware and parts, any labour costs incurred will be the responsibility of the Purchaser and will not be approved by Palmieri.

Back Charges will only be approved if we deemed a defect in the material or workmanship is found during the installation period resulting in a return trip to the job-site to complete installation. It shall remain the sole discretion of Palmieri to approve (A) repair or (B) replace the furniture and any labour costs incurred by the Purchaser.

#### 12. FORCE MAJEURE

Palmieri shall not be responsible or liable for any loss or damage incurred by Purchaser herein resulting from causes beyond the reasonable control of Palmieri including, but without limitation, abuse, misuse or accident, alteration or modification of product by customer or third party, normal wear and tear, improper installation, handling or incorrect use, unauthorized repairs, the substitution of part components or hardware not approved or authorized by Palmieri, improper storage, and environmental conditions such as irregular temperature control

either inside or outside the environment, acts of God, fire, flood, delays in transportation, or the failure of Palmieri's suppliers to meet their delivery promises. The acceptance of delivery of the goods by Purchaser shall constitute a waiver of all claims for loss or damage due to any delay whatsoever.

#### 13. RETURNED GOODS

No goods may be returned to Palmieri for a credit or exchanged without Palmieri's prior written consent.

Palmieri reserves the right to accept all returns and subject to a handling/restocking charge or to decline all returns. Even after Palmieri has authorized the return of goods for credit, Palmieri reserves the right to adjust the amount of any credit given to Purchaser on return of the goods based on the conditions of the goods on arrival in Palmieri's warehouse. Credit for returned goods will be issued to Purchaser only where such goods are returned by Purchaser and not by any subsequent owner of the goods. Goods will be considered for return only if they are in their original condition and packaging. Palmieri Goods Return Authorization Form to be issued and **must** accompany all shipments returning back to the factory. **Return freight must be prepaid by Purchaser. A minimum 20% re-stocking fee will apply.**

# PALMIERI

create. communicate. collaborate.

---

Palmieri Furniture Ltd.

1230 Reid Street  
Richmond Hill  
Ontario Canada L4B 1C4

T: 905 731 9300  
F: 905 731 9878  
TF: 800 413 4440

E: [info@palmierifurniture.com](mailto:info@palmierifurniture.com)  
W: [www.palmierifurniture.com](http://www.palmierifurniture.com)