

# PALLMER

P2<sup>®</sup>

SPECIFICATION GUIDE  
& PRICE LIST 2024

### WOODS & FINISHES:

#### Natural Maple Standard



Natural Clear – M-NA

#### Maple Finishes

The following stains are available, add 10% to list



Castle Oak – M-CO



Honey Oak – M-HO



English Oak – M-EN

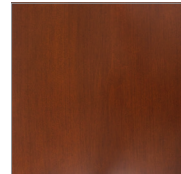

Victorian Cherry – M-VI



Richmond Cherry – M-RC

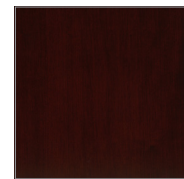

Mahogany – M-MA



Java – M-JA



Wenge – M-WE

#### Natural Red Oak Standard

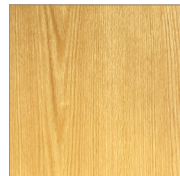

Natural Clear – O-NA

#### Red Oak Finishes

The following stains are available, add 10% to list

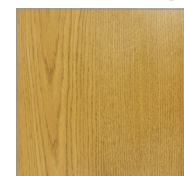

Castle Oak – O-CO

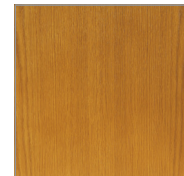

Honey Oak – O-HO

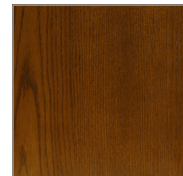

English Oak – O-EN

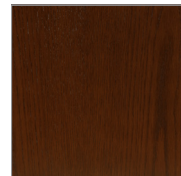

Victorian Cherry – O-VI



Richmond Cherry – O-RC



Mahogany – O-MA



Java – O-JA



Wenge – O-WE

#### Natural Cherry

Add 20% to list

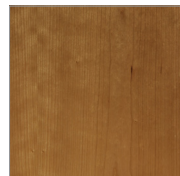

Natural Clear – C-NA

#### Cherry Finishes

The following stains are available, add 30% to list



Honey Oak – C-HO

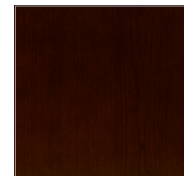

Richmond Cherry – C-RC

#### Natural Walnut

Add 20% to list



Natural Clear – W-NA

#### Walnut Finishes

The following stain is available, add 30% to list

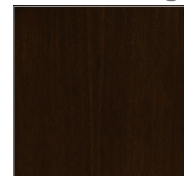

Java – W-JA

### WILSONART® LAMINATES:

Solid, Abstract and Wood Grain Options



Frosty White  
1573-60



Natural Almond  
D30-60

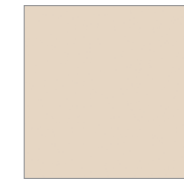

Beige  
1530-60



Fashion Grey  
D381-60



Dove Grey  
D92-60



Slate Grey  
D91-60



Black  
1595-60



Indigo  
D379-60



Maroochy Brush  
4745-60



Woolamai Brush  
4746-60

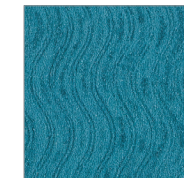

Blue Agave  
4919-60



Eggplant  
4913-60



Spiced Zephyr  
4859-60

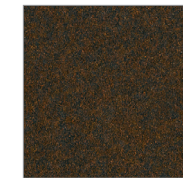

Morro Zephyr  
4846-60



Fusion Maple  
7909-60

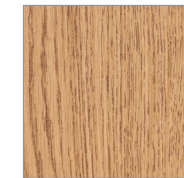

Bannister Oak  
7806-60



Mambo  
7948-60

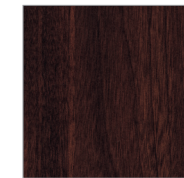

Cocobala  
7942-38



Walnut Heights  
7965-38



Wild Cherry  
7054-60



Phantom Pearl  
8211-38



White Driftwood  
8200-38



Grey Elm  
8201-38



Phantom Cocoa  
8213-38



Studio Teak  
7960-38



Skyline Walnut  
7964-38



Phantom Charcoal  
8214-38



Asian Night  
7949-38

### ABET LAMINATES:

Solid Colour Options

						
Bianco Ghiaccio 410	Beige 416	West Brown 892	Fondente 1828	Grigio Chiaro 478	Grigio Plomo 480	Grigio Scuro 871
						
Grigio Grafite 879	Nero 421	Giallo Pom Pom 463	Giallo Africa 469	Verde Erbetta 460	Sempreverde 451	Verde Biliardo 440
						
Verde Lauro 450	Verde Versailles 845	Bleu Panarea 482	Blu Amorgos 1824	Bleu California 499	Bleu Primario 838	Blu Cobalto 851
						
Blu Pavone 849	Blu Tenebre 1804	Blu Zaffiro 484	Blu Intenso 1818	Viola Madras 423	Viola Tramonto 424	Rosso Prugna 836
						
Rosso Antico 435	Rosso 431	Rosso Cavallino 1822	Arancio Canyon 835	Giallo Pop 861	Viola Sacro 1821	Fucsia 1840
						
Orchidea 1881	Viola Campanula 1827					

### METAL PAINT:

Thermal Paint Colours

						
White PS-111-W374	Antique White W11	Telegrey 4 RAL 7047	Grey A16	Zinc A67	Charcoal A230	Black N49
						
Black Sandtex N31	Sparkle Silver S11	Champagne S14	Beige Gray RAL 7006	Zinc Yellow RAL 1018	Traffic Yellow RAL 1023	Deep Orange RAL 2011
						
Traffic Red RAL 3020	Carmine Red RAL 3002	Purple Red RAL 3004	Claret Violet RAL 4004	Signa Violet RAL 4008	Traffic Purple RAL 4006	Blue Lilac RAL 4005
						
Yellow Green RAL 6018	Signal Green RAL 6032	Turquoise Green RAL 6016	Light Blue RAL 5012	Sky Blue RAL 5015	Gentian Blue RAL 5010	Cobalt Blue RAL 5013

### EDGE BAND COLOURS:

PVC edge band colour options

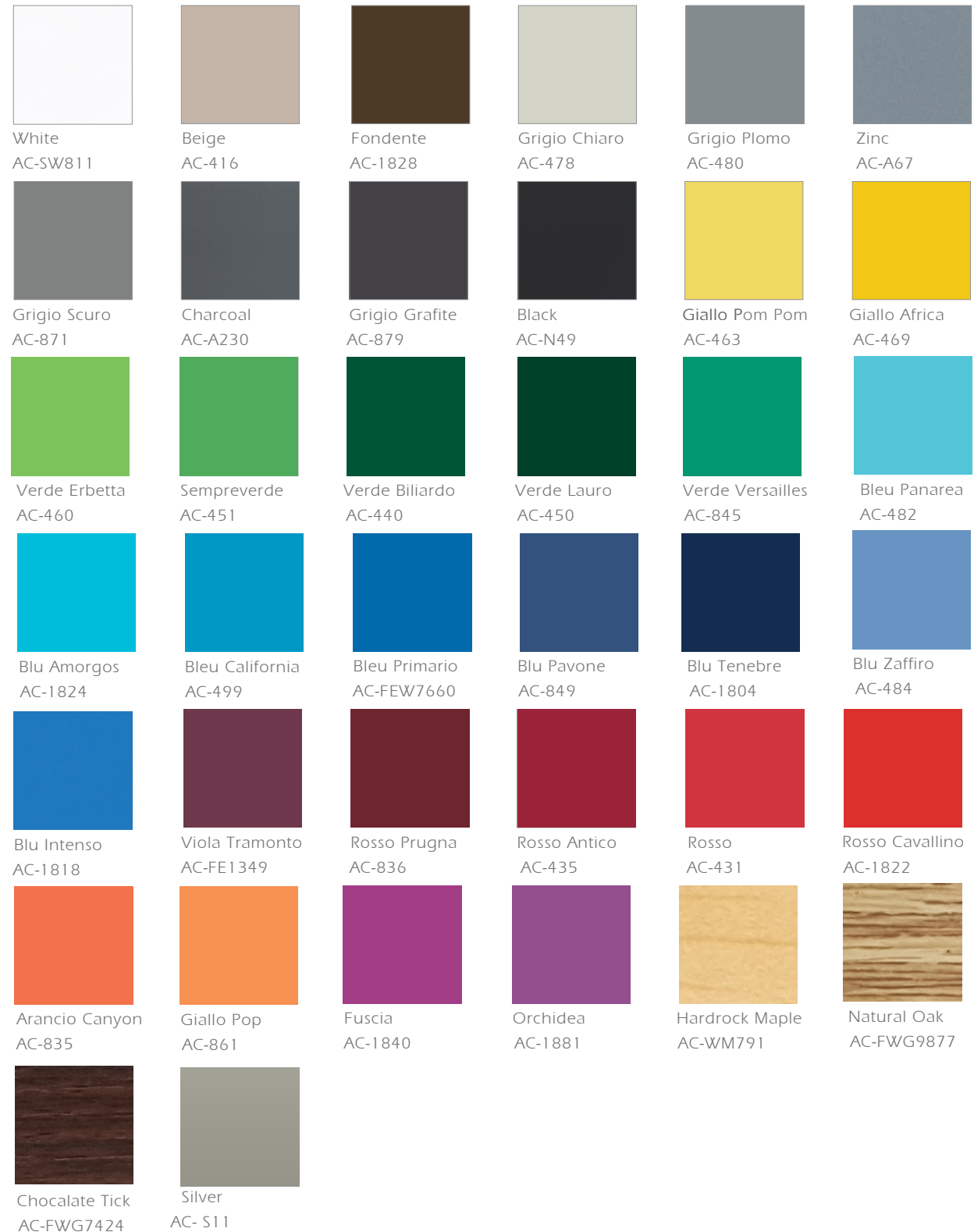

**HARDWOODS:** All hardwood materials used in the manufacturing of Palmieri products shall be Northern grown hardwoods. Hardwoods will be air and kiln dried to a moisture content of 5-7%. All hardwoods shall be of grade "A" material, free of material stains, imperfections, conformity of grain, texture and color. Hardwood species shall be Northern grown Red Oak, Clear White Northern Maple and Birch. American Cherry and Honduras Mahogany and Walnut are available. Please inquire for pricing.

**VENEER:** Exposed face veneers shall be not less than 1/28" thick plain sliced veneers. Veneers are to be selected for conformity of grain direction and color. Veneers are to be stitched tightly in a book match, slip match or plain sliced configuration. Unexposed veneers are to be of hardwood but not selected for color, or grain quality. Veneers are not to be lap joined or reveal any tape or glue lines.

**PARTICLE BOARD CORE:** The particleboard shall be formed of wood chips, bonded with a water resistance adhesive. The particleboard material is to be of a high density 45 lbs/cu. ft. having a minimum average modulus of rupture of 2400 psi and a minimum average modulus of elasticity of 4,000,000 psi.

**VENEER CORE:** Veneer core is to be constructed with odd numbers of plies. Each ply is to be laminated in pairs and cross banded in opposite directions with grain direction at a 90 degree angle to the grain of the center core. All plies are to be free from knots, wrinkles, laps or other natural or manufacturing defects.

**LUMBER CORE:** Lumber core is to be of the highest quality grade. Grade "A" select stock. Lumber core shall be constructed of solid random width strips not less than 2" wide nor more than 3 1/2" wide by 1" thick. Wood strips will be free from knots or other defects. All strips will be tightly joined using water resistance adhesives.





**HIGH PRESSURE LAMINATE:** Work surface laminate shall be .050" thick and used with balancing backer sheet of no less than .028" thick. Laminate shall conform to standards set by the American Standards Institute/National Electrical Manufacturers Association (ANSI/NEMA) for thickness, performance and appearance. Printed colours, abstract patterns and wood grains are reproduced from representative segments of large sheets and may differ slightly from the actual product.





**FINISHING PROCEDURES:** All materials shall be inspected and treated with a final sanding and polishing operation before any staining and final finishing can be performed. All machine and mill marks are to be removed. Once the polishing and sanding has been performed, the furniture will then undergo the following stain and finishing procedures:





- Step 1 A base stain will be uniformly applied, wiped and then allowed to dry under factory controlled conditions.
- Step 2 A uniform coat of sealer will be applied and allowed to dry.
- Step 3 Sealer will be lightly sanded using 240 grit silicon paper.
- Step 4 A catalytic lacquer of 34-45 degree sheen is evenly applied and allowed to dry under factory controlled conditions.



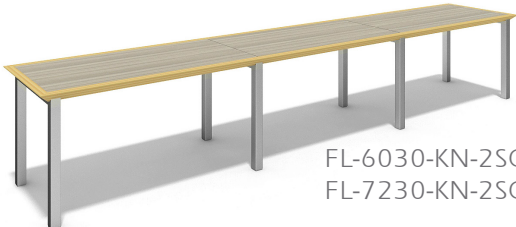

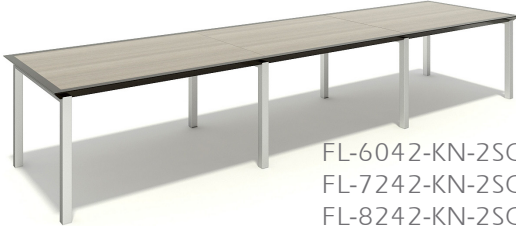

**METAL FINISHING PROCEDURES:** All metal components are thoroughly cleaned and coated electrostatically with an epoxy powder coat paint finish. The metal components are then oven baked and cured for a lasting finish.

**EDGE BANDS:** All edge bands are manufactured in PVC, semi-rigid (Flex) and ABS. Standard edging size are normally 1.25" wide x 2 mm thick. These are made of the highest grade polymers and its materials are extensively tested prior to production using special test procedures and industry specification and quality standards.





	MODEL NUMBER	PRODUCT	WIDTH	DEPTH	HEIGHT	WEIGHT	VOLUME	LIST PRICE	DESCRIPTION
		ROUND Tables, Knife Edge:							<p>Constructed of 1-1/8" thick 3-ply particleboard core, with 0.050" thick high pressure plastic laminate sheet on top surface. Bottom surface laminated with a 0.20" thick backing sheet.</p>  <p>Knife Edge is 2-1/4" wide x 1-3/4" high solid wood, with a 45 miter chamfer with 1/8" radius corners.</p> <p>Consists of two sets of steel legs and a top horizontal stretcher, constructed of 2" x 2" tubular 16 gauge steel. All metal is epoxy powder coated.</p> <p>Leveler: Legs are fitted with a threaded base to accept a 1-5/8" diameter cushioned glide, complete with a 1-1/2 x 3/8" threaded stem.</p>  <p>17-3/4" inside clearance for 36" diameter Round Tables 22" inside clearance for 42" diameter Round Tables 26-1/4" inside clearance for 48" diameter Round Tables</p> <p>Clean with a non-abrasive cleanser. Do not use powdered cleaning solutions as they may scratch the surface.</p> <p>Electrical and accessory options are available for purchase, see page 168-173 for details.</p>
	FL-R36-KN-2SQ		36"	36"	29"			\$ 2,744	
	FL-R42-KN-2SQ		42"	42"	29"			\$ 3,047	
	FL-R48-KN-2SQ		48"	48"	29"			\$ 3,234	
	FL-R54-KN-2SQ		54"	54"	29"			\$ 3,848	
FL-R60-KN-2SQ		60"	60"	29"			\$ 4,315		
		SQUARE Tables, Knife Edge:							
	FL-3636-KN-2SQ		36"	36"	29"			\$ 2,744	
	FL-4242-KN-2SQ		42"	42"	29"			\$ 2,915	
	FL-4848-KN-2SQ		48"	48"	29"			\$ 3,102	
FL-5454-KN-2SQ		54"	54"	29"			\$ 3,856		
		RECTANGLE Tables, Knife Edge:							
	FL-3036-KN-2SQ		36"	30"	29"			\$ 2,628	
	FL-3042-KN-2SQ		42"	30"	29"			\$ 2,736	
	FL-3048-KN-2SQ		48"	30"	29"			\$ 2,822	
	FL-3054-KN-2SQ		54"	30"	29"			\$ 2,899	
	FL-3060-KN-2SQ		60"	30"	29"			\$ 2,977	
	FL-3072-KN-2SQ		72"	30"	29"			\$ 3,134	
	FL-3642-KN-2SQ		42"	36"	29"			\$ 2,829	
	FL-3648-KN-2SQ		48"	36"	29"			\$ 2,930	
	FL-3654-KN-2SQ		54"	36"	29"			\$ 2,992	
	FL-3660-KN-2SQ		60"	36"	29"			\$ 3,077	
	FL-3672-KN-2SQ		72"	36"	29"			\$ 3,241	



	MODEL NUMBER	PRODUCT	WIDTH	DEPTH	HEIGHT	WEIGHT	VOLUME	LIST PRICE	DESCRIPTION
		RECTANGLE Tables, Knife Edge; Single Face							<p>Constructed of 1-1/8" thick 3-ply particleboard core, with 0.050" thick high pressure plastic laminate sheet on top surface. Bottom surface laminated with a 0.20" thick backing sheet.</p>  <p>Knife Edge is 2-1/4" wide x 1-3/4" high solid wood, with a 45 miter chamfer with 1/8" radius corners.</p> <p>Consists of two sets of steel legs and a top horizontal stretcher, constructed of 2" x 2" tubular 16 gauge steel. All metal is epoxy powder coated.</p> <p>Leveler: Legs are fitted with a threaded base to accept a 1-5/8" diameter cushioned glide, complete with a 1-1/2 x 3/8" threaded stem.</p>  <p>Clean with a non-abrasive cleanser. Do not use powdered cleaning solutions as they may scratch the surface.</p> <p>Electrical and accessory options are available for purchase, see page 168-173 for details.</p>
	FL-6030-KN-2SQ-ST	Starter	60"	30"	29"			\$ 3,077	
	FL-6030-KN-2SQ-AD	Adder	60"	30"	29"			\$ 2,708	
	FL-7230-KN-2SQ-ST	Starter	72"	30"	29"			\$ 3,146	
	FL-7230-KN-2SQ-AD	Adder	72"	30"	29"			\$ 2,769	
									
		RECTANGLE Tables, Knife Edge; Single Face							<p>Leveler: Legs are fitted with a threaded base to accept a 1-5/8" diameter cushioned glide, complete with a 1-1/2 x 3/8" threaded stem.</p>
	FL-6030-KN-2SQ-2P	2-Place	120"	30"	29"			\$ 5,788	
	FL-7230-KN-2SQ-2P	2-Place	144"	30"	29"			\$ 5,916	
		RECTANGLE Tables, Knife Edge; Single Face							<p>Leveler: Legs are fitted with a threaded base to accept a 1-5/8" diameter cushioned glide, complete with a 1-1/2 x 3/8" threaded stem.</p>
	FL-6030-KN-2SQ-3P	3-Place	180"	30"	29"			\$ 8,496	
	FL-7230-KN-2SQ-3P	3-Place	216"	30"	29"			\$ 8,684	

MODEL NUMBER	PRODUCT	WIDTH	DEPTH	HEIGHT	WEIGHT	VOLUME	LIST PRICE	DESCRIPTION
	RECTANGLE Tables, Knife Edge; Double Face							Constructed of 1-1/8" thick 3-ply particleboard core, with 0.050" thick high pressure plastic laminate sheet on top surface. Bottom surface laminated with a 0.20" thick backing sheet.
FL-6042-KN-2SQ-ST	Starter	60"	42"	29"			\$ 3,234	 Knife Edge is 2-1/4" wide x 1-3/4" high solid wood, with a 45 miter chamfer with 1/8" radius corners.  Consists of two sets of steel legs and a top horizontal stretcher, constructed of 2" x 2" tubular 16 gauge steel. All metal is epoxy powder coated.  Leveler: Legs are fitted with a threaded base to accept a 1-5/8" diameter cushioned glide, complete with a 1-1/2 x 3/8" threaded stem.    Clean with a non-abrasive cleanser. Do not use powdered cleaning solutions as they may scratch the surface.  Electrical and accessory options are available for purchase, see page 168-173 for details.  Three different LED light fixtures are available in a race (round) rail shape and sold separately. See page 172 for more details. 3 Rail Length Sizes to choose from: 1) 23¾" 2) 35¾" 3) 47¾"   This is an extruded aluminum fixture that have a slim and minimal profile. Ideal for tables, workstations, and carrel desks in corporate, library and educational settings.  This lighting option is only applicable to 42" & 48" table depths. Also, this is mounted per table and not continuously when ordering starters & adders.
FL-6042-KN-2SQ-AD	Adder	60"	42"	29"			\$ 2,846	
FL-7242-KN-2SQ-ST	Starter	72"	42"	29"			\$ 3,421	
FL-7242-KN-2SQ-AD	Adder	72"	42"	29"			\$ 3,011	
FL-8242-KN-2SQ-ST	Starter	82"	42"	29"			\$ 3,694	
FL-8242-KN-2SQ-AD	Adder	82"	42"	29"			\$ 3,259	
FL-9642-KN-2SQ-ST	Starter	96"	42"	29"			\$ 3,980	
FL-9642-KN-2SQ-AD	Adder	96"	42"	29"			\$ 3,590	
	RECTANGLE Tables, Knife Edge; Double Face							
FL-6042-KN-2SQ-2P	2-Place	120"	42"	29"			\$ 6,080	
FL-7242-KN-2SQ-2P	2-Place	144"	42"	29"			\$ 6,430	
FL-8242-KN-2SQ-2P	2-Place	164"	42"	29"			\$ 6,953	
FL-9642-KN-2SQ-2P	2-Place	192"	42"	29"			\$ 7,569	
	RECTANGLE Tables, Knife Edge; Double Face							
FL-6042-KN-2SQ-3P	3-Place	180"	42"	29"			\$ 8,925	
FL-7242-KN-2SQ-3P	3-Place	216"	42"	29"			\$ 9,440	
FL-8242-KN-2SQ-3P	3-Place	246"	42"	29"			\$ 10,211	
FL-9642-KN-2SQ-3P	3-Place	288"	42"	29"			\$ 11,158	

MODEL NUMBER	PRODUCT	WIDTH	DEPTH	HEIGHT	WEIGHT	VOLUME	LIST PRICE	DESCRIPTION
	RECTANGLE Tables, Knife Edge; Double Face							Constructed of 1-1/8" thick 3-ply particleboard core, with 0.050" thick high pressure plastic laminate sheet on top surface. Bottom surface laminated with a 0.20" thick backing sheet.
	FL-6048-KN-2SQ-ST Starter	60"	48"	29"			\$ 3,396	 <p>Knife Edge is 2-1/4" wide x 1-3/4" high solid wood, with a 45 miter chamfer with 1/8" radius corners.</p> <p>Consists of two sets of steel legs and a top horizontal stretcher, constructed of 2" x 2" tubular 16 gauge steel. All metal is epoxy powder coated.</p> <p>Leveler: Legs are fitted with a threaded base to accept a 1-5/8" diameter cushioned glide, complete with a 1-1/2 x 3/8" threaded stem.</p>  <p>Clean with a non-abrasive cleanser. Do not use powdered cleaning solutions as they may scratch the surface.</p> <p>Electrical and accessory options are available for purchase, see page 168-173 for details.</p> <p>Three different LED light fixtures are available in a race (round) rail shape and sold separately. See page 172 for more details. 3 Rail Length Sizes to choose from:</p> <ol style="list-style-type: none"> <li>1) 23¾"</li> <li>2) 35¾"</li> <li>3) 47¾"</li> </ol>  <p>This is an extruded aluminum fixture that have a slim and minimal profile. Ideal for tables, workstations, and carrel desks in corporate, library and educational settings.</p> <p>This lighting option is only applicable to 42" &amp; 48" table depths. Also, this is mounted per table and not continuously when ordering starters &amp; adders.</p>
	FL-6048-KN-2SQ-AD Adder	60"	48"	29"			\$ 2,988	
	FL-7248-KN-2SQ-ST Starter	72"	48"	29"			\$ 3,591	
	FL-7248-KN-2SQ-AD Adder	72"	48"	29"			\$ 3,160	
	FL-8248-KN-2SQ-ST Starter	82"	48"	29"			\$ 3,879	
	FL-8248-KN-2SQ-AD Adder	82"	48"	29"			\$ 3,422	
	FL-9648-KN-2SQ-ST Starter	96"	48"	29"			\$ 4,179	
	FL-9648-KN-2SQ-AD Adder	96"	48"	29"			\$ 3,769	
		RECTANGLE Tables, Knife Edge; Double Face						
		FL-6048-KN-2SQ-2P 2-Place	120"	48"	29"			\$ 6,382
		FL-7248-KN-2SQ-2P 2-Place	144"	48"	29"			\$ 6,752
FL-8248-KN-2SQ-2P 2-Place		164"	48"	29"			\$ 7,299	
FL-9648-KN-2SQ-2P 2-Place	192"	48"	29"			\$ 7,948		
	RECTANGLE Tables, Knife Edge; Double Face							
	FL-6048-KN-2SQ-3P 3-Place	180"	48"	29"			\$ 9,370	
	FL-7248-KN-2SQ-3P 3-Place	216"	48"	29"			\$ 9,911	
	FL-8248-KN-2SQ-3P 3-Place	246"	48"	29"			\$ 10,721	
FL-9648-KN-2SQ-3P 3-Place	288"	48"	29"			\$ 11,716		



	MODEL NUMBER	PRODUCT	WIDTH	DEPTH	HEIGHT	WEIGHT	VOLUME	LIST PRICE	DESCRIPTION
	FL-CS-3630-KN-2SQ	COMPUTER STATIONS, Knife Edge with Dividers 1-Place Starter	36"	30"	29"			\$ 3,739	<p>Constructed of 1-1/8" thick 3-ply particleboard core, with 0.050" thick high pressure plastic laminate sheet on top surface. Bottom surface laminated with a 0.20" thick backing sheet.</p>  <p>Knife Edge is 2-1/4" wide x 1-3/4" high solid wood, with a 45 miter chamfer with 1/8" radius corners.</p> <p>Consists of two sets of steel legs and a top horizontal stretcher, constructed of 2" x 2" tubular 16 gauge steel. All metal is epoxy powder coated.</p> <p>Leveler: Legs are fitted with a threaded base to accept a 1-5/8" diameter cushioned glide, complete with a 1-1/2 x 3/8" threaded stem.</p>
	FL-CS-3630-KN-2SQ-AD	Adder	36"	30"	29"			\$ 3,438	
	FL-CS-3630-KN-2SQ-2P	COMPUTER STATIONS, Knife Edge with Dividers 2-Place	72"	30"	29"			\$ 7,177	 <p>Clean with a non-abrasive cleanser. Do not use powdered cleaning solutions as they may scratch the surface.</p> <p>NOTE: For all Fluid Workstations the list price includes the Acrylic Surround Screen(s), Grommet(s), and J-Channel Wire Management.</p> <p>Electrical and accessory options are available for purchase, see page 168-173 for details.</p>
	FL-CS-3630-KN-2SQ-3P	COMPUTER STATIONS, Knife Edge with Dividers 3-Place	108"	30"	29"			\$ 10,617	

MODEL NUMBER	PRODUCT	WIDTH	DEPTH	HEIGHT	WEIGHT	VOLUME	LIST PRICE	DESCRIPTION
 FL-CS-D-7230-KN-2SQ FL-CS-D-7230-KN-2SQ-AD	COMPUTER STATIONS, Knife Edge with Dividers 2-Place						\$ 4,812	Constructed of 1-1/8" thick 3-ply particleboard core, with 0.050" thick high pressure plastic laminate sheet on top surface. Bottom surface laminated with a 0.20" thick backing sheet.
	Starter	72"	30"	29"			\$ 4,428	
 FL-CS-D-7230-KN-2SQ-4P	COMPUTER STATIONS, Knife Edge with Dividers 4-Place						\$ 9,240	Knife Edge is 2-1/4" wide x 1-3/4" high solid wood, with a 45 miter chamfer with 1/8" radius corners.
	Starter	144"	30"	29"				
 FL-CS-D-7230-KN-2SQ-6P	COMPUTER STATIONS, Knife Edge with Dividers 6-Place						\$ 13,668	Consists of two sets of steel legs and a top horizontal stretcher, constructed of 2" x 2" tubular 16 gauge steel. All metal is epoxy powder coated.
	Starter	216"	30"	29"				







Leveler: Legs are fitted with a threaded base to accept a 1-5/8" diameter cushioned glide, complete with a 1-1/2 x 3/8" threaded stem.













Clean with a non-abrasive cleanser. Do not use powdered cleaning solutions as they may scratch the surface.

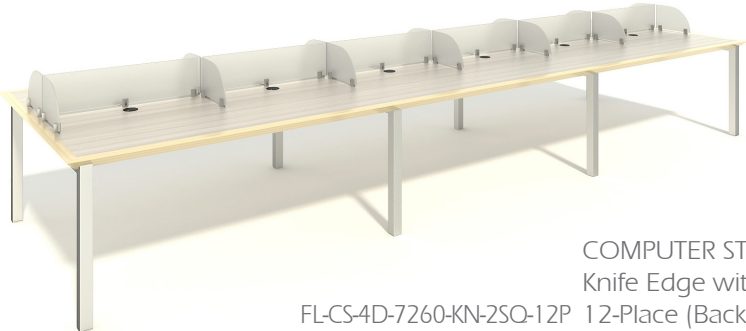





NOTE: For all Fluid Workstations the list price includes the Acrylic Surround Screen(s), Grommet(s), and J-Channel Wire Management.

Electrical and accessory options are available for purchase, see page 168-173 for details.

	MODEL NUMBER	PRODUCT	WIDTH	DEPTH	HEIGHT	WEIGHT	VOLUME	LIST PRICE	DESCRIPTION
	FL-CS-2D-3660-KN-2SQ	COMPUTER STATIONS, Knife Edge with Dividers 2-Place (Back to Back) Starter	36"	60"	29"			\$ 4,501	<p>Constructed of 1-1/8" thick 3-ply particleboard core, with 0.050" thick high pressure plastic laminate sheet on top surface. Bottom surface laminated with a 0.20" thick backing sheet.</p>  <p>Knife Edge is 2-1/4" wide x 1-3/4" high solid wood, with a 45 miter chamfer with 1/8" radius corners.</p> <p>Consists of two sets of steel legs and a top horizontal stretcher, constructed of 2" x 2" tubular 16 gauge steel. All metal is epoxy powder coated.</p> <p>Leveler: Legs are fitted with a threaded base to accept a 1-5/8" diameter cushioned glide, complete with a 1-1/2 x 3/8" threaded stem.</p>  <p>Clean with a non-abrasive cleanser. Do not use powdered cleaning solutions as they may scratch the surface.</p> <p>NOTE: For all Fluid Workstations the list price includes the Acrylic Surround Screen(s), Grommet(s), and J-Channel Wire Management.</p> <p>Electrical and accessory options are available for purchase, see page 168-173 for details.</p>
	FL-CS-2D-3660-KN-2SQ-AD	Adder	36"	60"	29"			\$ 4,142	
	FL-CS-2D-3660-KN-2SQ-4P	COMPUTER STATIONS, Knife Edge with Dividers 4-Place (Back to Back)	72"	60"	29"			\$ 4,911	
	FL-CS-2D-3660-KN-2SQ-6P	COMPUTER STATIONS, Knife Edge with Dividers 6-Place (Back to Back)	108"	60"	29"			\$ 9,053	

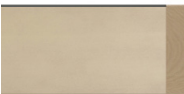
MODEL NUMBER	PRODUCT	WIDTH	DEPTH	HEIGHT	WEIGHT	VOLUME	LIST PRICE	DESCRIPTION
 FL-CS4D-7260-KN-2SQ FL-CS4D-7260-KN-2SQ-AD	COMPUTER STATIONS, Knife Edge with Dividers 4-Place (Back to Back)							Constructed of 1-1/8" thick 3-ply particleboard core, with 0.050" thick high pressure plastic laminate sheet on top surface. Bottom surface laminated with a 0.20" thick backing sheet.   Knife Edge is 2-1/4" wide x 1-3/4" high solid wood, with a 45 miter chamfer with 1/8" radius corners.  Consists of two sets of steel legs and a top horizontal stretcher, constructed of 2" x 2" tubular 16 gauge steel. All metal is epoxy powder coated.  Leveler: Legs are fitted with a threaded base to accept a 1-5/8" diameter cushioned glide, complete with a 1-1/2 x 3/8" threaded stem.    Clean with a non-abrasive cleanser. Do not use powdered cleaning solutions as they may scratch the surface.  NOTE: For all Fluid Workstations the list price includes the Acrylic Surround Screen(s), Grommet(s), and J-Channel Wire Management.  Electrical and accessory options are available for purchase, see page 168-173 for details.
	Starter	72"	60"	29"			\$ 5,963	
Adder	72"	60"	29"			\$ 5,484		
 FL-CS4D-7260-KN-2SQ-8P	COMPUTER STATIONS, Knife Edge with Dividers 8-Place (Back to Back)	144"	60"	29"			\$ 11,447	
 FL-CS4D-7260-KN-2SQ-12P	COMPUTER STATIONS, Knife Edge with Dividers 12-Place (Back to Back)	216"	60"	29"			\$ 16,931	

	MODEL NUMBER	PRODUCT	WIDTH	DEPTH	HEIGHT	WEIGHT	VOLUME	LIST PRICE	DESCRIPTION
		SQUARE Tables, Knife Edge with Lighting:							<p>Constructed of 1-1/8" thick 3-ply particleboard core, with 0.050" thick high pressure plastic laminate sheet on top surface. Bottom surface laminated with a 0.20" thick backing sheet.</p>  <p>Knife Edge is 2-1/4" wide x 1-3/4" high solid wood, with a 45 miter chamfer with 1/8" radius corners.</p> <p>Consists of two sets of steel legs and a top horizontal stretcher, constructed of 2" x 2" tubular 16 gauge steel. All metal is epoxy powder coated.</p>
	FL-4242-KN-2SQ-VL	23¾" LED	42"	42"	29"			Inquire for Quote	
	FL-4848-KN-2SQ-VL	23¾" LED	48"	48"	29"				
	FL-5454-KN-2SQ-VL	35¾" LED	54"	54"	29"				
		RECTANGLE Tables, Knife Edge with Lighting:							<p>Leveler: Legs are fitted with a threaded base to accept a 1-5/8" diameter cushioned glide, complete with a 1-1/2 x 3/8" threaded stem.</p>  <p>Clean with a non-abrasive cleanser. Do not use powdered cleaning solutions as they may scratch the surface.</p> <p>Electrical and accessory options are available for purchase, see page 168-173 for details.</p> <p>Three different LED light fixtures are available in a race (round) rail shape and sold separately. See page 172 for more details. 3 Rail Length Sizes to choose from:</p> <ol style="list-style-type: none"> <li>1) 23¾"</li> <li>2) 35¾"</li> <li>3) 47¾"</li> </ol>  <p>This is an extruded aluminum fixture that have a slim and minimal profile. Ideal for tables, workstations, and carrel desks in corporate, library and educational settings.</p>
	FL-4248-KN-2SQ-VL	23¾" LED	48"	42"	29"			Inquire for Quote	
	FL-4254-KN-2SQ-VL	35¾" LED	54"	42"	29"				
	FL-4260-KN-2SQ-VL	35¾" LED	60"	42"	29"				
	FL-4272-KN-2SQ-VL	47¾" LED	72"	42"	29"				
	FL-4854-KN-2SQ-VL	35¾" LED	54"	48"	29"			Inquire for Quote	
	FL-4860-KN-2SQ-VL	35¾" LED	60"	48"	29"				
	FL-4872-KN-2SQ-VL	47¾" LED	72"	48"	29"				

	MODEL NUMBER	PRODUCT	WIDTH	DEPTH	HEIGHT	WEIGHT	VOLUME	LIST PRICE	DESCRIPTION
	LG-T-AC-STC LG-T-SQ-STC	Table Pod Acrylic Edge Square Edge	47 1/2"	24"	29"	23 Lbs.	19.5 Cu Ft	\$ 1,244 \$ 1,290	<p>Small and Large Table Pods connect to the Center Pod to create workstations. The Pods connect on a swivel hinge allowing them to be easily adjusted to endless different user configurations.</p> <p>An optional Power Sphere connects into the top middle of the Center Pod which can supply four power outlets or two power and two data outlets.</p> <p>There are two edge profiles available:</p> <div style="display: flex; justify-content: space-around;"> <div style="text-align: center;">  <p>Model "AC" 2 mm Vinyl Acrylic Edge</p> </div> <div style="text-align: center;">  <p>Model "SQ" 1/8" Square Edge</p> </div> </div>
	LG-L-AC-STC LG-L-SQ-STC	Large Table Pod Acrylic Edge Square Edge	34 1/4"	34 1/4"	29"	31 Lbs.	20 Cu Ft	\$ 1,508 \$ 1,571	
	LG-CP4-AC LG-CP4-SQ	Center Pod: Quad Acrylic Edge Square Edge	28 1/2"	28 1/2"	27 1/2"	105 Lbs.	13 Cu Ft	\$ 2,107 \$ 2,153	
	LG-CP3-AC LG-CP3-SQ	Center Pod: Triple Acrylic Edge Square Edge	28 1/2"	28 1/2"	27 1/2"			\$ 2,053 \$ 2,091	 <p>Model "STC" Straight Caster Leg</p>



### CONFIGURATION A: TRIPLE WORKSTATION

- LG-CA-AC-STC Acrylic Edge, Straight Caster **\$ 5,785**
- LG-CA-SO-STC Square Edge, Straight Caster **\$ 5,963**

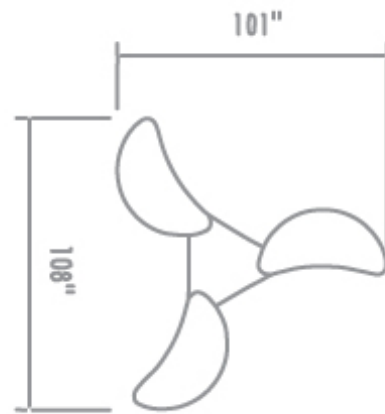

### CONFIGURATION B: QUAD WORKSTATION

- LG-CB-AC-STC Acrylic Edge, Straight Caster **\$ 7,082**
- LG-CB-SO-STC Square Edge, Straight Caster **\$ 7,314**

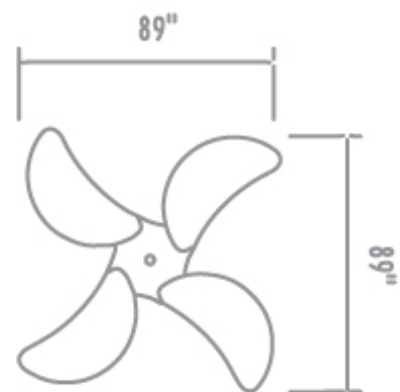

### CONFIGURATION C: TRIPLE WORKSTATION, 1 LARGE & 2 SMALL PODS



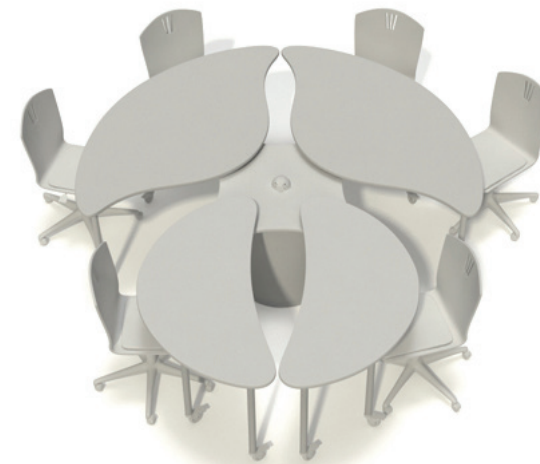
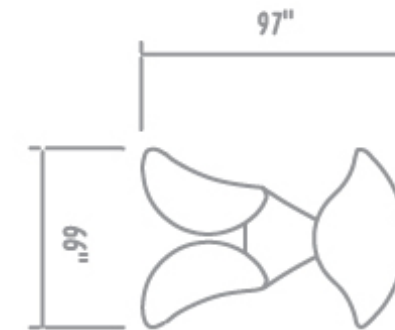

- LG-CC-AC-STC Acrylic Edge, Straight Caster **\$ 6,048**
- LG-CC-SO-STC Square Edge, Straight Caster **\$ 6,243**



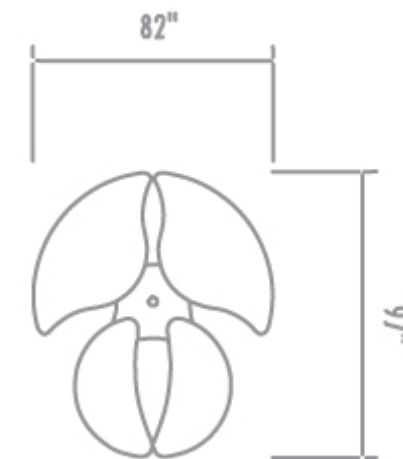

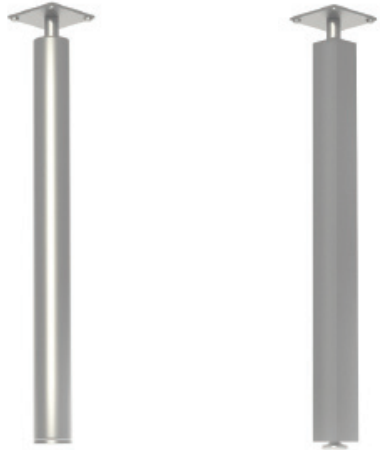

### CONFIGURATION D: QUAD WORKSTATION, 2 LARGE & 2 SMALL PODS





- LG-CD-AC-STC Acrylic Edge, Straight Caster **\$ 7,611**
- LG-CD-SO-STC Square Edge, Straight Caster **\$ 7,874**

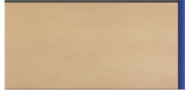





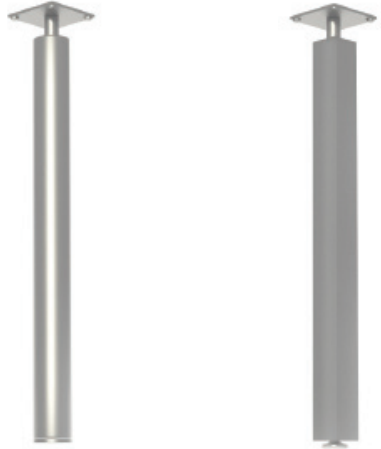





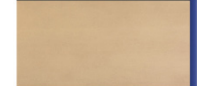

MODEL NUMBER	PRODUCT	WIDTH	DEPTH	HEIGHT	WEIGHT	VOLUME	LIST PRICE	DESCRIPTION
	48" Width Tables;	48"	48"	29"	60.5 Lbs.	2 Cu Ft		<p>Each unit is a single user unit which can be combined together to create two and four user stations.</p> <p>Two edge profiles available:</p>  <p>Model "PN"      Model "AC" 2" Pencil Edge      2 mm Acrylic Edge</p> <p>There is an option for a Grommet and Wire Management leg for this table. In addition to the above, there is also a 1/4" thick frosted acrylic divider screen available for this table.</p> <p>There are two different leg styles available:</p>  <p>Model "R"      Model "S" 2 1/2" Diameter &amp; Stem Leg      2" Square &amp; Stem Leg</p>
	PD-T4848-PN-R      Pencil Edge; Dia. & Stem Leg PD-T4848-PN-S      Pencil Edge; Square & Stem Leg PD-T4848-AC-R      Acrylic Edge; Dia. & Stem Leg PD-T4848-AC-S      Acrylic Edge; Square & Stem Leg						\$ 2,487 \$ 2,487 \$ 2,301 \$ 2,301	
	60" Width Tables;	60"	60"	29"	72 Lbs.	2.5 Cu Ft		
	PD-T6060-PN-R      Pencil Edge; Dia. & Stem Leg PD-T6060-PN-S      Pencil Edge; Square & Stem Leg PD-T6060-AC-R      Acrylic Edge; Dia. & Stem Leg PD-T6060-AC-S      Acrylic Edge; Square & Stem Leg						\$ 2,705 \$ 2,705 \$ 2,512 \$ 2,512	
	48" Width Tables; 1 Grommet; 1 Wire Management Leg;	48"	48"	29"	60.5 Lbs.	2 Cu Ft		
	PD-T4848-PN-R-GW      Pencil Edge; Dia. & Stem Leg PD-T4848-PN-S-GW      Pencil Edge; Square & Stem Leg PD-T4848-AC-R-GW      Acrylic Edge; Dia. & Stem Leg PD-T4848-AC-S-GW      Acrylic Edge; Square & Stem Leg						\$ 2,636 \$ 2,636 \$ 2,450 \$ 2,450	
	60" Width Tables; 1 Grommet; 1 Wire Management Leg;	60"	60"	29"	72 Lbs.	2.5 Cu Ft		
	PD-T6060-PN-R-GW      Pencil Edge; Dia. & Stem Leg PD-T6060-PN-S-GW      Pencil Edge; Square & Stem Leg PD-T6060-AC-R-GW      Acrylic Edge; Dia. & Stem Leg PD-T6060-AC-S-GW      Acrylic Edge; Square & Stem Leg						\$ 2,853 \$ 2,853 \$ 2,660 \$ 2,660	







MODEL NUMBER	PRODUCT	WIDTH	DEPTH	HEIGHT	WEIGHT	VOLUME	LIST PRICE	DESCRIPTION
	48" Width Tables; 1 Grommet; 1 Wire Management Leg; 2 Acrylic Dividers;	48"	48"	29"	64 Lbs.	2 Cu Ft		Each unit is a single user unit which can be combined together to create two and four user stations.  Two edge profiles available:
	PD-T4848-PN-R-GWA Pencil Edge; Dia. & Stem Leg						\$ 3,458	 
	PD-T4848-PN-S-GWA Pencil Edge; Square & Stem Leg						\$ 3,458	
	PD-T4848-AC-R-GWA Acrylic Edge; Dia. & Stem Leg						\$ 3,273	
PD-T4848-AC-S-GWA Acrylic Edge; Square & Stem Leg						\$ 3,273		
	60" Width Tables; 1 Grommet; 1 Wire Management Leg; 2 Acrylic Dividers;	60"	60"	29"	76 Lbs.	2.5 Cu Ft		Model "PN" 2" Pencil Edge Model "AC" 2 mm Acrylic Edge  There is an option for a Grommet and Wire Management leg for this table. In addition to the above, there is also a 1/4" thick frosted acrylic divider screen available for this table.
	PD-T6060-PN-R-GWA Pencil Edge; Dia. & Stem Leg						\$ 3,677	 
	PD-T6060-PN-S-GWA Pencil Edge; Square & Stem Leg						\$ 3,677	
	PD-T6060-AC-R-GWA Acrylic Edge; Dia. & Stem Leg						\$ 3,482	
PD-T6060-AC-S-GWA Acrylic Edge; Square & Stem Leg						\$ 3,482		
There are two different leg styles available:								
								Model "R" 2 1/2" Diameter & Stem Leg
								Model "S" 2" Square & Stem Leg



MODEL NUMBER	PRODUCT	WIDTH	DEPTH	HEIGHT	WEIGHT	VOLUME	LIST PRICE	DESCRIPTION
	2 PERSON Unit: 48" Depth;	96"	48"	29"				<p>Each unit is a two person unit which can be combined together to create four user stations.</p> <p>Two edge profiles available:</p>  <p>Model "PN"      Model "AC" 2" Pencil Edge      2 mm Acrylic Edge</p> <p>There is an option for a Grommet and Wire Management leg for this table. In addition to the above, there is also a 1/4" thick frosted acrylic divider screen available for this table.</p> <p>There are two different leg styles available:</p>  <p>Model "R"      Model "S" 2 1/2" Diameter &amp; Stem Leg      2" Square &amp; Stem Leg</p>
	PD-CB48-PN-R	Pencil Edge; Dia. & Stem Leg					\$ 4,260	
	PD-CB48-PN-S	Pencil Edge; Square & Stem Leg					\$ 4,260	
	PD-CB48-AC-R	Acrylic Edge; Dia. & Stem Leg					\$ 4,074	
PD-CB48-AC-S	Acrylic Edge; Square & Stem Leg					\$ 4,074		
	2 PERSON Unit: 60" Depth;	120"	60"	29"				
	PD-CB60-PN-R	Pencil Edge; Dia. & Stem Leg					\$ 4,687	
	PD-CB60-PN-S	Pencil Edge; Square & Stem Leg					\$ 4,687	
	PD-CB60-AC-R	Acrylic Edge; Dia. & Stem Leg					\$ 4,494	
PD-CB60-AC-S	Acrylic Edge; Square & Stem Leg					\$ 4,494		
	2 PERSON Unit: 48" Depth; 2 Grommets; 1 Wire Management Leg;	96"	48"	29"				
	PD-CB48-PN-R-GW	Pencil Edge; Dia. & Stem Leg					\$ 4,540	
	PD-CB48-PN-S-GW	Pencil Edge; Square & Stem Leg					\$ 4,540	
	PD-CB48-AC-R-GW	Acrylic Edge; Dia. & Stem Leg					\$ 4,354	
PD-CB48-AC-S-GW	Acrylic Edge; Square & Stem Leg					\$ 4,354		
	2 PERSON Unit: 60" Depth; 2 Grommets; 1 Wire Management Leg;	120"	60"	29"				
	PD-CB60-PN-R-GW	Pencil Edge; Dia. & Stem Leg					\$ 4,968	
	PD-CB60-PN-S-GW	Pencil Edge; Square & Stem Leg					\$ 4,968	
	PD-CB60-AC-R-GW	Acrylic Edge; Dia. & Stem Leg					\$ 4,775	
PD-CB60-AC-S-GW	Acrylic Edge; Square & Stem Leg					\$ 4,775		

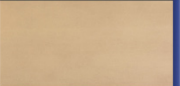



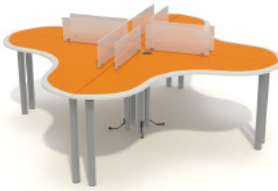

MODEL NUMBER	PRODUCT	WIDTH	DEPTH	HEIGHT	WEIGHT	VOLUME	LIST PRICE	DESCRIPTION
	2 PERSON Unit: 48" Depth; 2 Grommets; 1 Wire Management Leg; 3 Acrylic Dividers;	96"	48"	29"				Each unit is a two person unit which can be combined together to create four user stations.
	Pencil Edge; Dia. & Stem Leg						\$ 5,775	Two edge profiles available:
	Pencil Edge; Square & Stem Leg						\$ 5,775	
	Acrylic Edge; Dia. & Stem Leg						\$ 5,589	
	Acrylic Edge; Square & Stem Leg						\$ 5,589	
	2 PERSON Unit: 60" Depth; 2 Grommets; 1 Wire Management Leg; 3 Acrylic Dividers;	120"	60"	29"				Model "PN"      Model "AC" 2" Pencil Edge      2 mm Acrylic Edge
	Pencil Edge; Dia. & Stem Leg						\$ 6,204	There is an option for a Grommet and Wire Management leg for this table. In addition to the above, there is also a 1/4" thick frosted acrylic divider screen available for this table.
	Pencil Edge; Square & Stem Leg						\$ 6,204	
	Acrylic Edge; Dia. & Stem Leg						\$ 6,011	There are two different leg styles available:
	Acrylic Edge; Square & Stem Leg						\$ 6,011	 
								Model "R" 2 1/2" Diameter & Stem Leg
								Model "S" 2" Square & Stem Leg

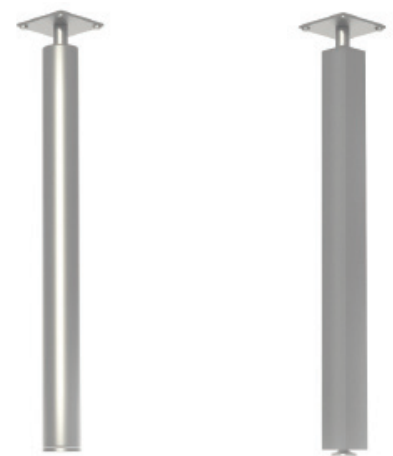
	MODEL NUMBER	PRODUCT	WIDTH	DEPTH	HEIGHT	WEIGHT	VOLUME	LIST PRICE	DESCRIPTION
		4 PERSON UNIT: Shared Leg; 48" Depth;	96"	96"	29"				Each unit is a four person unit.
	PD-CE48-PN-R	Pencil Edge; Dia. & Stem Leg						\$ 6,840	Two edge profiles available:    Model "PN" 2" Pencil Edge      Model "AC" 2 mm Acrylic Edge  There is an option for a Grommet and Wire Management leg for this table. In addition to the above, there is also a 1/4" thick frosted acrylic divider screen available for this table.
	PD-CE48-PN-S	Pencil Edge; Square & Stem Leg					\$ 6,840		
	PD-CE48-AC-R	Acrylic Edge; Dia. & Stem Leg					\$ 6,655		
PD-CE48-AC-S	Acrylic Edge; Square & Stem Leg					\$ 6,655			
		4 PERSON UNIT: Shared Leg; 60" Depth;	120"	120"	29"				
	PD-CE60-PN-R	Pencil Edge; Dia. & Stem Leg						\$ 7,697	There are two different leg styles available:     Model "R" 2 1/2" Diameter & Stem Leg      Model "S" 2" Square & Stem Leg
	PD-CE60-PN-S	Pencil Edge; Square & Stem Leg					\$ 7,697		
	PD-CE60-AC-R	Acrylic Edge; Dia. & Stem Leg					\$ 7,504		
PD-CE60-AC-S	Acrylic Edge; Square & Stem Leg					\$ 7,504			
		4 PERSON UNIT: Shared Leg; 48" Depth; 4 Grommets; 1 Wire Management Leg;	96"	96"	29"				
	PD-CE48-PN-R-GW	Pencil Edge; Dia. & Stem Leg						\$ 7,385	There are two different leg styles available:     Model "R" 2 1/2" Diameter & Stem Leg      Model "S" 2" Square & Stem Leg
	PD-CE48-PN-S-GW	Pencil Edge; Square & Stem Leg					\$ 7,385		
	PD-CE48-AC-R-GW	Acrylic Edge; Dia. & Stem Leg					\$ 7,199		
PD-CE48-AC-S-GW	Acrylic Edge; Square & Stem Leg					\$ 7,199			
		4 PERSON UNIT: Shared Leg; 60" Depth; 4 Grommets; 1 Wire Management Leg;	120"	120"	29"				
	PD-CE60-PN-R-GW	Pencil Edge; Dia. & Stem Leg						\$ 8,240	There are two different leg styles available:     Model "R" 2 1/2" Diameter & Stem Leg      Model "S" 2" Square & Stem Leg
	PD-CE60-PN-S-GW	Pencil Edge; Square & Stem Leg					\$ 8,240		
	PD-CE60-AC-R-GW	Acrylic Edge; Dia. & Stem Leg					\$ 8,047		
PD-CE60-AC-S-GW	Acrylic Edge; Square & Stem Leg					\$ 8,047			

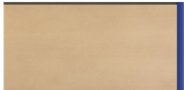

MODEL NUMBER	PRODUCT	WIDTH	DEPTH	HEIGHT	WEIGHT	VOLUME	LIST PRICE	DESCRIPTION
	4 PERSON UNIT: Shared Leg; 48" Depth; 4 Grommets; 1 Wire Management Leg; 4 Acrylic Dividers;	96"	96"	29"				Each unit is a four person unit.
	PD-CE48-PN-R-GWA Pencil Edge; Dia. & Stem Leg						\$ 9,033	Two edge profiles available:   Model "PN" 2" Pencil Edge      Model "AC" 2 mm Acrylic Edge
	PD-CE48-PN-S-GWA Pencil Edge; Square & Stem Leg						\$ 9,033	
	PD-CE48-AC-R-GWA Acrylic Edge; Dia. & Stem Leg						\$ 8,847	
PD-CE48-AC-S-GWA Acrylic Edge; Square & Stem Leg						\$ 8,847		
	4 PERSON UNIT: Shared Leg; 60" Depth; 4 Grommets; 1 Wire Management Leg; 4 Acrylic Dividers;	120"	120"	29"				There is an option for a Grommet and Wire Management leg for this table. In addition to the above, there is also a 1/4" thick frosted acrylic divider screen available for this table.
	PD-CE60-PN-R-GWA Pencil Edge; Dia. & Stem Leg						\$ 9,888	There are two different leg styles available:   Model "R" 2 1/2" Diameter & Stem Leg      Model "S" 2" Square & Stem Leg
	PD-CE60-PN-S-GWA Pencil Edge; Square & Stem Leg						\$ 9,888	
	PD-CE60-AC-R-GWA Acrylic Edge; Dia. & Stem Leg						\$ 9,695	
PD-CE60-AC-S-GWA Acrylic Edge; Square & Stem Leg						\$ 9,695		







MODEL NUMBER	PRODUCT	WIDTH	DEPTH	HEIGHT	WEIGHT	VOLUME	LIST PRICE	DESCRIPTION
	4 PERSON UNIT: Individual Tables; 48" Depth;	96"	96"	29"				<p>Each unit is a single user unit which can be combined together to create two and four user stations.</p> <p>Two edge profiles available:</p>  <p>Model "PN" 2" Pencil Edge      Model "AC" 2 mm Acrylic Edge</p> <p>There is an option for a Grommet and Wire Management leg for this table. In addition to the above, there is also a 1/4" thick frosted acrylic divider screen available for this table.</p> <p>There are two different leg styles available:</p>  <p>Model "R" 2 1/2" Diameter &amp; Stem Leg      Model "S" 2" Square &amp; Stem Leg</p>
	PD-CA48-PN-R	Pencil Edge; Dia. & Stem Leg					\$ 9,950	
	PD-CA48-PN-S	Pencil Edge; Square & Stem Leg					\$ 9,950	
	PD-CA48-AC-R	Acrylic Edge; Dia. & Stem Leg					\$ 9,206	
PD-CA48-AC-S	Acrylic Edge; Square & Stem Leg					\$ 9,206		
	4 PERSON UNIT: Individual Tables; 60" Depth;	120"	120"	29"				<p>Model "R" 2 1/2" Diameter &amp; Stem Leg      Model "S" 2" Square &amp; Stem Leg</p>
	PD-CA60-PN-R	Pencil Edge; Dia. & Stem Leg					\$ 10,820	
	PD-CA60-PN-S	Pencil Edge; Square & Stem Leg					\$ 10,820	
	PD-CA60-AC-R	Acrylic Edge; Dia. & Stem Leg					\$ 10,046	
PD-CA60-AC-S	Acrylic Edge; Square & Stem Leg					\$ 10,046		
	4 PERSON UNIT: Individual Tables; 48" Depth; 4 Grommets; 4 Wire Management Legs;	96"	96"	29"				<p>Model "R" 2 1/2" Diameter &amp; Stem Leg      Model "S" 2" Square &amp; Stem Leg</p>
	PD-CA48-PN-R-GW	Pencil Edge; Dia. & Stem Leg					\$ 10,540	
	PD-CA48-PN-S-GW	Pencil Edge; Square & Stem Leg					\$ 10,540	
	PD-CA48-AC-R-GW	Acrylic Edge; Dia. & Stem Leg					\$ 9,800	
PD-CA48-AC-S-GW	Acrylic Edge; Square & Stem Leg					\$ 9,800		
	4 PERSON UNIT: Individual Tables; 60" Depth; 4 Grommets; 4 Wire Management Legs;	120"	120"	29"				<p>Model "R" 2 1/2" Diameter &amp; Stem Leg      Model "S" 2" Square &amp; Stem Leg</p>
	PD-CA60-PN-R-GW	Pencil Edge; Dia. & Stem Leg					\$ 11,411	
	PD-CA60-PN-S-GW	Pencil Edge; Square & Stem Leg					\$ 11,411	
	PD-CA60-AC-R-GW	Acrylic Edge; Dia. & Stem Leg					\$ 10,641	
PD-CA60-AC-S-GW	Acrylic Edge; Square & Stem Leg					\$ 10,641		

MODEL NUMBER	PRODUCT	WIDTH	DEPTH	HEIGHT	WEIGHT	VOLUME	LIST PRICE	DESCRIPTION
	4 PERSON UNIT: Individual Tables; 96" 48" Depth; 4 Grommets; 4 Wire Management Legs; 8 Acrylic Dividers;	96"	48"	29"				Each unit is a single user unit which can be combined together to create two and four user stations.
	PD-CA48-PN-R-GWA Pencil Edge; Dia. & Stem Leg						\$ 13,837	<p>Two edge profiles available:</p>  <p>Model "PN" 2" Pencil Edge      Model "AC" 2 mm Acrylic Edge</p>
	PD-CA48-PN-S-GWA Pencil Edge; Square & Stem Leg					\$ 13,837		
	PD-CA48-AC-R-GWA Acrylic Edge; Dia. & Stem Leg					\$ 13,089		
	PD-CA48-AC-S-GWA Acrylic Edge; Square & Stem Leg					\$ 13,089		
	4 PERSON UNIT: Individual Tables; 120" 60" Depth; 4 Grommets; 4 Wire Management Leg;s 8 Acrylic Dividers;	120"	60"	29"				There is an option for a Grommet and Wire Management leg for this table. In addition to the above, there is also a 1/4" thick frosted acrylic divider screen available for this table.
	PD-CA60-PN-R-GWA Pencil Edge; Dia. & Stem Leg						\$ 14,707	<p>There are two different leg styles available:</p>  <p>Model "R" 2 1/2" Diameter &amp; Stem Leg      Model "S" 2" Square &amp; Stem Leg</p>
	PD-CA60-PN-S-GWA Pencil Edge; Square & Stem Leg					\$ 14,707		
	PD-CA60-AC-R-GWA Acrylic Edge; Dia. & Stem Leg					\$ 13,930		
	PD-CA60-AC-S-GWA Acrylic Edge; Square & Stem Leg					\$ 13,930		

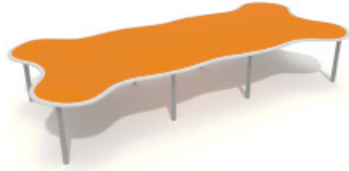

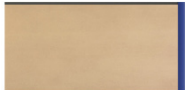



MODEL NUMBER	PRODUCT	WIDTH	DEPTH	HEIGHT	WEIGHT	VOLUME	LIST PRICE	DESCRIPTION	
	6 PERSON UNIT: 48" Depth;	96"	48"	29"				Each unit is a six person unit.	
	PD-CG48-PN-R	Pencil Edge; Dia. & Stem Leg					\$ 6,786	Two edge profiles available:  	
	PD-CG48-PN-S	Pencil Edge; Square & Stem Leg					\$ 6,786		
	PD-CG48-AC-R	Acrylic Edge; Dia. & Stem Leg					\$ 6,602		
PD-CG48-AC-S	Acrylic Edge; Square & Stem Leg					\$ 6,602			
	6 PERSON UNIT: 60" Depth;	108"	60"	29"				Model "PN"      Model "AC"	
	PD-CG60-PN-R	Pencil Edge; Dia. & Stem Leg					\$ 8,302	2" Pencil Edge      2 mm Acrylic Edge	
	PD-CG60-PN-S	Pencil Edge; Square & Stem Leg					\$ 8,302		
	PD-CG60-AC-R	Acrylic Edge; Dia. & Stem Leg					\$ 8,118		
PD-CG60-AC-S	Acrylic Edge; Square & Stem Leg					\$ 8,118	There is an option for a Grommet and Wire Management leg for this table. In addition to the above, there is also a 1/2" thick frosted acrylic divider screen with courtesy shelf option available for this table.		
	6 PERSON UNIT: 48" Depth;	96"	48"	29"				There are two different leg styles available:  	
	6 Grommets;								Model "R"
	2 Wire Management Legs;								2 1/2" Diameter & Stem Leg
	PD-CG48-PN-R-GW	Pencil Edge; Dia. & Stem Leg					\$ 7,611		Model "S"
PD-CG48-PN-S-GW	Pencil Edge; Square & Stem Leg					\$ 7,611	2" Square & Stem Leg		
PD-CG48-AC-R-GW	Acrylic Edge; Dia. & Stem Leg					\$ 7,428			
PD-CG48-AC-S-GW	Acrylic Edge; Square & Stem Leg					\$ 7,428			
	6 PERSON UNIT: 60" Depth;	108"	60"	29"					
	6 Grommets;								
	2 Wire Management Legs;								
	PD-CG60-PN-R-GW	Pencil Edge; Dia. & Stem Leg					\$ 9,126		
PD-CG60-PN-S-GW	Pencil Edge; Square & Stem Leg					\$ 9,126			
PD-CG60-AC-R-GW	Acrylic Edge; Dia. & Stem Leg					\$ 8,252			
PD-CG60-AC-S-GW	Acrylic Edge; Square & Stem Leg					\$ 8,252			



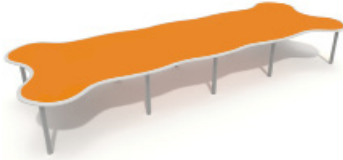

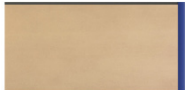
MODEL NUMBER	PRODUCT	WIDTH	DEPTH	HEIGHT	WEIGHT	VOLUME	LIST PRICE	DESCRIPTION
	6 PERSON UNIT: 48" Depth; 6 Grommets; 2 Wire Management Legs; Acrylic Dividers with top Shelf;	96"	48"	29"				Each unit is a six person unit.
	PD-CG48-PN-R-GWA Pencil Edge; Dia. & Stem Leg						\$ 9,033	Two edge profiles available:  Model "PN" 2" Pencil Edge      Model "AC" 2 mm Acrylic Edge  There is an option for a Grommet and Wire Management leg for this table. In addition to the above, there is also a 1/2" thick frosted acrylic divider screen with courtesy shelf option available for this table.  There are two different leg styles available:  Model "R" 2 1/2" Diameter & Stem Leg      Model "S" 2" Square & Stem Leg
	PD-CG48-PN-S-GWA Pencil Edge; Square & Stem Leg						\$ 9,033	
	PD-CG48-AC-R-GWA Acrylic Edge; Dia. & Stem Leg						\$ 8,849	
PD-CG48-AC-S-GWA Acrylic Edge; Square & Stem Leg						\$ 8,849		
	6 PERSON UNIT: 60" Depth; 6 Grommets; 2 Wire Management Legs; Acrylic Dividers with top Shelf;	108"	60"	29"				
	PD-CG60-PN-R-GWA Pencil Edge; Dia. & Stem Leg						\$ 10,548	
	PD-CG60-PN-S-GWA Pencil Edge; Square & Stem Leg						\$ 10,548	
	PD-CG60-AC-R-GWA Acrylic Edge; Dia. & Stem Leg						\$ 9,674	
PD-CG60-AC-S-GWA Acrylic Edge; Square & Stem Leg						\$ 9,674		

MODEL NUMBER	PRODUCT	WIDTH	DEPTH	HEIGHT	WEIGHT	VOLUME	LIST PRICE	DESCRIPTION	
	8 PERSON UNIT: 48" Depth;	132"	48"	29"				Each unit is an eight person unit.	
	PD-CGB48-PN-R	Pencil Edge; Dia. & Stem Leg					\$ 10,681	Two edge profiles available:  	
	PD-CGB48-PN-S	Pencil Edge; Square & Stem Leg					\$ 10,681		
	PD-CGB48-AC-R	Acrylic Edge; Dia. & Stem Leg					\$ 10,393		
PD-CGB48-AC-S	Acrylic Edge; Square & Stem Leg					\$ 10,393			
	8 PERSON UNIT: 60" Depth;	144"	60"	29"				Model "PN"      Model "AC"	
	PD-CGB60-PN-R	Pencil Edge; Dia. & Stem Leg					\$ 13,642	2" Pencil Edge      2 mm Acrylic Edge	
	PD-CGB60-PN-S	Pencil Edge; Square & Stem Leg					\$ 13,642		
	PD-CGB60-AC-R	Acrylic Edge; Dia. & Stem Leg					\$ 13,354		
PD-CGB60-AC-S	Acrylic Edge; Square & Stem Leg					\$ 13,354	There is an option for a Grommet and Wire Management leg for this table. In addition to the above, there is also a 1/2" thick frosted acrylic divider screen with courtesy shelf option available for this table.		
	8 PERSON UNIT: 48" Depth;	132"	48"	29"				There are two different leg styles available:  	
	8 Grommets;								Model "R"
	4 Wire Management Legs;								2 1/2" Diameter & Stem Leg
	PD-CGB48-PN-R-GW	Pencil Edge; Dia. & Stem Leg					\$ 11,801		Model "S"
PD-CGB48-PN-S-GW	Pencil Edge; Square & Stem Leg					\$ 11,801	2" Square & Stem Leg		
PD-CGB48-AC-R-GW	Acrylic Edge; Dia. & Stem Leg					\$ 11,513			
PD-CGB48-AC-S-GW	Acrylic Edge; Square & Stem Leg					\$ 11,513			
	8 PERSON UNIT: 60" Depth;	144"	60"	29"					
	8 Grommets;								
	4 Wire Management Legs;								
	PD-CGB60-PN-R-GW	Pencil Edge; Dia. & Stem Leg					\$ 14,761		
PD-CGB60-PN-S-GW	Pencil Edge; Square & Stem Leg					\$ 14,761			
PD-CGB60-AC-R-GW	Acrylic Edge; Dia. & Stem Leg					\$ 14,473			
PD-CGB60-AC-S-GW	Acrylic Edge; Square & Stem Leg					\$ 14,473			



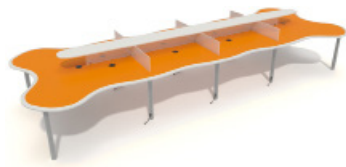



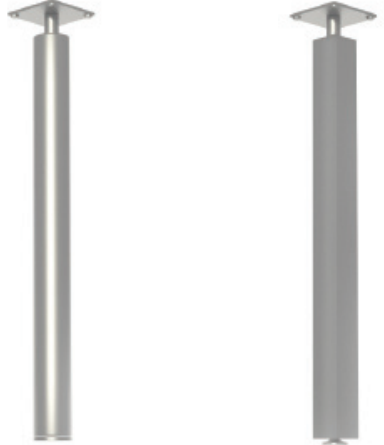

MODEL NUMBER	PRODUCT	WIDTH	DEPTH	HEIGHT	WEIGHT	VOLUME	LIST PRICE	DESCRIPTION
	8 PERSON UNIT: 48" Depth; 8 Grommets; 4 Wire Management Legs; Acrylic Dividers with top Shelf;	132"	48"	29"				Each unit is an eight person unit.
	PD-CGB48-PN-R-GWA Pencil Edge; Dia. & Stem Leg						\$ 13,806	Two edge profiles available:   Model "PN" 2" Pencil Edge      Model "AC" 2 mm Acrylic Edge  There is an option for a Grommet and Wire Management leg for this table. In addition to the above, there is also a 1/2" thick frosted acrylic divider screen with courtesy shelf option available for this table.
	PD-CGB48-PN-S-GWA Pencil Edge; Square & Stem Leg						\$ 13,806	
	PD-CGB48-AC-R-GWA Acrylic Edge; Dia. & Stem Leg						\$ 13,517	
PD-CGB48-AC-S-GWA Acrylic Edge; Square & Stem Leg						\$ 13,517		
	8 PERSON UNIT: 60" Depth; 8 Grommets; 4 Wire Management Legs; Acrylic Dividers with top Shelf;	144"	60"	29"				There are two different leg styles available:   Model "R" 2 1/2" Diameter & Stem Leg      Model "S" 2" Square & Stem Leg
	PD-CGB60-PN-R-GWA Pencil Edge; Dia. & Stem Leg						\$ 16,766	
	PD-CGB60-PN-S-GWA Pencil Edge; Square & Stem Leg						\$ 16,766	
	PD-CGB60-AC-R-GWA Acrylic Edge; Dia. & Stem Leg						\$ 16,477	
PD-CGB60-AC-S-GWA Acrylic Edge; Square & Stem Leg						\$ 16,477		

MODEL NUMBER	PRODUCT	WIDTH	DEPTH	HEIGHT	WEIGHT	VOLUME	LIST PRICE	DESCRIPTION	
	10 PERSON UNIT: 48" Depth;	168"	48"	29"				Each unit is a ten person unit.	
	PD-CGC48-PN-R	Pencil Edge; Dia. & Stem Leg					\$ 15,135	Two edge profiles available:  	
	PD-CGC48-PN-S	Pencil Edge; Square & Stem Leg					\$ 15,135		
	PD-CGC48-AC-R	Acrylic Edge; Dia. & Stem Leg					\$ 14,720		
PD-CGC48-AC-S	Acrylic Edge; Square & Stem Leg					\$ 14,720			
	10 PERSON UNIT: 60" Depth;	180"	60"	29"				Model "PN"      Model "AC"	
	PD-CGC60-PN-R	Pencil Edge; Dia. & Stem Leg					\$ 16,814	2" Pencil Edge      2 mm Acrylic Edge	
	PD-CGC60-PN-S	Pencil Edge; Square & Stem Leg					\$ 16,814		
	PD-CGC60-AC-R	Acrylic Edge; Dia. & Stem Leg					\$ 16,399		
PD-CGC60-AC-S	Acrylic Edge; Square & Stem Leg					\$ 16,399	There is an option for a Grommet and Wire Management leg for this table. In addition to the above, there is also a 1/2" thick frosted acrylic divider screen with courtesy shelf option available for this table.		
	10 PERSON UNIT: 48" Depth;	168"	48"	29"				There are two different leg styles available:  	
	10 Grommets;								Model "R"
	6 Wire Management Legs;								2 1/2" Diameter & Stem Leg
	PD-CGC48-PN-R-GW	Pencil Edge; Dia. & Stem Leg					\$ 16,549		Model "S"
PD-CGC48-PN-S-GW	Pencil Edge; Square & Stem Leg					\$ 16,549	2" Square & Stem Leg		
PD-CGC48-AC-R-GW	Acrylic Edge; Dia. & Stem Leg					\$ 16,133			
PD-CGC48-AC-S-GW	Acrylic Edge; Square & Stem Leg					\$ 16,133			
	10 PERSON UNIT: 60" Depth;	180"	60"	29"					
	10 Grommets;								
	6 Wire Management Legs;								
	PD-CGC60-PN-R-GW	Pencil Edge; Dia. & Stem Leg					\$ 18,229		
PD-CGC60-PN-S-GW	Pencil Edge; Square & Stem Leg					\$ 18,229			
PD-CGC60-AC-R-GW	Acrylic Edge; Dia. & Stem Leg					\$ 17,814			
PD-CGC60-AC-S-GW	Acrylic Edge; Square & Stem Leg					\$ 17,814			

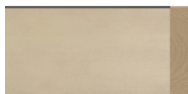







MODEL NUMBER	PRODUCT	WIDTH	DEPTH	HEIGHT	WEIGHT	VOLUME	LIST PRICE	DESCRIPTION
	10 PERSON UNIT: 48" Depth; 10 Grommets; 6 Wire Management Legs; Acrylic Dividers with top Shelf;	168"	48"	29"				Each unit is a ten person unit.
PD-CGC48-PN-R-GWA	Pencil Edge; Dia. & Stem Leg						\$ 19,060	Two edge profiles available:  Model "PN"      Model "AC" 2" Pencil Edge      2 mm Acrylic Edge
PD-CGC48-PN-S-GWA	Pencil Edge; Square & Stem Leg					\$ 19,060		
PD-CGC48-AC-R-GWA	Acrylic Edge; Dia. & Stem Leg					\$ 18,645		
PD-CGC48-AC-S-GWA	Acrylic Edge; Square & Stem Leg					\$ 18,645		
	10 PERSON UNIT: 60" Depth; 10 Grommets; 6 Wire Management Legs; Acrylic Dividers with top Shelf;	180"	60"	29"				There is an option for a Grommet and Wire Management leg for this table. In addition to the above, there is also a 1/2" thick frosted acrylic divider screen with courtesy shelf option available for this table.
PD-CGC60-PN-R-GWA	Pencil Edge; Dia. & Stem Leg						\$ 20,746	There are two different leg styles available:  Model "R"      Model "S" 2 1/2" Diameter      2" Square & Stem Leg      & Stem Leg
PD-CGC60-PN-S-GWA	Pencil Edge; Square & Stem Leg					\$ 20,746		
PD-CGC60-AC-R-GWA	Acrylic Edge; Dia. & Stem Leg					\$ 20,331		
PD-CGC60-AC-S-GWA	Acrylic Edge; Square & Stem Leg					\$ 20,331		









MODEL NUMBER	PRODUCT	WIDTH	DEPTH	HEIGHT	WEIGHT	VOLUME	LIST PRICE	DESCRIPTION
	ROUND Tables:							Each table is constructed of a 1" thick top with a plastic laminate top surface.
	36" Diameter;	36" Diameter		29"				There are three edge profiles available:
SO-R36-AC-ST	Acrylic Edge; Straight Leg						\$ 1,081	  
SO-R36-AC-WC	Acrylic Edge; Wave Caster Leg						\$ 1,547	
SO-R36-AC-WF	Acrylic Edge; Wave Fixed Leg						\$ 1,158	
SO-R36-BN-ST	Bullnose Edge; Straight Leg						\$ 1,323	<p>Model "AC" Acrylic Edge</p> <p>Model "BN" 3/4 Bullnose Edge</p> <p>Model "SQ" 1/4 Square Edge</p>
SO-R36-BN-WC	Bullnose Edge; Wave Caster Leg						\$ 1,780	
SO-R36-BN-WF	Bullnose Edge; Wave Fixed Leg						\$ 1,393	
SO-R36-SQ-ST	Square Edge; Straight Leg						\$ 1,236	<p>There are three different leg styles available:</p>   
SO-R36-SQ-WC	Square Edge; Wave Caster Leg						\$ 1,695	
SO-R36-SQ-WF	Square Edge; Wave Fixed Leg						\$ 1,306	
	42" Diameter;	42" Diameter		29"				
SO-R42-AC-ST	Acrylic Edge; Straight Leg						\$ 1,151	
SO-R42-AC-WC	Acrylic Edge; Wave Caster Leg						\$ 1,617	
SO-R42-AC-WF	Acrylic Edge; Wave Fixed Leg						\$ 1,229	
SO-R42-BN-ST	Bullnose Edge; Straight Leg						\$ 1,431	
SO-R42-BN-WC	Bullnose Edge; Wave Caster Leg						\$ 1,889	
SO-R42-BN-WF	Bullnose Edge; Wave Fixed Leg						\$ 1,500	
SO-R42-SQ-ST	Square Edge; Straight Leg						\$ 1,329	
SO-R42-SQ-WC	Square Edge; Wave Caster Leg						\$ 1,795	
SO-R42-SQ-WF	Square Edge; Wave Fixed Leg						\$ 1,400	
	48" Diameter;	48" Diameter		29"				
SO-R48-AC-ST	Acrylic Edge; Straight Leg						\$ 1,236	
SO-R48-AC-WC	Acrylic Edge; Wave Caster Leg						\$ 1,703	
SO-R48-AC-WF	Acrylic Edge; Wave Fixed Leg						\$ 1,306	
SO-R48-BN-ST	Bullnose Edge; Straight Leg						\$ 1,547	
SO-R48-BN-WC	Bullnose Edge; Wave Caster Leg						\$ 2,014	
SO-R48-BN-WF	Bullnose Edge; Wave Fixed Leg						\$ 1,624	
SO-R48-SQ-ST	Square Edge; Straight Leg						\$ 1,439	
SO-R48-SQ-WC	Square Edge; Wave Caster Leg						\$ 1,897	
SO-R48-SQ-WF	Square Edge; Wave Fixed Leg						\$ 1,508	



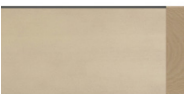



MODEL NUMBER	PRODUCT	WIDTH	DEPTH	HEIGHT	WEIGHT	VOLUME	LIST PRICE	DESCRIPTION
	ROUND Tables:							Each table is constructed of a 1" thick top with a plastic laminate top surface.
	54" Diameter;	54" Diameter		29"				There are three edge profiles available:
SO-R54-AC-ST	Acrylic Edge; Straight Leg						\$ 1,313	  
SO-R54-AC-WC	Acrylic Edge; Wave Caster Leg						\$ 1,772	
SO-R54-AC-WF	Acrylic Edge; Wave Fixed Leg						\$ 1,383	
SO-R54-BN-ST	Bullnose Edge; Straight Leg						\$ 1,710	  
SO-R54-BN-WC	Bullnose Edge; Wave Caster Leg						\$ 2,130	
SO-R54-BN-WF	Bullnose Edge; Wave Fixed Leg						\$ 1,741	
SO-R54-SQ-ST	Square Edge; Straight Leg						\$ 1,540	There are three different leg styles available:
SO-R54-SQ-WC	Square Edge; Wave Caster Leg						\$ 2,006	
SO-R54-SQ-WF	Square Edge; Wave Fixed Leg						\$ 1,610	
	60" Diameter;	60" Diameter		29"				
SO-R60-AC-ST	Acrylic Edge; Straight Leg						\$ 1,416	  
SO-R60-AC-WC	Acrylic Edge; Wave Caster Leg						\$ 1,873	
SO-R60-AC-WF	Acrylic Edge; Wave Fixed Leg						\$ 1,486	
SO-R60-BN-ST	Bullnose Edge; Straight Leg						\$ 1,804	
SO-R60-BN-WC	Bullnose Edge; Wave Caster Leg						\$ 2,263	
SO-R60-BN-WF	Bullnose Edge; Wave Fixed Leg						\$ 2,293	
SO-R60-SQ-ST	Square Edge; Straight Leg						\$ 1,664	
SO-R60-SQ-WC	Square Edge; Wave Caster Leg						\$ 2,130	
SO-R60-SQ-WF	Square Edge; Wave Fixed Leg						\$ 1,734	



MODEL NUMBER	PRODUCT	WIDTH	DEPTH	HEIGHT	WEIGHT	VOLUME	LIST PRICE	DESCRIPTION
	HALF ROUND Tables:							Each table is constructed of a 1" thick top with a plastic laminate top surface.
	48" Width;	48"	24"	29"				There are three edge profiles available:
SO-HR-4824-AC-ST	Acrylic Edge; Straight Leg						\$ 1,042	
SO-HR-4824-AC-WC	Acrylic Edge; Wave Caster Leg						\$ 1,508	
SO-HR-4824-AC-WF	Acrylic Edge; Wave Fixed Leg						\$ 1,119	
SO-HR-4824-BN-ST	Bullnose Edge; Straight Leg						\$ 1,212	
SO-HR-4824-BN-WC	Bullnose Edge; Wave Caster Leg						\$ 1,671	
SO-HR-4824-BN-WF	Bullnose Edge; Wave Fixed Leg						\$ 1,282	
SO-HR-4824-SQ-ST	Square Edge; Straight Leg						\$ 1,151	
SO-HR-4824-SQ-WC	Square Edge; Wave Caster Leg						\$ 1,617	
SO-HR-4824-SQ-WF	Square Edge; Wave Fixed Leg						\$ 1,220	
	54" Width;	54"	27"	29"				
SO-HR-5427-AC-ST	Acrylic Edge; Straight Leg						\$ 1,088	
SO-HR-5427-AC-WC	Acrylic Edge; Wave Caster Leg						\$ 1,555	
SO-HR-5427-AC-WF	Acrylic Edge; Wave Fixed Leg						\$ 1,166	
SO-HR-5427-BN-ST	Bullnose Edge; Straight Leg						\$ 1,275	
SO-HR-5427-BN-WC	Bullnose Edge; Wave Caster Leg						\$ 1,734	
SO-HR-5427-BN-WF	Bullnose Edge; Wave Fixed Leg						\$ 1,344	
SO-HR-5427-SQ-ST	Square Edge; Straight Leg						\$ 1,212	
SO-HR-5427-SQ-WC	Square Edge; Wave Caster Leg						\$ 1,671	
SO-HR-5427-SQ-WF	Square Edge; Wave Fixed Leg						\$ 1,282	
	60" Width;	60"	30"	29"				
SO-HR-6030-AC-ST	Acrylic Edge; Straight Leg						\$ 1,135	
SO-HR-6030-AC-WC	Acrylic Edge; Wave Caster Leg						\$ 1,602	
SO-HR-6030-AC-WF	Acrylic Edge; Wave Fixed Leg						\$ 1,212	
SO-HR-6030-BN-ST	Bullnose Edge; Straight Leg						\$ 1,344	
SO-HR-6030-BN-WC	Bullnose Edge; Wave Caster Leg						\$ 1,811	
SO-HR-6030-BN-WF	Bullnose Edge; Wave Fixed Leg						\$ 1,416	
SO-HR-6030-SQ-ST	Square Edge; Straight Leg						\$ 1,275	
SO-HR-6030-SQ-WC	Square Edge; Wave Caster Leg						\$ 1,734	
SO-HR-6030-SQ-WF	Square Edge; Wave Fixed Leg						\$ 1,344	

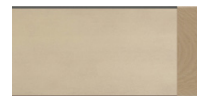







MODEL NUMBER	PRODUCT	WIDTH	DEPTH	HEIGHT	WEIGHT	VOLUME	LIST PRICE	DESCRIPTION
	QUARTER ROUND Tables:							Each table is constructed of a 1" thick top with a plastic laminate top surface.
	24" Width;	24"	24"	29"				There are three edge profiles available:
SO-QR-24-AC-ST	Acrylic Edge; Straight Leg						\$ 895	
SO-QR-24-AC-WC	Acrylic Edge; Wave Caster Leg						\$ 1,236	
SO-QR-24-AC-WF	Acrylic Edge; Wave Fixed Leg						\$ 949	
SO-QR-24-BN-ST	Bullnose Edge; Straight Leg						\$ 1,073	
SO-QR-24-BN-WC	Bullnose Edge; Wave Caster Leg						\$ 1,416	
SO-QR-24-BN-WF	Bullnose Edge; Wave Fixed Leg						\$ 1,119	
SO-QR-24-SQ-ST	Square Edge; Straight Leg						\$ 1,011	
SO-QR-24-SQ-WC	Square Edge; Wave Caster Leg						\$ 1,354	
SO-QR-24-SQ-WF	Square Edge; Wave Fixed Leg						\$ 1,058	
	30" Width;	30"	30"	29"				
SO-QR-30-AC-ST	Acrylic Edge; Straight Leg						\$ 941	
SO-QR-30-AC-WC	Acrylic Edge; Wave Caster Leg						\$ 1,290	
SO-QR-30-AC-WF	Acrylic Edge; Wave Fixed Leg						\$ 995	
SO-QR-30-BN-ST	Bullnose Edge; Straight Leg						\$ 1,166	
SO-QR-30-BN-WC	Bullnose Edge; Wave Caster Leg						\$ 1,508	
SO-QR-30-BN-WF	Bullnose Edge; Wave Fixed Leg						\$ 1,220	
SO-QR-30-SQ-ST	Square Edge; Straight Leg						\$ 1,088	
SO-QR-30-SQ-WC	Square Edge; Wave Caster Leg						\$ 1,431	
SO-QR-30-SQ-WF	Square Edge; Wave Fixed Leg						\$ 1,143	









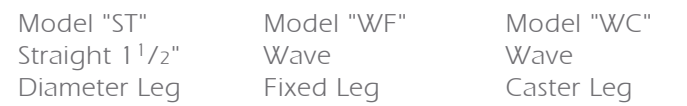

MODEL NUMBER	PRODUCT	WIDTH	DEPTH	HEIGHT	WEIGHT	VOLUME	LIST PRICE	DESCRIPTION
	SQUARE Tables:							Each table is constructed of a 1" thick top with a plastic laminate top surface.
	24" Width;	24"	24"	29"				There are three edge profiles available:
SO-2424-AC-ST	Acrylic Edge; Straight Leg						\$ 964	  
SO-2424-AC-WC	Acrylic Edge; Wave Caster Leg						\$ 1,431	
SO-2424-AC-WF	Acrylic Edge; Wave Fixed Leg						\$ 1,034	
SO-2424-BN-ST	Bullnose Edge; Straight Leg						\$ 1,166	  
SO-2424-BN-WC	Bullnose Edge; Wave Caster Leg						\$ 1,624	
SO-2424-BN-WF	Bullnose Edge; Wave Fixed Leg						\$ 1,236	
SO-2424-SQ-ST	Square Edge; Straight Leg						\$ 1,095	<p>There are three different leg styles available:</p>
SO-2424-SQ-WC	Square Edge; Wave Caster Leg						\$ 1,555	
SO-2424-SQ-WF	Square Edge; Wave Fixed Leg						\$ 1,166	
	30" Width;	30"	30"	29"				
SO-3030-AC-ST	Acrylic Edge; Straight Leg						\$ 1,019	  
SO-3030-AC-WC	Acrylic Edge; Wave Caster Leg						\$ 1,478	
SO-3030-AC-WF	Acrylic Edge; Wave Fixed Leg						\$ 1,088	
SO-3030-BN-ST	Bullnose Edge; Straight Leg						\$ 1,268	<p>Model "ST" Straight 1 1/2" Diameter Leg</p> <p>Model "WF" Wave Fixed Leg</p> <p>Model "WC" Wave Caster Leg</p>
SO-3030-BN-WC	Bullnose Edge; Wave Caster Leg						\$ 1,727	
SO-3030-BN-WF	Bullnose Edge; Wave Fixed Leg						\$ 1,336	
SO-3030-SQ-ST	Square Edge; Straight Leg						\$ 1,174	
SO-3030-SQ-WC	Square Edge; Wave Caster Leg						\$ 1,641	
SO-3030-SQ-WF	Square Edge; Wave Fixed Leg						\$ 1,244	









MODEL NUMBER	PRODUCT	WIDTH	DEPTH	HEIGHT	WEIGHT	VOLUME	LIST PRICE	DESCRIPTION	
RECTANGLE Tables, 24" Depth:									
	30" Width;	30"	24"	29"				Each table is constructed of a 1" thick top with a plastic laminate top surface.	
	SO-3024-AC-ST	Acrylic Edge; Straight Leg					\$ 988	There are three edge profiles available:   	
	SO-3024-AC-WC	Acrylic Edge; Wave Caster Leg					\$ 1,447		
	SO-3024-AC-WF	Acrylic Edge; Wave Fixed Leg					\$ 1,058		
	SO-3024-BN-ST	Bullnose Edge; Straight Leg					\$ 1,212	Model "AC" Acrylic Edge	
	SO-3024-BN-WC	Bullnose Edge; Wave Caster Leg					\$ 1,671		Model "BN" 3/4" Bullnose Edge
	SO-3024-BN-WF	Bullnose Edge; Wave Fixed Leg					\$ 1,282		
	SO-3024-SQ-ST	Square Edge; Straight Leg					\$ 1,135		
	SO-3024-SQ-WC	Square Edge; Wave Caster Leg					\$ 1,593		
	SO-3024-SQ-WF	Square Edge; Wave Fixed Leg					\$ 1,205		
	36" Width;	36"	24"	29"				There are three different leg styles available:	
	SO-3624-AC-ST	Acrylic Edge; Straight Leg					\$ 1,011		
	SO-3624-AC-WC	Acrylic Edge; Wave Caster Leg					\$ 1,469		
	SO-3624-AC-WF	Acrylic Edge; Wave Fixed Leg					\$ 1,081		
	SO-3624-BN-ST	Bullnose Edge; Straight Leg					\$ 1,259		
	SO-3624-BN-WC	Bullnose Edge; Wave Caster Leg					\$ 1,717		
	SO-3624-BN-WF	Bullnose Edge; Wave Fixed Leg					\$ 1,329		
	SO-3624-SQ-ST	Square Edge; Straight Leg					\$ 1,174		
	SO-3624-SQ-WC	Square Edge; Wave Caster Leg					\$ 1,633		
	SO-3624-SQ-WF	Square Edge; Wave Fixed Leg					\$ 1,244		
	42" Width;	42"	24"	29"					
	SO-4224-AC-ST	Acrylic Edge; Straight Leg					\$ 1,034	Model "ST" Straight 1 1/2" Diameter Leg	
	SO-4224-AC-WC	Acrylic Edge; Wave Caster Leg					\$ 1,493		
	SO-4224-AC-WF	Acrylic Edge; Wave Fixed Leg					\$ 1,105		
	SO-4224-BN-ST	Bullnose Edge; Straight Leg					\$ 1,306	Model "WF" Wave Fixed Leg	
	SO-4224-BN-WC	Bullnose Edge; Wave Caster Leg					\$ 1,765		
	SO-4224-BN-WF	Bullnose Edge; Wave Fixed Leg					\$ 1,375		
	SO-4224-SQ-ST	Square Edge; Straight Leg					\$ 1,212	Model "WC" Wave Caster Leg	
	SO-4224-SQ-WC	Square Edge; Wave Caster Leg					\$ 1,671		
	SO-4224-SQ-WF	Square Edge; Wave Fixed Leg					\$ 1,282		
	48" Width;	48"	24"	29"					
	SO-4824-AC-ST	Acrylic Edge; Straight Leg					\$ 1,058	Model "ST" Straight 1 1/2" Diameter Leg	
	SO-4824-AC-WC	Acrylic Edge; Wave Caster Leg					\$ 1,517		
	SO-4824-AC-WF	Acrylic Edge; Wave Fixed Leg					\$ 1,127		
	SO-4824-BN-ST	Bullnose Edge; Straight Leg					\$ 1,354	Model "WF" Wave Fixed Leg	
	SO-4824-BN-WC	Bullnose Edge; Wave Caster Leg					\$ 1,811		
	SO-4824-BN-WF	Bullnose Edge; Wave Fixed Leg					\$ 1,423		
	SO-4824-SQ-ST	Square Edge; Straight Leg					\$ 1,251	Model "WC" Wave Caster Leg	
	SO-4824-SQ-WC	Square Edge; Wave Caster Leg					\$ 1,710		
	SO-4824-SQ-WF	Square Edge; Wave Fixed Leg					\$ 1,323		

MODEL NUMBER	PRODUCT	WIDTH	DEPTH	HEIGHT	WEIGHT	VOLUME	LIST PRICE	DESCRIPTION
RECTANGLE Tables, 24" Depth:								
54" Width;								
	SO-5424-AC-ST	Acrylic Edge; Straight Leg	54"	24"			\$ 1,081	<p>Each table is constructed of a 1" thick top with a plastic laminate top surface.</p> <p>There are three edge profiles available:</p>  <p>Model "AC" Acrylic Edge      Model "BN" 3/4" Bullnose Edge      Model "SQ" 1/4" Square Edge</p> <p>There are three different leg styles available:</p>  <p>Model "ST" Straight 1 1/2" Diameter Leg      Model "WF" Wave Fixed Leg      Model "WC" Wave Caster Leg</p>
	SO-5424-AC-WC	Acrylic Edge; Wave Caster Leg					\$ 1,540	
	SO-5424-AC-WF	Acrylic Edge; Wave Fixed Leg					\$ 1,151	
	SO-5424-BN-ST	Bullnose Edge; Straight Leg					\$ 1,400	
	SO-5424-BN-WC	Bullnose Edge; Wave Caster Leg					\$ 1,865	
	SO-5424-BN-WF	Bullnose Edge; Wave Fixed Leg					\$ 1,469	
	SO-5424-SQ-ST	Square Edge; Straight Leg					\$ 1,282	
	SO-5424-SQ-WC	Square Edge; Wave Caster Leg					\$ 1,748	
	SO-5424-SQ-WF	Square Edge; Wave Fixed Leg					\$ 1,360	
60" Width;								
	SO-6024-AC-ST	Acrylic Edge; Straight Leg	60"	24"			\$ 1,105	
	SO-6024-AC-WC	Acrylic Edge; Wave Caster Leg					\$ 1,563	
	SO-6024-AC-WF	Acrylic Edge; Wave Fixed Leg					\$ 1,174	
	SO-6024-BN-ST	Bullnose Edge; Straight Leg					\$ 1,447	
	SO-6024-BN-WC	Bullnose Edge; Wave Caster Leg					\$ 1,912	
	SO-6024-BN-WF	Bullnose Edge; Wave Fixed Leg					\$ 1,517	
	SO-6024-SQ-ST	Square Edge; Straight Leg					\$ 1,323	
	SO-6024-SQ-WC	Square Edge; Wave Caster Leg					\$ 1,788	
	SO-6024-SQ-WF	Square Edge; Wave Fixed Leg					\$ 1,400	
72" Width;								
	SO-7224-AC-ST	Acrylic Edge; Straight Leg	72"	24"			\$ 1,143	
	SO-7224-AC-WC	Acrylic Edge; Wave Caster Leg					\$ 1,610	
	SO-7224-AC-WF	Acrylic Edge; Wave Fixed Leg					\$ 1,220	
	SO-7224-BN-ST	Bullnose Edge; Straight Leg					\$ 1,547	
	SO-7224-BN-WC	Bullnose Edge; Wave Caster Leg					\$ 2,006	
	SO-7224-BN-WF	Bullnose Edge; Wave Fixed Leg					\$ 1,617	
	SO-7224-SQ-ST	Square Edge; Straight Leg					\$ 1,400	
	SO-7224-SQ-WC	Square Edge; Wave Caster Leg					\$ 1,865	
	SO-7224-SQ-WF	Square Edge; Wave Fixed Leg					\$ 1,469	

MODEL NUMBER	PRODUCT	WIDTH	DEPTH	HEIGHT	WEIGHT	VOLUME	LIST PRICE	DESCRIPTION	
	RECTANGLE Tables, 30" Depth:							Each table is constructed of a 1" thick top with a plastic laminate top surface.	
		36" Width;	36"	30"	29"				There are three edge profiles available:
	SO-3630-AC-ST	Acrylic Edge; Straight Leg					\$ 1,042		
	SO-3630-AC-WC	Acrylic Edge; Wave Caster Leg					\$ 1,508		
	SO-3630-AC-WF	Acrylic Edge; Wave Fixed Leg					\$ 1,112		
									Model "AC" Acrylic Edge
	SO-3630-BN-ST	Bullnose Edge; Straight Leg					\$ 1,313		Model "BN" 3/4" Bullnose Edge
	SO-3630-BN-WC	Bullnose Edge; Wave Caster Leg					\$ 1,780		Model "SQ" 1/4" Square Edge
	SO-3630-BN-WF	Bullnose Edge; Wave Fixed Leg					\$ 1,393		
	SO-3630-SQ-ST	Square Edge; Straight Leg					\$ 1,220		
SO-3630-SQ-WC	Square Edge; Wave Caster Leg					\$ 1,680			
SO-3630-SQ-WF	Square Edge; Wave Fixed Leg					\$ 1,290			
	42" Width;	42"	30"	29"				There are three different leg styles available:	
SO-4230-AC-ST	Acrylic Edge; Straight Leg						\$ 1,073		
SO-4230-AC-WC	Acrylic Edge; Wave Caster Leg					\$ 1,531			
SO-4230-AC-WF	Acrylic Edge; Wave Fixed Leg					\$ 1,143			
SO-4230-BN-ST	Bullnose Edge; Straight Leg					\$ 1,369		Model "ST" Straight 1 1/2" Diameter Leg	
SO-4230-BN-WC	Bullnose Edge; Wave Caster Leg					\$ 1,827		Model "WF" Wave Fixed Leg	
SO-4230-BN-WF	Bullnose Edge; Wave Fixed Leg					\$ 1,439		Model "WC" Wave Caster Leg	
SO-4230-SQ-ST	Square Edge; Straight Leg					\$ 1,268			
SO-4230-SQ-WC	Square Edge; Wave Caster Leg					\$ 1,727			
SO-4230-SQ-WF	Square Edge; Wave Fixed Leg					\$ 1,336			
	48" Width;	48"	30"	29"					
SO-4830-AC-ST	Acrylic Edge; Straight Leg						\$ 1,095		
SO-4830-AC-WC	Acrylic Edge; Wave Caster Leg						\$ 1,563		
SO-4830-AC-WF	Acrylic Edge; Wave Fixed Leg						\$ 1,174		
SO-4830-BN-ST	Bullnose Edge; Straight Leg						\$ 1,423		
SO-4830-BN-WC	Bullnose Edge; Wave Caster Leg						\$ 1,881		
SO-4830-BN-WF	Bullnose Edge; Wave Fixed Leg						\$ 1,493		
SO-4830-SQ-ST	Square Edge; Straight Leg						\$ 1,306		
SO-4830-SQ-WC	Square Edge; Wave Caster Leg						\$ 1,765		
SO-4830-SQ-WF	Square Edge; Wave Fixed Leg						\$ 1,375		

MODEL NUMBER	PRODUCT	WIDTH	DEPTH	HEIGHT	WEIGHT	VOLUME	LIST PRICE	DESCRIPTION
	RECTANGLE Tables, 30" Depth:							Each table is constructed of a 1" thick top with a plastic laminate top surface.
	54" Width;	54"	30"	29"				There are three edge profiles available:
	SO-5430-AC-ST	Acrylic Edge; Straight Leg					\$ 1,127	
	SO-5430-AC-WC	Acrylic Edge; Wave Caster Leg					\$ 1,586	
	SO-5430-AC-WF	Acrylic Edge; Wave Fixed Leg					\$ 1,198	
	SO-5430-BN-ST	Bullnose Edge; Straight Leg					\$ 1,478	
	SO-5430-BN-WC	Bullnose Edge; Wave Caster Leg					\$ 1,935	
	SO-5430-BN-WF	Bullnose Edge; Wave Fixed Leg					\$ 1,547	
	SO-5430-SQ-ST	Square Edge; Straight Leg					\$ 1,354	
	SO-5430-SQ-WC	Square Edge; Wave Caster Leg					\$ 1,811	
SO-5430-SQ-WF	Square Edge; Wave Fixed Leg					\$ 1,423		
	60" Width;	60"	30"	29"				There are three different leg styles available:
SO-6030-AC-ST	Acrylic Edge; Straight Leg						\$ 1,158	
SO-6030-AC-WC	Acrylic Edge; Wave Caster Leg						\$ 1,617	
SO-6030-AC-WF	Acrylic Edge; Wave Fixed Leg						\$ 1,229	
SO-6030-BN-ST	Bullnose Edge; Straight Leg						\$ 1,524	
SO-6030-BN-WC	Bullnose Edge; Wave Caster Leg						\$ 1,989	
SO-6030-BN-WF	Bullnose Edge; Wave Fixed Leg						\$ 1,602	
SO-6030-SQ-ST	Square Edge; Straight Leg						\$ 1,393	
SO-6030-SQ-WC	Square Edge; Wave Caster Leg						\$ 1,858	
SO-6030-SQ-WF	Square Edge; Wave Fixed Leg						\$ 1,462	
	72" Width;	72"	30"	29"				
SO-7230-AC-ST	Acrylic Edge; Straight Leg						\$ 1,212	
SO-7230-AC-WC	Acrylic Edge; Wave Caster Leg						\$ 1,671	
SO-7230-AC-WF	Acrylic Edge; Wave Fixed Leg						\$ 1,282	
SO-7230-BN-ST	Bullnose Edge; Straight Leg						\$ 1,633	
SO-7230-BN-WC	Bullnose Edge; Wave Caster Leg						\$ 2,091	
SO-7230-BN-WF	Bullnose Edge; Wave Fixed Leg						\$ 1,703	
SO-7230-SQ-ST	Square Edge; Straight Leg						\$ 1,486	
SO-7230-SQ-WC	Square Edge; Wave Caster Leg						\$ 1,945	
SO-7230-SQ-WF	Square Edge; Wave Fixed Leg						\$ 1,555	

MODEL NUMBER	PRODUCT	WIDTH	DEPTH	HEIGHT	WEIGHT	VOLUME	LIST PRICE	DESCRIPTION	
	TRAPEZOIDAL Tables:							Each table is constructed of a 1" thick top with a plastic laminate top surface.	
		48" Width;	48"	21"	29"				There are three edge profiles available:
	SO-TZ-4821-AC-ST	Acrylic Edge; Straight Leg					\$ 1,034		
	SO-TZ-4821-AC-WC	Acrylic Edge; Wave Caster Leg				\$ 1,493			
	SO-TZ-4821-AC-WF	Acrylic Edge; Wave Fixed Leg				\$ 1,105			
									
	SO-TZ-4821-BN-ST	Bullnose Edge; Straight Leg				\$ 1,282			
	SO-TZ-4821-BN-WC	Bullnose Edge; Wave Caster Leg				\$ 1,741			
									
	SO-TZ-4821-BN-WF	Bullnose Edge; Wave Fixed Leg				\$ 1,354			
SO-TZ-4821-SQ-ST	Square Edge; Straight Leg				\$ 1,189				
SO-TZ-4821-SQ-WC	Square Edge; Wave Caster Leg				\$ 1,656				
SO-TZ-4821-SQ-WF	Square Edge; Wave Fixed Leg				\$ 1,259				
	54" Width;	54"	23"	29"				There are three different leg styles available:	
SO-TZ-5423-AC-ST	Acrylic Edge; Straight Leg					\$ 1,065			
SO-TZ-5423-AC-WC	Acrylic Edge; Wave Caster Leg				\$ 1,531				
SO-TZ-5423-AC-WF	Acrylic Edge; Wave Fixed Leg				\$ 1,143				
									
SO-TZ-5423-BN-ST	Bullnose Edge; Straight Leg				\$ 1,344				
SO-TZ-5423-BN-WC	Bullnose Edge; Wave Caster Leg				\$ 1,811				
									
SO-TZ-5423-BN-WF	Bullnose Edge; Wave Fixed Leg				\$ 1,416				
SO-TZ-5423-SQ-ST	Square Edge; Straight Leg				\$ 1,251				
SO-TZ-5423-SQ-WC	Square Edge; Wave Caster Leg				\$ 1,710				
SO-TZ-5423-SQ-WF	Square Edge; Wave Fixed Leg				\$ 1,323				
	60" Width;	60"	26"	29"					
SO-TZ-6026-AC-ST	Acrylic Edge; Straight Leg					\$ 1,119			
SO-TZ-6026-AC-WC	Acrylic Edge; Wave Caster Leg				\$ 1,578				
SO-TZ-6026-AC-WF	Acrylic Edge; Wave Fixed Leg				\$ 1,189				
									
SO-TZ-6026-BN-ST	Bullnose Edge; Straight Leg				\$ 1,431				
SO-TZ-6026-BN-WC	Bullnose Edge; Wave Caster Leg				\$ 1,889				
									
SO-TZ-6026-BN-WF	Bullnose Edge; Wave Fixed Leg				\$ 1,500				
SO-TZ-6026-SQ-ST	Square Edge; Straight Leg				\$ 1,423				
SO-TZ-6026-SQ-WC	Square Edge; Wave Caster Leg				\$ 1,780				
SO-TZ-6026-SQ-WF	Square Edge; Wave Fixed Leg				\$ 1,383				

MODEL NUMBER	PRODUCT	WIDTH	DEPTH	HEIGHT	WEIGHT	VOLUME	LIST PRICE	DESCRIPTION
	PUZZLE RIGHT Tables:							Each table is constructed of a 1" thick top with a plastic laminate top surface.
	60" Width	60"	36"	29"				There are three edge profiles available:
SO-PR-6036-AC-ST	Acrylic Edge; Straight Leg						\$ 1,212	
SO-PR-6036-AC-WC	Acrylic Edge; Wave Caster Leg						\$ 1,671	
SO-PR-6036-AC-WF	Acrylic Edge; Wave Fixed Leg						\$ 1,493	
SO-PR-6036-BN-ST	Bullnose Edge; Straight Leg						\$ 1,593	
SO-PR-6036-BN-WC	Bullnose Edge; Wave Caster Leg						\$ 2,053	
SO-PR-6036-BN-WF	Bullnose Edge; Wave Fixed Leg						\$ 1,664	
SO-PR-6036-SQ-ST	Square Edge; Straight Leg						\$ 1,454	
SO-PR-6036-SQ-WC	Square Edge; Wave Caster Leg						\$ 1,912	
SO-PR-6036-SQ-WF	Square Edge; Wave Fixed Leg						\$ 1,524	
	72" Width;	72"	36"	29"				There are three different leg styles available:
SO-PR-7236-AC-ST	Acrylic Edge; Straight Leg						\$ 1,275	
SO-PR-7236-AC-WC	Acrylic Edge; Wave Caster Leg						\$ 1,734	
SO-PR-7236-AC-WF	Acrylic Edge; Wave Fixed Leg						\$ 1,344	
SO-PR-7236-BN-ST	Bullnose Edge; Straight Leg						\$ 1,703	
SO-PR-7236-BN-WC	Bullnose Edge; Wave Caster Leg						\$ 2,169	
SO-PR-7236-BN-WF	Bullnose Edge; Wave Fixed Leg						\$ 1,780	
SO-PR-7236-SQ-ST	Square Edge; Straight Leg						\$ 1,555	
SO-PR-7236-SQ-WC	Square Edge; Wave Caster Leg						\$ 2,014	
SO-PR-7236-SQ-WF	Square Edge; Wave Fixed Leg						\$ 1,624	
	PUZZLE LEFT Tables:							
	60" Width;	60"	36"	29"				
SO-PL-6036-AC-ST	Acrylic Edge; Straight Leg						\$ 1,282	
SO-PL-6036-AC-WC	Acrylic Edge; Wave Caster Leg						\$ 1,671	
SO-PL-6036-AC-WF	Acrylic Edge; Wave Fixed Leg						\$ 1,282	
SO-PL-6036-BN-ST	Bullnose Edge; Straight Leg						\$ 1,593	
SO-PL-6036-BN-WC	Bullnose Edge; Wave Caster Leg						\$ 2,053	
SO-PL-6036-BN-WF	Bullnose Edge; Wave Fixed Leg						\$ 1,664	
SO-PL-6036-SQ-ST	Square Edge; Straight Leg						\$ 1,454	
SO-PL-6036-SQ-WC	Square Edge; Wave Caster Leg						\$ 1,912	
SO-PL-6036-SQ-WF	Square Edge; Wave Fixed Leg						\$ 1,524	
	72" Width;	72"	36"	29"				
SO-PL-7236-AC-ST	Acrylic Edge; Straight Leg						\$ 1,344	
SO-PL-7236-AC-WC	Acrylic Edge; Wave Caster Leg						\$ 1,734	
SO-PL-7236-AC-WF	Acrylic Edge; Wave Fixed Leg						\$ 1,344	
SO-PL-7236-BN-ST	Bullnose Edge; Straight Leg						\$ 1,710	
SO-PL-7236-BN-WC	Bullnose Edge; Wave Caster Leg						\$ 2,169	
SO-PL-7236-BN-WF	Bullnose Edge; Wave Fixed Leg						\$ 1,780	
SO-PL-7236-SQ-ST	Square Edge; Straight Leg						\$ 1,555	
SO-PL-7236-SQ-WC	Square Edge; Wave Caster Leg						\$ 2,014	
SO-PL-7236-SQ-WF	Square Edge; Wave Fixed Leg						\$ 1,624	



MODEL NUMBER	PRODUCT	WIDTH	DEPTH	HEIGHT	WEIGHT	VOLUME	LIST PRICE
CORNER WORKSTATIONS:							
42" Widths;							
SO-CWS-4224-AC-ST	Acrylic Edge; Straight Leg	42"	24"	29"			\$ 1,220
SO-CWS-4224-AC-WC	Acrylic Edge; Wave Caster Leg						\$ 1,795
SO-CWS-4224-AC-WF	Acrylic Edge; Wave Fixed Leg						\$ 1,306
SO-CWS-4224-BN-ST	Bullnose Edge; Straight Leg						\$ 1,547
SO-CWS-4224-BN-WC	Bullnose Edge; Wave Caster Leg						\$ 2,122
SO-CWS-4224-BN-WF	Bullnose Edge; Wave Fixed Leg						\$ 1,641
SO-CWS-4224-SQ-ST	Square Edge; Straight Leg						\$ 1,431
SO-CWS-4224-SQ-WC	Square Edge; Wave Caster Leg						\$ 2,006
SO-CWS-4224-SQ-WF	Square Edge; Wave Fixed Leg						\$ 1,524
42" Widths;							
SO-CWS-4230-AC-ST	Acrylic Edge; Straight Leg	42"	30"	29"			\$ 1,229
SO-CWS-4230-AC-WC	Acrylic Edge; Wave Caster Leg						\$ 1,804
SO-CWS-4230-AC-WF	Acrylic Edge; Wave Fixed Leg						\$ 1,313
SO-CWS-4230-BN-ST	Bullnose Edge; Straight Leg						\$ 1,555
SO-CWS-4230-BN-WC	Bullnose Edge; Wave Caster Leg						\$ 2,130
SO-CWS-4230-BN-WF	Bullnose Edge; Wave Fixed Leg						\$ 1,641
SO-CWS-4230-SQ-ST	Square Edge; Straight Leg						\$ 1,439
SO-CWS-4230-SQ-WC	Square Edge; Wave Caster Leg						\$ 2,014
SO-CWS-4230-SQ-WF	Square Edge; Wave Fixed Leg						\$ 1,524
48" Widths;							
SO-CWS-4824-AC-ST	Acrylic Edge; Straight Leg	48"	24"	29"			\$ 1,298
SO-CWS-4824-AC-WC	Acrylic Edge; Wave Caster Leg						\$ 1,873
SO-CWS-4824-AC-WF	Acrylic Edge; Wave Fixed Leg						\$ 1,393
SO-CWS-4824-BN-ST	Bullnose Edge; Straight Leg						\$ 1,671
SO-CWS-4824-BN-WC	Bullnose Edge; Wave Caster Leg						\$ 2,246
SO-CWS-4824-BN-WF	Bullnose Edge; Wave Fixed Leg						\$ 1,765
SO-CWS-4824-SQ-ST	Square Edge; Straight Leg						\$ 1,540
SO-CWS-4824-SQ-WC	Square Edge; Wave Caster Leg						\$ 2,115
SO-CWS-4824-SQ-WF	Square Edge; Wave Fixed Leg						\$ 1,633
48" Widths;							
SO-CWS-4830-AC-ST	Acrylic Edge; Straight Leg	48"	30"	29"			\$ 1,306
SO-CWS-4830-AC-WC	Acrylic Edge; Wave Caster Leg						\$ 1,881
SO-CWS-4830-AC-WF	Acrylic Edge; Wave Fixed Leg						\$ 1,393
SO-CWS-4830-BN-ST	Bullnose Edge; Straight Leg						\$ 1,680
SO-CWS-4830-BN-WC	Bullnose Edge; Wave Caster Leg						\$ 2,254
SO-CWS-4830-BN-WF	Bullnose Edge; Wave Fixed Leg						\$ 1,765
SO-CWS-4830-SQ-ST	Square Edge; Straight Leg						\$ 1,547
SO-CWS-4830-SQ-WC	Square Edge; Wave Caster Leg						\$ 2,122
SO-CWS-4830-SQ-WF	Square Edge; Wave Fixed Leg						\$ 1,633



Each table is constructed of a 1" thick top with a plastic laminate top surface.

There are three edge profiles available:



Model "AC" Acrylic Edge      Model "BN" 3/4" Bullnose Edge      Model "SQ" 1/4" Square Edge

There are three different leg styles available:



Model "ST" Straight 1 1/2" Diameter Leg      Model "WF" Wave Fixed Leg      Model "WC" Wave Caster Leg

Corner and Round Table Configurations:  
See appropriate table model matches, as shown below.

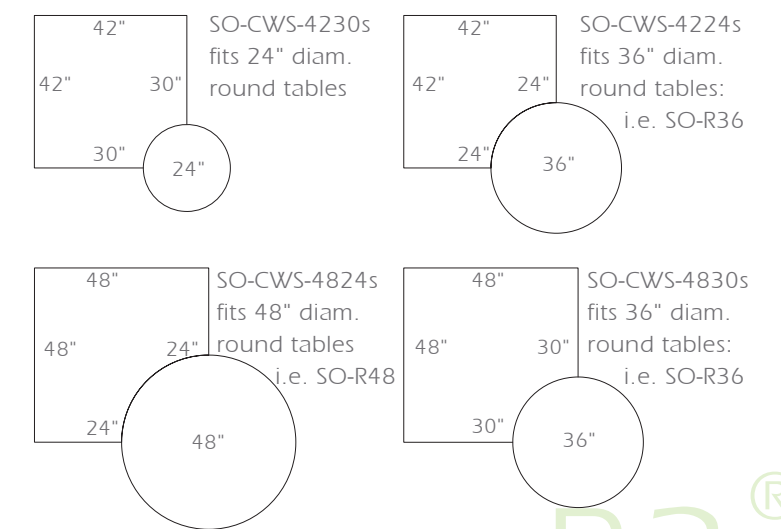

## CONFIGURATION A: CORNER WORKSTATIONS

4 - 42" Width Corner Workstations = 84" x 84"

4 - 48" Width Corner Workstations = 96" x 96"

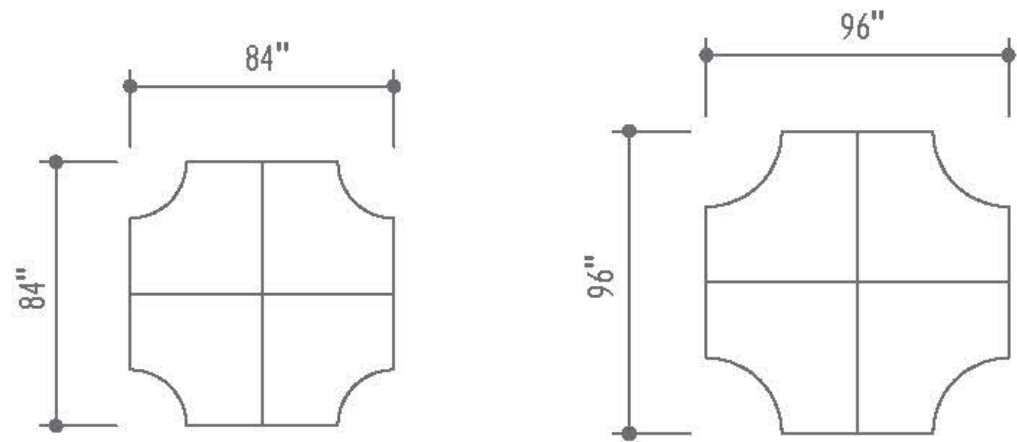

## CONFIGURATION B: CORNER & ROUND COMBO WORKSTATIONS

2 - 42" Width Corner Workstations (+) 1 - 24" or 36" Diameter Round Table = 54" x 84" or 60" x 84"

2 - 48" Width Corner Workstations (+) 1 - 48" or 36" Diameter Round Table = 72" x 96" or 66" x 96"

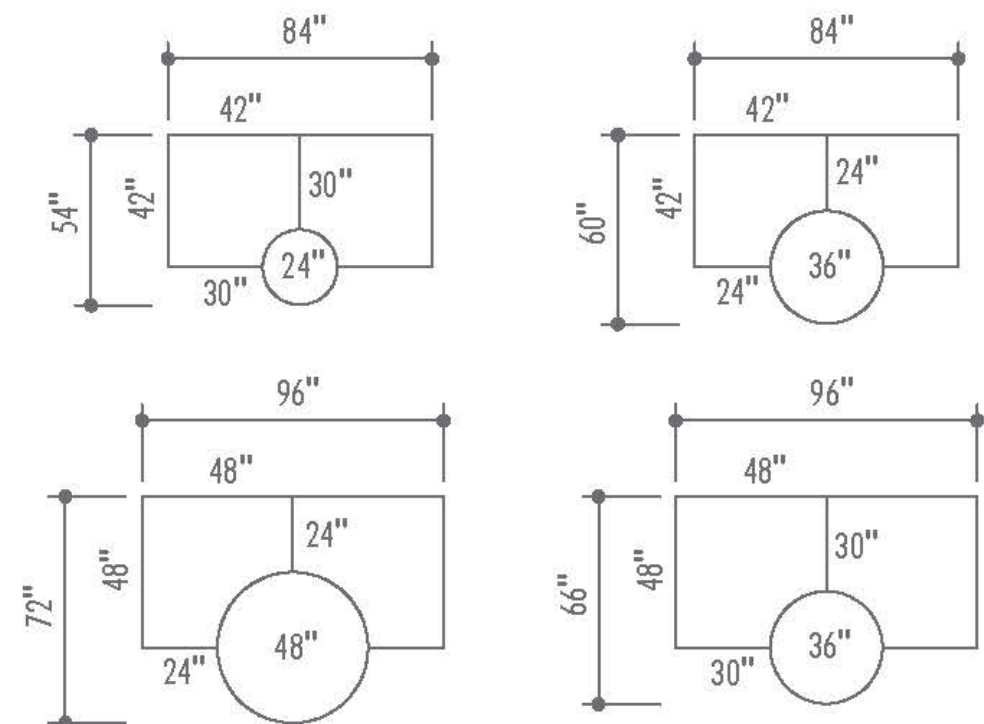

## CONFIGURATION C: RECTANGLE & HALF ROUND COMBO WORKSTATIONS

2 - 24" x 72" Rectangle Tables (+) 1 - 24" x 48" Half Round Table = 48" x 96"

2 - 30" x 72" Rectangle Tables (+) 1 - 30" x 60" Half Round Table = 60" x 102"

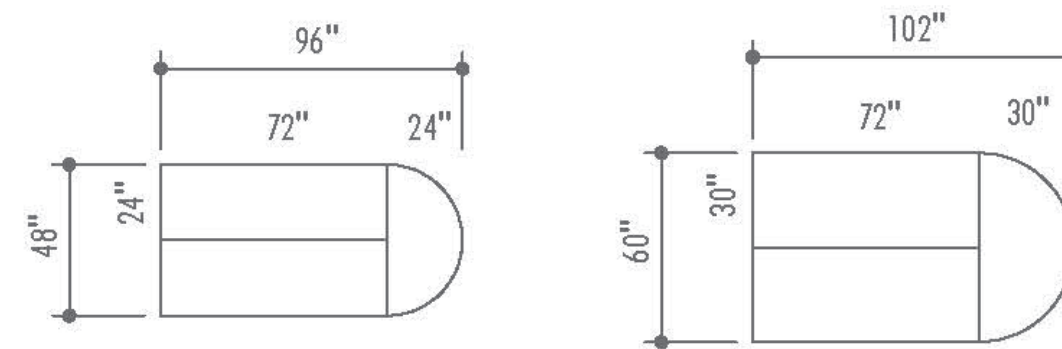



## CONFIGURATION D: TRAPEZOIDAL WORKSTATIONS

5 - 48" Width Trapezoidal Tables = 83" x 96"

5 - 54" Width Trapezoidal Tables = 93.5" x 108"

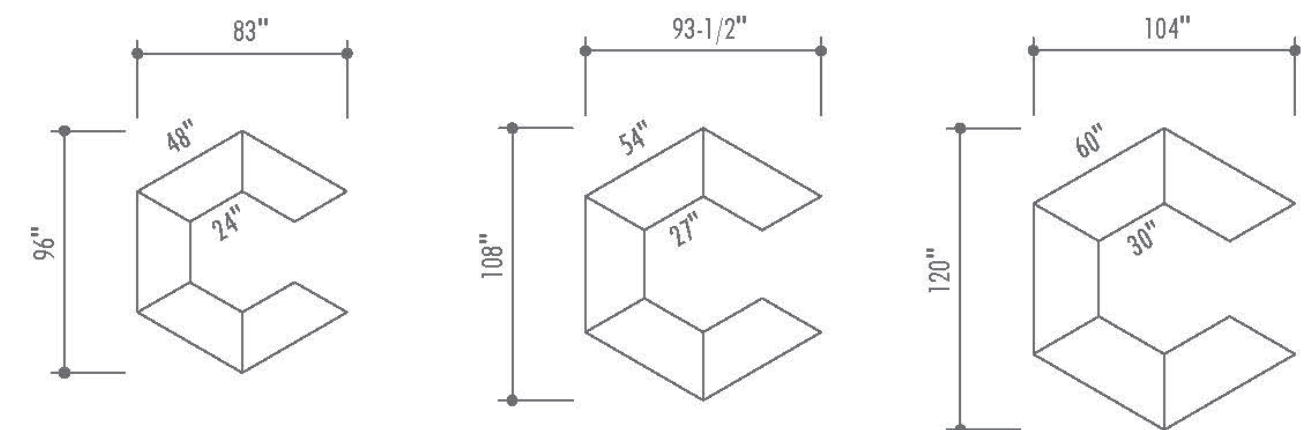



5 - 60" Width Trapezoidal Tables = 104" x 120"















MODEL NUMBER	PRODUCT	WIDTH	DEPTH	HEIGHT	WEIGHT	VOLUME	LIST PRICE	DESCRIPTION
	ROUND END Conference Tables:	72"	48"	29"				Each table is constructed of a 1" thick top with a plastic laminate top surface.
TE-RE-7248-AC-ST	Acrylic Edge; Straight Leg						\$ 2,122	There are three edge profiles available:
TE-RE-7248-AC-WC	Acrylic Edge; Wave Caster Leg					\$ 2,815		
TE-RE-7248-AC-WF	Acrylic Edge; Wave Fixed Leg					\$ 2,231		
TE-RE-7248-BN-ST	Bullnose Edge; Straight Leg						\$ 2,574	
TE-RE-7248-BN-WC	Bullnose Edge; Wave Caster Leg					\$ 3,265		
TE-RE-7248-BN-WF	Bullnose Edge; Wave Fixed Leg					\$ 2,682		
TE-RE-7248-SQ-ST	Square Edge; Straight Leg						\$ 2,417	There are three different leg styles available:
TE-RE-7248-SQ-WC	Square Edge; Wave Caster Leg					\$ 3,110		
TE-RE-7248-SQ-WF	Square Edge; Wave Fixed Leg					\$ 2,519		











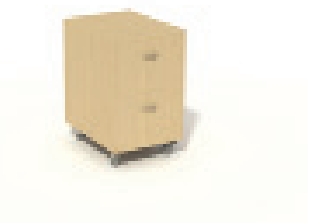

Model "ST" Straight 1 1/2" Diameter Leg      Model "WF" Wave Fixed Leg      Model "WC" Wave Caster Leg

	MODEL NUMBER	PRODUCT	WIDTH	DEPTH	HEIGHT	WEIGHT	VOLUME	LIST PRICE	DESCRIPTION	
		RECTANGLE Workstations, Acrylic Edge;							Each table is constructed of a 1" thick top with a plastic laminate top surface.	
	EO-3024-AC-WS	24" Depth	30"	24"	29"			\$ 1,493	There is one edge profile available:	
	EO-4824-AC-WS		48"	24"	29"			\$ 1,641		
	EO-6024-AC-WS		60"	24"	29"			\$ 1,703		
	EO-7224-AC-WS		72"	24"	29"			\$ 1,965		
	EO-4830-AC-WS	30" Depth	48"	30"	29"			\$ 1,680	 Model "AC" Acrylic Edge	
	EO-6030-AC-WS		60"	30"	29"			\$ 1,757		
	EO-7230-AC-WS		72"	30"	29"			\$ 2,029		
			CORNER Workstations, Acrylic Edge;							The T-Base is constructed of double support 1" x 2" tubular 16 gauge steel with a 3" wide perforated screen separation and an integrated modesty J-Channel for wire management. One 3" wide grommet at center. Model "TF" is T-Base Fixed, and "TC" is T-Base Caster.
		EO-C4224-AC-WS	24" Depth	42"	24"	29"			\$ 1,671	
	EO-C4830-AC-WS	30" Depth	48"	30"	29"			\$ 1,757		
		SQUARE Workstations, Acrylic Edge;								
	EO-2424-AC-WS	24" Width	24"	24"	29"			\$ 1,462		
	EO-3030-AC-WS	30" Width	30"	30"	29"			\$ 1,524		







	MODEL NUMBER	PRODUCT	WIDTH	DEPTH	HEIGHT	WEIGHT	VOLUME	LIST PRICE	DESCRIPTION
	TE-PDL-BBF-6030-AC-WC	BBF Pedestal, LEFT Desk: Acrylic Edge; Wave Caster	60"	30"	29"			\$ 4,392	<p>Each table is constructed of a 1" thick top with a plastic laminate top surface.</p> <p>There are three edge profiles available:</p>  <p>Model "AC" Acrylic Edge      Model "BN" 3/4" Bullnose Edge      Model "SQ" 1/4" Square Edge</p> <p>There is one leg styles available:</p>  <p>Model "WC" Wave Caster Leg</p>
	TE-PDL-BBF-6030-BN-WC	Bullnose Edge; Wave Caster						\$ 4,764	
	TE-PDL-BBF-6030-SQ-WC	Square Edge; Wave Caster						\$ 4,633	
	TE-PDL-BBF-7230-AC-WC	Acrylic Edge; Wave Caster	72"	30"	29"			\$ 4,453	
	TE-PDL-BBF-7230-BN-WC	Bullnose Edge; Wave Caster						\$ 4,875	
	TE-PDL-BBF-7230-SQ-WC	Square Edge; Wave Caster						\$ 4,718	
	TE-PDR-BBF-6030-AC-WC	BBF Pedestal, RIGHT Desk: Acrylic Edge; Wave Caster	60"	30"	29"			\$ 4,392	
	TE-PDR-BBF-6030-BN-WC	Bullnose Edge; Wave Caster						\$ 4,764	
	TE-PDR-BBF-6030-SQ-WC	Square Edge; Wave Caster						\$ 4,633	
	TE-PDR-BBF-7230-AC-WC	Acrylic Edge; Wave Caster	72"	30"	29"			\$ 4,453	
	TE-PDR-BBF-7230-BN-WC	Bullnose Edge; Wave Caster						\$ 4,875	
	TE-PDR-BBF-7230-SQ-WC	Square Edge; Wave Caster						\$ 4,718	
	TE-PDL-FF-6030-AC-WC	FF Pedestal, LEFT Desk: Acrylic Edge; Wave Caster	60"	30"	29"			\$ 4,385	
	TE-PDL-FF-6030-BN-WC	Bullnose Edge; Wave Caster						\$ 4,758	
	TE-PDL-FF-6030-SQ-WC	Square Edge; Wave Caster						\$ 4,626	
	TE-PDL-FF-7230-AC-WC	Acrylic Edge; Wave Caster	72"	30"	29"			\$ 4,439	
	TE-PDL-FF-7230-BN-WC	Bullnose Edge; Wave Caster						\$ 4,867	
	TE-PDL-FF-7230-SQ-WC	Square Edge; Wave Caster						\$ 4,712	
	TE-PDR-FF-6030-AC-WC	FF Pedestal, RIGHT Desk: Acrylic Edge; Wave Caster	60"	30"	29"			\$ 4,385	
	TE-PDR-FF-6030-BN-WC	Bullnose Edge; Wave Caster						\$ 4,758	
	TE-PDR-FF-6030-SQ-WC	Square Edge; Wave Caster						\$ 4,626	
	TE-PDR-FF-7230-AC-WC	Acrylic Edge; Wave Caster	72"	30"	29"			\$ 4,439	
	TE-PDR-FF-7230-BN-WC	Bullnose Edge; Wave Caster						\$ 4,867	
	TE-PDR-FF-7230-SQ-WC	Square Edge; Wave Caster						\$ 4,712	
	TE-FXB-7230-AC-WC	FF and BBF, Pedestal Desk Acrylic Edge; Wave Caster	72"	30"	29"			\$ 7,299	
	TE-FXB-7230-BN-WC	Bullnose Edge; Wave Caster						\$ 7,719	
	TE-FXB-7230-SQ-WC	Square Edge; Wave Caster						\$ 7,573	
	TE-D-BBF-7230-AC-WC	FF and BBF, Pedestal Desk Acrylic Edge; Wave Caster	72"	30"	29"			\$ 7,307	
	TE-D-BBF-7230-BN-WC	Bullnose Edge; Wave Caster						\$ 7,735	
	TE-D-BBF-7230-SQ-WC	Square Edge; Wave Caster						\$ 7,580	







	MODEL NUMBER	PRODUCT	WIDTH	DEPTH	HEIGHT	WEIGHT	VOLUME	LIST PRICE	DESCRIPTION
	TE-MS-AV-30	Audio Visual Cart: 2 Adjustable Shelves	36"	18"	30"			\$ 2,939	
	TE-MS-AV-30-LD	Audio Visual Cart: 2 Adjustable Shelves, Locking Doors	36"	18"	30"			\$ 3,141	
	TE-MS-WR-60	Mobile Wardrobe: Locking Cupboard, 1 File, 4 Adjustable Shelves	36"	24"	60"			\$ 3,506	
	TE-MS-WR-72	Mobile Wardrobe: Locking Cupboard, 2 File, 3 Adjustable Shelves	36"	24"	72"			\$ 3,824	
	TE-MS-SU-30-A	Mobile Support Unit: Locking Box and File, 2 Adjustable Shelves, Acrylic Screen	36"	24"	30"			\$ 3,639	



	MODEL NUMBER	PRODUCT	WIDTH	DEPTH	HEIGHT	WEIGHT	VOLUME	LIST PRICE	DESCRIPTION
	TE-MS-SU-30-B	Mobile Support Unit: Locking Box and File, 2 Pencil, Open Cubbie, Acrylic Screen	36"	24"	30"			\$ 3,794	
	TE-MS-S-28	Mobile Shelving: 2 Adjustable Shelves	18"	24"	28"			\$ 1,965	
	TE-MS-CB-28	Mobile Cupboard: 2 Adjustable Shelves, Locking Door	18"	24"	28"			\$ 2,473	
	TE-MS-BBF-28	Mobile Unit: Locking Pencil, Box, File	18"	24"	28"			\$ 3,265	
	TE-MS-FF-28	Mobile Unit: Locking 2 File	18"	24"	28"			\$ 3,258	



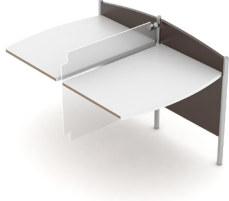



	MODEL NUMBER	PRODUCT	WIDTH	DEPTH	HEIGHT	WEIGHT	VOLUME	LIST PRICE	DESCRIPTION		
		WAVE II Single Face Carrels:							Carrel units have a 1/2" thick frosted acrylic back. Brushed stainless steel acrylic to post mount hardware.		
		Single STARTER Units;							Pole extension with courtesy shelf is available as well as optional wood back panels to replace the frost back panel that comes standard with each unit.		
	WC2-SS-36MC-AC	Acrylic Edge	38"	32"	29"/37"			\$ 3,468	There are three edge profiles available:   		
	WC2-SS-36MC-BN	Bullnose Edge						\$ 3,973			
	WC2-SS-36MC-MP	Multi-Ply Edge						\$ 3,389			
	WC2-SS-48MC-AC	Acrylic Edge	50"	32"	29"/37"			\$ 3,724			
	WC2-SS-48MC-BN	Bullnose Edge						\$ 4,222			
	WC2-SS-48MC-MP	Multi-Ply Edge						\$ 3,639			
		Single ADDER Units;									
	WC2-SA-36MC-AC	Acrylic Edge	36 1/2"	32"	29"/37"			\$ 3,016	Model "AC" Acrylic Edge		
	WC2-SA-36MC-BN	Bullnose Edge						\$ 3,739		Model "BN" 3/4" Bullnose Edge	
	WC2-SA-36MC-MP	Multi-Ply Edge						\$ 2,775			Model "MP" Exposed Multi-ply Core Edge
	WC2-SA-48MC-AC	Acrylic Edge	48 1/2"	32"	29"/37"			\$ 3,265			
	WC2-SA-48MC-BN	Bullnose Edge						\$ 3,987			
WC2-SA-48MC-MP	Multi-Ply Edge						\$ 3,188				
		2 Place Workstations, (Side By Side);									
	WC2-36W2-AC	Acrylic Edge	74"	32"	29"/37"			\$ 6,483			
	WC2-36W2-BN	Bullnose Edge						\$ 7,711			
	WC2-36W2-MP	Multi-Ply Edge						\$ 6,164			
	WC2-48W2-AC	Acrylic Edge	98"	32"	29"/37"			\$ 6,989			
	WC2-48W2-BN	Bullnose Edge						\$ 8,209			
WC2-48W2-MP	Multi-Ply Edge						\$ 6,826				



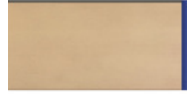
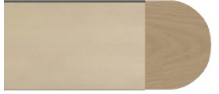

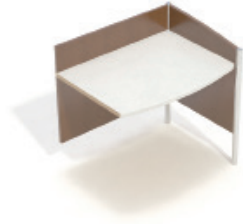







MODEL NUMBER	PRODUCT	WIDTH	DEPTH	HEIGHT	WEIGHT	VOLUME	LIST PRICE	DESCRIPTION
		WAVE II Single Face Carrels:						Carrel units have a 1/2" thick frosted acrylic back. Brushed stainless steel acrylic to post mount hardware.
3 Place Workstations, (Side By Side);								Pole extension with courtesy shelf is available as well as optional wood back panels to replace the frost back panel that comes standard with each unit.
WC2-36W3-AC WC2-36W3-BN WC2-36W3-MP	Acrylic Edge Bullnose Edge Multi-Ply Edge	110 1/2"	32"	29"/37"			\$ 9,499 \$ 11,449 \$ 8,940	There are three edge profiles available:
WC2-48W3-AC WC2-48W3-BN WC2-48W3-MP	Acrylic Edge Bullnose Edge Multi-Ply Edge	146 1/2"	32"	29"/37"			\$ 10,253 \$ 12,196 \$ 10,013	  
								Model "AC" Acrylic Edge
								Model "BN" 3/4" Bullnose Edge
								Model "MP" Exposed Multi-ply Core Edge
		4 Place Workstations, (Side By Side);						
WC2-36W4-AC WC2-36W4-BN WC2-36W4-MP	Acrylic Edge Bullnose Edge Multi-Ply Edge	147"	32"	29"/37"			\$ 12,515 \$ 15,189 \$ 11,715	
WC2-48W4-AC WC2-48W4-BN WC2-48W4-MP	Acrylic Edge Bullnose Edge Multi-Ply Edge	195"	32"	29"/37"			\$ 13,518 \$ 16,184 \$ 13,200	
		5 Place Workstations, (Side By Side);						
WC2-36W5-AC WC2-36W5-BN WC2-36W5-MP	Acrylic Edge Bullnose Edge Multi-Ply Edge	183 1/2"	32"	29"/37"			\$ 15,532 \$ 18,929 \$ 14,490	
WC2-48W5-AC WC2-48W5-BN WC2-48W5-MP	Acrylic Edge Bullnose Edge Multi-Ply Edge	243 1/2"	32"	29"/37"			\$ 16,783 \$ 20,172 \$ 16,386	

MODEL NUMBER	PRODUCT	WIDTH	DEPTH	HEIGHT	WEIGHT	VOLUME	LIST PRICE	DESCRIPTION
WAVE II Double Face Carrels:								Carrel units have a 1/2" thick frosted acrylic back. Brushed stainless steel acrylic to post mount hardware.
Double STARTER Units;								Pole extension with courtesy shelf is available as well as optional wood back panels to replace the frost back panel that comes standard with each unit.
	WC2-DS36-AC	Acrylic Edge	38"	62"	29"/37"		\$ 5,403	<p>There are three edge profiles available:</p>    <p>Model "AC" Acrylic Edge</p> <p>Model "BN" 3/4" Bullnose Edge</p> <p>Model "MP" Exposed Multi-ply Core Edge</p>
	WC2-DS36-BN	Bullnose Edge					\$ 6,297	
	WC2-DS36-MP	Multi-Ply Edge					\$ 5,239	
	WC2-DS48-AC	Acrylic Edge	50"	62"	29"/37"		\$ 5,651	
	WC2-DS48-BN	Bullnose Edge					\$ 6,546	
	WC2-DS48-MP	Multi-Ply Edge					\$ 5,488	
Double ADDER Units;								
	WC2-DA36-AC	Acrylic Edge	36 1/2"	62"	29"/37"		\$ 4,805	
	WC2-DA36-BN	Bullnose Edge					\$ 5,690	
	WC2-DA36-MP	Multi-Ply Edge					\$ 4,633	
	WC2-DA48-AC	Acrylic Edge	48 1/2"	62"	29"/37"		\$ 5,053	
	WC2-DA48-BN	Bullnose Edge					\$ 5,945	
	WC2-DA48-MP	Multi-Ply Edge					\$ 4,889	
4 Place Workstations, (2 Back to Back);								
	WC2-CB36-AC	Acrylic Edge	74"	62"	29"/37"		\$ 10,206	
	WC2-CB36-BN	Bullnose Edge					\$ 11,986	
	WC2-CB36-MP	Multi-Ply Edge					\$ 9,873	
	WC2-CB48-AC	Acrylic Edge	98"	62"	29"/37"		\$ 10,703	
	WC2-CB48-BN	Bullnose Edge					\$ 12,491	
	WC2-CB48-MP	Multi-Ply Edge					\$ 10,378	



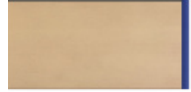
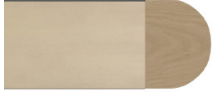

MODEL NUMBER	PRODUCT	WIDTH	DEPTH	HEIGHT	WEIGHT	VOLUME	LIST PRICE	DESCRIPTION	
		WAVE II Double Face Carrels:		Carrel units have a 1/2" thick frosted acrylic back. Brushed stainless steel acrylic to post mount hardware.					
6 Place Workstation (3 Back to Back);		Pole extension with courtesy shelf is available as well as optional wood back panels to replace the frost back panel that comes standard with each unit.							
WC2-CC36-AC	Acrylic Edge	110 1/2"	62"	29"/37"			\$ 15,011	<p>There are three edge profiles available:</p>    <p>Model "AC" Acrylic Edge    Model "BN" 3/4" Bullnose Edge    Model "MP" Exposed Multi-ply Core Edge</p>	
WC2-CC36-BN	Bullnose Edge						\$ 17,677		
WC2-CC36-MP	Multi-Ply Edge						\$ 14,506		
WC2-CC48-AC	Acrylic Edge	146 1/2"	62"	29"/37"			\$ 15,756		
WC2-CC48-BN	Bullnose Edge						\$ 18,439		
WC2-CC48-MP	Multi-Ply Edge						\$ 15,266		
		8 Place Workstation (4 Back to Back);							
WC2-CD36-AC	Acrylic Edge	147"	62"	29"/37"			\$ 19,813		
WC2-CD36-BN	Bullnose Edge						\$ 23,368		
WC2-CD36-MP	Multi-Ply Edge						\$ 19,139		
WC2-CD48-AC	Acrylic Edge	195"	62"	29"/37"			\$ 20,809		
WC2-CD48-BN	Bullnose Edge						\$ 24,385		
WC2-CD48-MP	Multi-Ply Edge						\$ 20,156		
		10 Place Workstation (5 Back to Back);							
WC2-CE36-AC	Acrylic Edge	183 1/2"	62"	29"/37"			\$ 24,618		
WC2-CE36-BN	Bullnose Edge						\$ 29,057		
WC2-CE36-MP	Multi-Ply Edge						\$ 23,770		
WC2-CE48-AC	Acrylic Edge	243 1/2"	62"	29"/37"			\$ 25,862		
WC2-CE48-BN	Bullnose Edge						\$ 30,332		
WC2-CE48-MP	Multi-Ply Edge						\$ 25,046		

MODEL NUMBER	PRODUCT	WIDTH	DEPTH	HEIGHT	WEIGHT	VOLUME	LIST PRICE	DESCRIPTION	
WAVE III Single Face Carrels:								Carrel units have a 1" thick veneer back instead of acrylic, with brushed stainless steel posts.	
Single STARTER Units;								Pole extension with courtesy shelf option is available for this unit also.	
	WC3-SS-36MC-AC	Acrylic Edge	38"	27 3/4"	29"/36"		\$ 2,370	<p>There are three edge profiles available:</p>    <p>Model "AC" Acrylic Edge    Model "BN" 3/4" Bullnose Edge    Model "MP" Exposed Multi-ply Core Edge</p>	
	WC3-SS-36MC-BN	Bullnose Edge					\$ 2,868		
	WC3-SS-36MC-MP	Multi-Ply Edge					\$ 2,286		
	WC3-SS-48MC-AC	Acrylic Edge	50"	27 3/4"	29"/36"		\$ 2,619		
	WC3-SS-48MC-BN	Bullnose Edge					\$ 3,125		
	WC3-SS-48MC-MP	Multi-Ply Edge					\$ 2,542		
Single ADDER Units;									
	WC3-SA-36MC-AC	Acrylic Edge	36 1/2"	27 3/4"	29"/36"		\$ 1,912		
	WC3-SA-36MC-BN	Bullnose Edge					\$ 2,636		
	WC3-SA-36MC-MP	Multi-Ply Edge					\$ 1,834		
	WC3-SA-48MC-AC	Acrylic Edge	48 1/2"	27 3/4"	29"/36"		\$ 2,169		
	WC3-SA-48MC-BN	Bullnose Edge					\$ 2,892		
	WC3-SA-48MC-MP	Multi-Ply Edge					\$ 2,083		
2 Place Workstations, (Side By Side);									
	WC3-36W2-AC	Acrylic Edge	74"	27 3/4"	29"/36"		\$ 4,283		
	WC3-36W2-BN	Bullnose Edge					\$ 5,504		
	WC3-36W2-MP	Multi-Ply Edge					\$ 4,120		
	WC3-48W2-AC	Acrylic Edge	98"	27 3/4"	29"/36"		\$ 4,789		
	WC3-48W2-BN	Bullnose Edge					\$ 6,017		
	WC3-48W2-MP	Multi-Ply Edge					\$ 4,626		





MODEL NUMBER	PRODUCT	WIDTH	DEPTH	HEIGHT	WEIGHT	VOLUME	LIST PRICE	DESCRIPTION
		WAVE III Single Face Carrels:		Carrel units have a 1" thick veneer back instead of acrylic, with brushed stainless steel posts.		Pole extension with courtesy shelf option is available for this unit also.		
3 Place Workstations, (Side By Side);								
WC3-36W3-AC WC3-36W3-BN WC3-36W3-MP	Acrylic Edge Bullnose Edge Multi-Ply Edge	110 1/2"	27 3/4"	29"/36"			\$ 6,195 \$ 8,139 \$ 5,956	
WC3-48W3-AC WC3-48W3-BN WC3-48W3-MP	Acrylic Edge Bullnose Edge Multi-Ply Edge	146 1/2"	27 3/4"	29"/36"			\$ 6,957 \$ 8,909 \$ 6,709	There are three edge profiles available:
								  
WC3-36W4-AC WC3-36W4-BN WC3-36W4-MP	Acrylic Edge Bullnose Edge Multi-Ply Edge	147"	27 3/4"	29"/36"			\$ 8,109 \$ 10,774 \$ 7,790	Model "AC" Acrylic Edge
WC3-48W4-AC WC3-48W4-BN WC3-48W4-MP	Acrylic Edge Bullnose Edge Multi-Ply Edge	195"	27 3/4"	29"/36"			\$ 9,126 \$ 11,801 \$ 8,792	Model "BN" 3/4" Bullnose Edge
								Model "MP" Exposed Multi-ply Core Edge
WC3-36W5-AC WC3-36W5-BN WC3-36W5-MP	Acrylic Edge Bullnose Edge Multi-Ply Edge	183"	27 3/4"	29"/36"			\$ 10,020 \$ 13,408 \$ 9,624	
WC3-48W5-AC WC3-48W5-BN WC3-48W5-MP	Acrylic Edge Bullnose Edge Multi-Ply Edge	243 1/2"	27 3/4"	29"/36"			\$ 11,294 \$ 14,691 \$ 10,874	





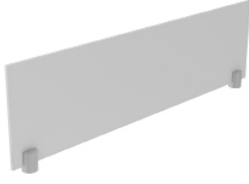

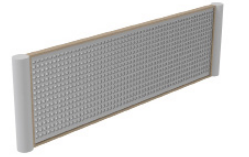
MODEL NUMBER	PRODUCT	WIDTH	DEPTH	HEIGHT	WEIGHT	VOLUME	LIST PRICE	DESCRIPTION
WAVE III Double Face Carrels:								Carrel units have a 1" thick veneer back instead of acrylic, with brushed stainless steel posts.
Double STARTER Units;								Pole extension with courtesy shelf option is available for this unit also.
	WC3-DS36-AC	38"	53 3/4"	29"/36"			\$ 4,339	There are three edge profiles available:
	WC3-DS36-BN						\$ 5,231	
	WC3-DS36-MP						\$ 4,175	
	WC3-DS48-AC	50"	53 3/4"	29"/36"			\$ 4,594	
	WC3-DS48-BN						\$ 5,480	
	WC3-DS48-MP						\$ 4,432	
	Double ADDER Units;							
	WC3-DA36-AC	36 1/2"	53 3/4"	29"/36"			\$ 3,732	 Model "AC" Acrylic Edge  Model "BN" 3/4" Bullnose Edge  Model "MP" Exposed Multi-ply Core Edge
	WC3-DA36-BN						\$ 4,626	
	WC3-DA36-MP						\$ 3,568	
	WC3-DA48-AC	48 1/2"	53 3/4"	29"/36"			\$ 3,980	
	WC3-DA48-BN						\$ 4,875	
WC3-DA48-MP	\$ 3,817							
	4 Place Workstations, (2 Back to Back);							
	WC3-CB36-AC	74"	53 3/4"	29"/36"			\$ 8,070	
	WC3-CB36-BN						\$ 9,857	
	WC3-CB36-MP						\$ 7,743	
	WC3-CB48-AC	98"	53 3/4"	29"/36"			\$ 8,574	
	WC3-CB48-BN						\$ 10,355	
WC3-CB48-MP	\$ 8,248							

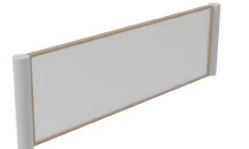



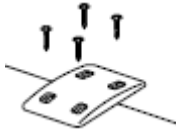

MODEL NUMBER	PRODUCT	WIDTH	DEPTH	HEIGHT	WEIGHT	VOLUME	LIST PRICE	DESCRIPTION
	WAVE III Double Face Carrels:							Carrel units have a 1" thick veneer back instead of acrylic, with brushed stainless steel posts.  Pole extension with courtesy shelf option is available for this unit also.
	6 Place Workstation (3 Back to Back);							
WC3-CC36-AC WC3-CC36-BN WC3-CC36-MP	Acrylic Edge Bullnose Edge Multi-Ply Edge	110 1/2"	53 3/4"	29"/36"			\$ 11,801 \$ 14,482 \$ 11,310	
WC3-CC48-AC WC3-CC48-BN WC3-CC48-MP	Acrylic Edge Bullnose Edge Multi-Ply Edge	146 1/2"	53 3/4"	29"/36"			\$ 12,555 \$ 15,228 \$ 12,065	There are three edge profiles available:
								  
								Model "AC" Acrylic Edge      Model "BN" 3/4" Bullnose Edge      Model "MP" Exposed Multi-ply Core Edge
	8 Place Workstation (4 Back to Back);							
WC3-CD36-AC WC3-CD36-BN WC3-CD36-MP	Acrylic Edge Bullnose Edge Multi-Ply Edge	147"	53 3/4"	29"/36"			\$ 15,532 \$ 19,107 \$ 14,879	
WC3-CD48-AC WC3-CD48-BN WC3-CD48-MP	Acrylic Edge Bullnose Edge Multi-Ply Edge	195"	53 3/4"	29"/36"			\$ 16,535 \$ 20,102 \$ 15,881	
	10 Place Workstation (5 Back to Back);							
WC3-CE36-AC WC3-CE36-BN WC3-CE36-MP	Acrylic Edge Bullnose Edge Multi-Ply Edge	183 1/2"	53 3/4"	29"/36"			\$ 19,264 \$ 23,731 \$ 18,446	
WC3-CE48-AC WC3-CE48-BN WC3-CE48-MP	Acrylic Edge Bullnose Edge Multi-Ply Edge	243 1/2"	53 3/4"	29"/36"			\$ 20,514 \$ 24,975 \$ 19,698	

	MODEL NUMBER	PRODUCT	WIDTH	DEPTH	HEIGHT	WEIGHT	VOLUME	LIST PRICE	DESCRIPTION
	WC-CS-FS	Frosted Acrylic Courtesy Shelf	16"	9"	1/2"	1 Lb.		\$ 420	Note: Pole Extension option is required for Wave Versions II and III, when ordering a Courtesy Shelf.
	WC-CS-FS-1	Frosted Glass Courtesy Shelf				1 Lbs.		\$ 483	
	WC-CS-OAK	Oak Wood Courtesy Shelf				2 Lbs.		\$ 397	
	WC-CS-MAPLE	Maple Wood Courtesy Shelf				2 Lbs.		\$ 397	
	WC-PE	Pole Extension			12"			\$ 296	This Pole Extension option is required when ordering a Courtesy Shelf Option for Wave Versions II and III.  NOTE: It must be indicated which Pole on the unit is to be extended. Plan layout required.
	WC-WBO38-OAK	1/2" Oak Wood Back Panel Option in Lieu of Frosted	34 1/2"	1/2"	36"	15 Lbs.		\$ 536	
	WC-WBO50-OAK		46 1/2"	1/2"	36"	22 Lbs.		\$ 560	
	WC-WBO38-MAPLE	1/2" Maple Wood Back Panel Option in Lieu of Frosted	34 1/2"	1/2"	36"	15 Lbs.		\$ 536	
	WC-WBO50-MAPLE		46 1/2"	1/2"	36"	22 Lbs.		\$ 560	



	MODEL NUMBER	PRODUCT	WIDTH	DEPTH	HEIGHT	WEIGHT	VOLUME	LIST PRICE	DESCRIPTION
	S-FA-S	Frosted Acrylic Screen - Small	20"		8"	2.5 Lbs.	0.5 Cu Ft	\$ 412	
	S-FA-L	Frosted Acrylic Screen - Large	32"		8"	2.5 Lbs.	0.5 Cu Ft	\$ 436	
	S-FAS	Frosted Acrylic Screen Surround	32"	13"	8"	9.5 Lbs.	0.5 Cu Ft	\$ 846	
	S-WS	Wood Screen Surround	32"	7"	8"	8 Lbs. 8 Lbs.	0.5 Cu Ft 0.5 Cu Ft	\$ 420	
	S-SWM-S	Wood Frame Perforated Metal Screen - Small	20"		8"			\$ 777	
	S-SWM-L	Wood Frame Perforated Metal Screen - Large	32"		16"			\$ 1,158	
	S-SWW-S	Wood Screen, Metal Posts - Small	20"		8"			\$ 513	
	S-SWW-L	Wood Screen, Metal Posts - Large	32"		16"			\$ 770	
	S-SWA	Wood Frame, Metal Posts, Frosted Acrylic Screen	24"		16"			\$ 1,158	

	MODEL NUMBER	PRODUCT	WIDTH	DEPTH	HEIGHT	WEIGHT	VOLUME	LIST PRICE	DESCRIPTION
	PD-BL	Pencil Drawer	20 <sup>7</sup> / <sub>8</sub> "	18 <sup>1</sup> / <sub>2</sub> "	1 <sup>7</sup> / <sub>8</sub> "			\$ 217	Pencil & paper drawer. Includes roller slides and frame for under-desk mounting. Black finish.
	CD-250-PK	Pullout Keyboard	24"	11"				\$ 793	
	CD-250-AK	Articulating Keyboard and Mouse	21"	10"				\$ 793	
	PW-G2D	Plastic Grommet 2"	2"	2"	<sup>3</sup> / <sub>4</sub> "	0.1 Lb.		\$ 131	
	PW-G3D	Plastic Grommet 3"	3"	3"	<sup>3</sup> / <sub>4</sub> "	0.1 Lb.		\$ 131	
	P-TC-V	Vertical Flex Wire Leg	3"	2"	32 <sup>1</sup> / <sub>2</sub> "			\$ 256	32 <sup>1</sup> / <sub>2</sub> " Silver Plastic. Separates wire in different channels for easier maintenance. Kit includes: 1 top bracket, 15 spine wheels, 2 fixing clips for horizontal applications and 1 weighted base. Also comes in Black.
	P-TC	Table Connector	3"	2"				\$ 63	
	PW-OWMT-30	Wire Manager	30"	2"				\$ 131	

	MODEL NUMBER	PRODUCT	WIDTH	DEPTH	HEIGHT	WEIGHT	VOLUME	LIST PRICE	DESCRIPTION
	PW-100F	Flip-Up Power Station 2 outlet, 2 data	9	5 <sup>3</sup> / <sub>8</sub> "	5 <sup>1</sup> / <sub>2</sub> "			\$ 831	Black Metal
	DTP-BL	Desktop Power and Data	7"		3"			\$ 359	Black Plastic
	PW-PS-HB PW-PDS-HB	Power Sphere - Black 3 outlets 2 outlets, 1 Dual USB port	3" 3"		3" 3"			\$ 413 \$ 496	Black Plastic
	PW-PS-HW PW-PDS-HW	Power Sphere - White 3 outlets 2 outlets, 1 Dual USB port	3" 3"		3" 3"			\$ 413 \$ 496	White Plastic
	PW-600-INS-2P PW-600-INS-1P-1U PW-600-INS-3P PW-600-INS-2P-1U PW-600-INS-5P PW-600-INS-3P-2U	In-Surface Power - White 2 outlets 1 outlet, 1 Dual USB port 3 outlets 2 outlets, 1 Dual USB port 5 outlets 3 outlets, 2 Dual USB ports	5" 5" 6" 6" 9" 9"	2" 2" 2" 2" 2" 2"				\$ 536 \$ 634 \$ 565 \$ 668 \$ 779 \$ 826	White Plastic
	PW-SPC-4 PW-SPC-6	Power Bar 4 Outlets 6 Outlets	12" 15"	2" 2"	1" 1"			\$ 194 \$ 194	White Plastic - 15 amp 120V
	VD-LT-24 VD-LT-36 VD-LT-48	LED Round Rail Light 24" Length 36" Length 48" Length	23 <sup>3</sup> / <sub>4</sub> " 35 <sup>3</sup> / <sub>4</sub> " 47 <sup>3</sup> / <sub>4</sub> "			1 Lbs 1 Lbs	0.1 Cu.Ft 0.1 Cu.Ft	Inquire for Quote	Three different LED light fixtures are available in a race (round) rail shape and sold separately. 3 Rail Length Sizes to choose from: 1) 23 <sup>3</sup> / <sub>4</sub> " 2) 35 <sup>3</sup> / <sub>4</sub> " 3) 47 <sup>3</sup> / <sub>4</sub> " This is an extruded aluminum fixture that have a slim and minimal profile. Ideal for tables, workstations, and carrel desks in corporate, library and educational settings.

Palmieri Furniture Limited ("Palmieri") warrants that its products and collections are free from defects in materials and workmanship for the life of the product, except as set forth below. Palmieri Limited Lifetime Warranty is valid from the date of delivery.

**Exceptions to the Limited Lifetime Warranty: Seating: two (2) years**

Goods sold hereunder are covered by a Limited Lifetime Warranty, free against defects in material and workmanship provided the goods and services are subjected to normal use and service. The applicable warranty period commences from shipping date to Purchaser of any item of the goods, whichever occurs first, or any other warranty period otherwise stipulated in writing by Palmieri under this sale. For components not supplied by Palmieri, the original manufacturer's warranty shall apply to the extent assignable by Palmieri. The obligation under this warranty is limited to the repair or replacement, at Palmieri's option, of defective parts F.O.B. point of shipment provided that prompt notice of any defect is given by Purchaser to Palmieri in writing within the applicable warranty period and that upon the Purchaser's return of the defective parts to Palmieri or, if designated by Palmieri, to the location where the works are made, properly packed and with transportation charges prepaid by Purchaser, an inspection thereof shall reveal to Palmieri's satisfaction that Purchaser's claim is valid under the terms of this warranty. Purchaser shall assume all responsibility and expense for dismantling, removal, re-installation and freight in connection with the foregoing. The same obligations and conditions extend to replacement parts furnished by Palmieri hereunder.

Palmieri does not assume liability for installation, labour or consequential damages. Palmieri makes no warranty other than the one set forth herein. All other warranties, legal, expressed or implied, including but not limited to any expressed or implied warranty of merchantability, of fitness for the intended use thereof or against infringement are hereby expressly excluded. The applicable warranty ceases to be effective if the goods are altered or repaired other than by persons authorized or approved by Palmieri to perform such work. Repairs or replacement deliveries do not interrupt or prolong the term of the warranty. The warranty ceases to be effective if Purchaser fails to handle and use the goods sold hereunder in a safe and reasonable manner and in accordance with any written instructions from the manufacturers.

**Warranty Does Not Apply To Product Failure Or Loss Resulting From:**

Abuse, misuse or accident, alteration or modification of product by customer or third party, normal wear and tear, improper installation, handling or incorrect use. The substitution of part components or hardware not approved or authorized by Palmieri, acts of God, unauthorized repairs, improper storage, and environmental conditions such as irregular temperature control either inside or outside the environment.

**Warranty Provides Exclusive Remedies:**

If a product fails under ordinary use as a result of a defect in material or workmanship, Palmieri will: (A) repair, or (B) replace the furniture. The replacement or repair of the Furniture or Seating will be at the discretion of Palmieri. If the defect or workmanship cannot be remedied on site, repairs can be made at the factory. (C) If the product repair or replacement is not commercially practicable or cannot be remade in a timely manner Palmieri will refund the purchase price of the affected product. A product "**Defect**" means: an inadequacy in the materials or workmanship of the product that (A) existed at the time when you received the product from Palmieri or Palmieri authorized Reseller and (B) causes a failure of the product to perform under ordinary use in accordance with the materials and documentation accompanying the product. "**Ordinary Use**" means: use of the product (A) in accordance with all applicable local, state or federal laws, codes and regulations and (B) in accordance with manufacturer recommendations and or instructions in the materials and documentation accompanying the product or through shop drawings. A "**Palmieri Authorized Reseller**" means: any dealer that is legally permitted to conduct business in the jurisdiction where the product is sold and is duly authorized by Palmieri to sell the product.

Warranty work must be approved by authorized personnel of Palmieri Furniture Limited in Richmond Hill, Ontario, Canada.

**A copy of the original purchase order must accompany all claims.**

**Warranty Does Not Cover:**

Matching of colours, stains, textures, grains and any other variations in materials. Select and Custom Surfaces and materials are only warranted for their application on the specified product and are not covered by our warranty, except as warranted by the original supplier, for quality, colorfastness, shade variations or abrasion and textiles purchased for Palmieri product.

**This limited warranty is the sole remedy for product defect and no other express or implied warranty is provided. Warranty is not transferable and valid only for the original purchaser acquiring a product from Palmieri or a Palmieri authorized reseller for the purchaser's own use and not for resale, remarketing or distribution. Limited Lifetime Warranty (25 years)**

**GENERAL**

The following Terms and Conditions of Quote and Sale shall apply to any sale of goods and services by Palmieri Furniture Limited (hereinafter called "Palmieri"). Purchaser shall be deemed to have full knowledge of the terms and conditions herein and such terms and conditions shall be binding if either the goods and services referred to herein are delivered to and accepted by Purchaser, or if Purchaser does not within five (5) days from the date hereof deliver to Palmieri written objection to said terms and conditions or any part thereof.

In the event of any conflict or inconsistency between the terms and conditions of sale herein and the terms and conditions contained in Purchaser's order or in any other form issued by Purchaser, whether or not any such form has been acknowledged or accepted by Palmieri, Palmieri's terms and conditions herein shall prevail. No waiver, alteration or modification of these terms and conditions shall be binding upon Palmieri unless made in writing and signed by a duly authorized representative of Palmieri.

**1. QUOTATIONS / PRODUCT QUOTED**

Unless otherwise stated, **Palmieri's quotations shall be null and void unless accepted by Purchaser within thirty (30) days from the date of quotation.** Quotes may be subject to change before order placement, due to increased material costs and or other factors that could impact the final cost of production and our final understanding of the product required. If the items quoted do not reflect the intended product requirements of the customer, Palmieri will not be held responsible for increased costs for those product changes. We reserve the right to edit or re-quote any portion of a previously submitted quotation subject to our final understanding of the product required by the client.

**2. PALMIERI DRAWINGS**

Palmieri provides drawings for Custom & Standard product we produce to our clients upon request. We consider these drawings to be Private and Confidential and are provided for the sole purpose and use of our clients to understand the product we are providing. The use of these confidential materials is limited to the transaction between the parties and at no point are these confidential materials to be sent to any of our competitors or parties quoting for the same purpose.

**A minimum \$ 85.00 NET Engineering Administrative Fee will apply for Custom Product Drawings**

**(Note: The first set of Custom product drawings will be free of charge)**

**A minimum \$ 120.00 NET Engineering Administrative Fee will apply for all Standard Product Drawings**

### 3. TERMS OF PAYMENT

For authorized customers; Orders at a \$ 75,000.00 threshold will require a mandatory 25% deposit. Orders over and above \$ 100,000.00 requires a mandatory (25%) deposit at time of order, a mandatory (25%) deposit prior to product shipment and the balance to be paid within thirty (30) days of date of shipment. Payment not be made to Palmieri when due, Palmieri reserves the right to charge Purchaser with interest on such overdue payments. Interest of 2% per month (24% per annum) is charged on all overdue accounts, unless otherwise specified. The charging of such interest shall not be construed as obligating Palmieri to grant any extension of time in the terms of payment. All goods remain the property of Palmieri, until balance is paid in full to Palmieri.

### 4. TITLE

Title to the goods or any part thereof shall not pass from Palmieri to Purchaser until all payments due hereunder have been duly made, except as otherwise expressly stipulated herein. The goods shall be and remain personal or moveable property, notwithstanding their mode of attachment to realty or other property. If default is made in any of the payments herein, Purchaser agrees that Palmieri may retain all payments which have been made on account of the purchase price as liquidated damages, and Palmieri shall be free to enter the premises where the goods may be located and remove them as Palmieri's property, without prejudice to Palmieri's right to recover any further expenses or damages Palmieri may suffer by reason of such nonpayment.

### 5. TAXES

Prices do not include Goods & Services Tax, Provincial or Municipal sales, use, value-added or similar tax. All applicable taxes are extra. Our Harmonized Sales Tax (HST) registration number is R104055066.

### 6. THE AGREEMENT

An acceptance and official confirmation of Purchasers' order by signing Palmieri's Order Confirmation the Purchaser therefore is accepting terms and conditions as expressed herein Palmieri's Terms and Conditions of Quote and Sale by Palmieri and shall constitute the complete agreement, subject to the terms and conditions of sale herein set forth, and shall supersede all previous quotations, orders or agreements.

### 7. LEAD TIME / DELIVERY / DELAYS

Lead time is determined only when final material/finish selection and drawing approvals are received by Palmieri from the client. The accuracy of Palmieri's lead times, is created to the best of our ability with the information provided to us. Confirmed lead time is conveyed to the client by means of Order Confirmation. They do not preclude the client from checking the accuracy of your requirement and our Order Confirmation. Any noted discrepancies are to be reported immediately to Palmieri Customer Service Department for correction and re-issue of revised Order Confirmation. By signing and dating the Order Confirmation the client accepts the terms and conditions of quote and sale.

Lead time on our Order Confirmation do not account for delays that could potentially occur for special materials specified by the client that are outside of our standard finishes and materials program that are out of our control and will affect the lead time on the order. Palmieri will notify the client immediately when these delays occur and adjust the lead time accordingly.

Delivery schedules are approximate and are based on prevailing market conditions applicable respectively at

the time of Palmieri's quotation and Palmieri's acceptance of clients' order, if certain portions of an order are completed by the quoted lead time while other portions have experienced delays outside of our control. The client may choose to part ship the order at their discretion and expense. Otherwise the entire order will ship with the delayed portion at a later date. Palmieri may extend delivery schedules or may, at its option, cancel Purchaser's order in full or in part without liability other than to return any deposit or prepayment which is unearned by reason of the cancellation.

### 8. CHANGES AND CANCELLATION

Orders accepted by Palmieri are not subject to changes or cancellation by Purchaser without the written consent of Palmieri. In such cases where Palmieri authorizes changes or cancellation, Palmieri reserves the right to charge the Purchaser with reasonable costs based upon expenses already incurred and commitments made by Palmieri, including, without limitation, any labour done, material purchased and also including Supplier's usual overhead and reasonable profit and cancellation charges from Palmieri's suppliers. Palmieri will communicate to the Purchaser additional costs incurred by way of Revised Order Confirmation. Revised Order Confirmation will include applicable costs incurred and modification to lead times (if applicable). The Purchaser must provide Palmieri written confirmation of additional costs, before any changes can be processed on the order.

**A minimum charge of \$ 100.00 NET Change Order Request fee will apply**

**A minimum charge of \$ 150.00 NET Cancel Order Request fee will apply**

### 9. SHIPPING LOCATION / SHIPPING QUOTES / COST OF TRANSPORTATION

Unless otherwise stated, all prices are F.O.B. our factory in Richmond Hill, Ontario, Canada.

Customary methods of transportation shall be selected by Palmieri and such transportation will be at Purchaser's expense. Shipping quotations are made at time of furniture quotation and are outside the control of Palmieri. **Shipping quotes are valid for ten (10) business days from the time of quote.** We do our best to maintain shipping costs as quoted, however all shipping weights and cubic feet shown are approximate only, various construction materials and packaging methods may add to the weights given. All quoted prices, unless otherwise stated on the quotation, are based on the current exchange rates, tariffs, fuel surcharges and costs of manufacture and are subject to change by Palmieri with or without notice until Purchaser's acceptance. Palmieri does not assume responsibility or liability for shipping costs, product during transit, or variances from the shipping weights or cubic feet shown in our specification guides. Special methods of transportation will be used upon Purchaser's request and at Purchaser's additional expense, provided reasonable notice of Purchaser's transportation requirements are given by Purchaser to Palmieri prior to shipment. Palmieri will notify the client prior to shipping product if shipping costs as quoted change, at which point the client must approve the adjusted shipping costs.

### 10. RECEIVING PRODUCT / REPORTING DAMAGE / STORAGE OF PRODUCT

Upon receipt of Palmieri product, the receiver of the goods must immediately inspect the product to ensure it is free of shipping damage. If the product is deemed in good order, the receiver of the product must ensure

to sign off on the accompanying carriers Bill of lading in good condition. Except for obligations stated under “Warranty” herein, Palmieri’s responsibility for the product ceases once the product has been received and signed off in good order and is the full responsibility of the receiver and subsequently the owner.

In the event shipping damage is discovered during receipt of shipment, it is the responsibility of the receiver to ensure all noted damage is recorded on the carrier’s Bill of Lading prior to sign off. All noted shipping damage claims must be reported to Palmieri within **24 hours** of receipt of the product onsite, failure to do so will result in the claim being deemed null and void. All shipping damage claims are to be reported directly to Palmieri’s Shipping Manager. Please call our toll free number at **1-800-413-4440 ext. 33** or submit the claim by Fax directly to **1-905-731-9878**. Palmieri will not accept any shipping damage claims submitted **after 24 hours** and it shall be conclusively presumed that the goods were delivered in good condition.

Storage of product, Palmieri will not be held responsible for any potential damages or shortages for product shipped and received by Purchaser and is subsequently placed into storage and not inspected within 24 hours of receipt.

## 11. INSTALLATION / SHORTAGES / BACK CHARGES

Unless otherwise expressly stipulated, the goods shall be installed by and at the risk and expense of Purchaser.

In the event that Palmieri is requested to supervise such installation, Palmieri’s responsibility shall be limited to exercising that degree of skill customary in the trade in supervising installations of the same type. Purchaser shall remain responsible for all other aspects of the work including compliance with the local regulations. It is the responsibility of the Purchaser to ensure hardware and parts are received in good order. Packing slip and hardware list to be provided by Palmieri with every order at time of shipping. Purchaser has the responsibility to notify Palmieri immediately without delay of issues that arise; subsequently Palmieri will take action to provide prompt resolution.

Shortages must be reported to Palmieri within **24 hours** of receipt of the goods and failure to do so may be at the expense of the Purchaser.

If deemed missing hardware and parts short shipped from the factory, Palmieri will arrange to ship freight prepaid to destination. Palmieri will only be responsible for replacement costs of missing hardware and parts, any labour costs incurred will be the responsibility of the Purchaser and will not be approved by Palmieri.

Back Charges will only be approved if we deemed a defect in the material or workmanship is found during the installation period resulting in a return trip to the job-site to complete installation. It shall remain the sole discretion of Palmieri to approve (A) repair or (B) replace the furniture and any labour costs incurred by the Purchaser.

## 12. FORCE MAJEURE

Palmieri shall not be responsible or liable for any loss or damage incurred by Purchaser herein resulting from causes beyond the reasonable control of Palmieri including, but without limitation, abuse, misuse or accident, alteration or modification of product by customer or third party, normal wear and tear, improper installation, handling or incorrect use, unauthorized repairs, the substitution of part components or hardware not approved or authorized by Palmieri, improper storage, and environmental conditions such as irregular temperature control

either inside or outside the environment, acts of God, fire, flood, delays in transportation, or the failure of Palmieri’s suppliers to meet their delivery promises. The acceptance of delivery of the goods by Purchaser shall constitute a waiver of all claims for loss or damage due to any delay whatsoever.

## 13. RETURNED GOODS

No goods may be returned to Palmieri for a credit or exchanged without Palmieri’s prior written consent.

Palmieri reserves the right to accept all returns and subject to a handling/restocking charge or to decline all returns. Even after Palmieri has authorized the return of goods for credit, Palmieri reserves the right to adjust the amount of any credit given to Purchaser on return of the goods based on the conditions of the goods on arrival in Palmieri’s warehouse. Credit for returned goods will be issued to Purchaser only where such goods are returned by Purchaser and not by any subsequent owner of the goods. Goods will be considered for return only if they are in their original condition and packaging. Palmieri Goods Return Authorization Form to be issued and **must** accompany all shipments returning back to the factory. **Return freight must be prepaid by Purchaser. A minimum 20% re-stocking fee will apply.**

# PALMIERI

create. communicate. collaborate.

---

Palmieri Furniture Ltd.

1230 Reid Street  
Richmond Hill  
Ontario Canada L4B 1C4

T: 905 731 9300  
F: 905 731 9878  
TF: 800 413 4440

E: [info@palmierifurniture.com](mailto:info@palmierifurniture.com)  
W: [www.palmierifurniture.com](http://www.palmierifurniture.com)